

ERSADMAK®

PVC AND ALUMINIUM PROCESSING MACHINES
PVC VE ALÜMİNYUM İŞLEME MAKİNALARI

ÜRÜN KATALOĞU
PRODUCT CATALOGUE

**MÜKEMMELİ
ARAYANLARA**

ERFAN MÜHÜR

HAKKIMIZDA

PVC & alüminyum işleme makinalarında kazandığımız tecrübe ve birikimi daha ileriye taşıyarak müşteri memnuniyetini ön planda tutup sektörde öncü firmalar arasına girmek ve ERSADMAK' ı en üst yerlere getirmek amacındayız. Daima kendisini yenilemekte olan, teknolojiyi takip eden firmamız kullanıcıya kolaylık sağlayan ve kaliteyi ön planda tutan sorunsuz makineler satışı yapmaktadır. ERSADMAK makina müşteri arz ve talepleri doğrultusunda kaliteyi ve satış sonrası güvenilir servis hizmetini kendisine politika edinmiştir.

ERSADMAK makina olarak vizyonumuz sektörümüzde KALİTE ve GÜVENİLİR hizmet denince akla gelen ilk isim olmaktır. Bundan dolayıdır ki ; ürünlerimiz ihtiyaç sahibi müşterilerimizin en iyi verimi almaları ve en ekonomik maliyetlerle iş yapmaları düşünülerek tasarlanmıştır. Yurt içi ve yurt dışı hizmet vermekte olan firmamız dünya çapında kaliteli Türk makinelerini müşterisine ulaştırmayı misyon edinmiştir. Bu amaçla makine sektöründeki yenilik ve değişmelere ayak uydurabilmek ve paralel bir seyir izlemek için her geçen gün teknolojisini geliştirerek ilerlemektedir.

ABOUT US

To increase customer satisfaction and to become one of the leading companies in the sector by taking the experience and accumulation we gained in PVC and aluminum processing machines We aim to bring ERSADMAK to the top places. Always renewing itself, following the technology of our company that provides convenience and quality in the foreground without problems machines for sale. ERSADMAK has adopted the policy of quality and reliable after-sales service in line with customer Our vision as

ERSADMAK machine is to be the first name that comes to mind when QUALITY and RELIABLE service is mentioned in our sector. That is why; Our products are in need of our customers designed with the best efficiency and the most economical costs. Our company is serving domestic and international quality machinery around the world has the mission to deliver to its customers. For this purpose, in order to keep up with the innovations and changes in the machine sector and to follow a parallel course, to advance.



SC 100

PVC ÇİFT KÖŞE KAYNAK MAKİNASI (0.2mm)
DOUBLE CORNER WELDING MACHINE (0.2mm)



Liner Kızak Sistemi
Linear Guide System



Minimum Kaynak Ölçüsü 29cm.
Minimum Welding Measure 29 cm.



Hareketli Profil Destek Kolları
Moving Profile Support Arms

- CE standartlarına uygundur.
- Sadeleştirilmiş makina yönetim panosu zaman tasarrufu sağlar.
- Maksimum kaynak mukavemeti sağlar.
- Kaplama profiller için hem normal hem 0,2 mm kaynak yapabilme imkanı
- Hareketli sağ kafa butonla sabitlenir.
- Kaynak yapılan profilin maksimum uzunluğu 3200 mm'dir
- Kolay kalıp değiştirme sistemi sayesinde zaman tasarrufu sağlar.
- Değişik profil türleri için ısı derecesi, kaynak zamanı ve basınç ayarlama imkanı sağlar.
- Isıtma ünitesi termostatik kontrol düzenine sahiptir.
- Isıtma plakasının derecesi dijital ekranından kolay değiştirilebilir.
- Güç kaynağı ani voltaj değişikliklerine karşı sistemi korur.

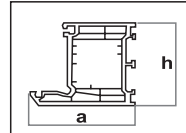

a max : 165
h min : 40
h max : 130

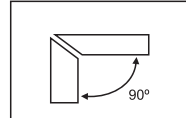



40
130

133

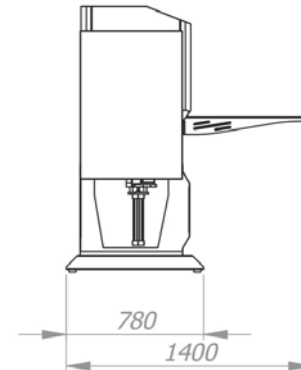
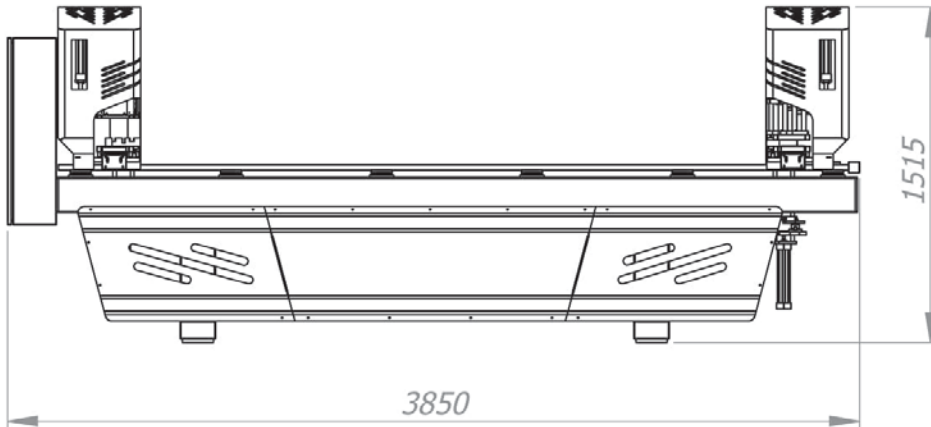
- Relevance with CE standards.
- Simplified machine operation panel, saving time.
- Maximum weld strength.
- Capability of both normal and 0,2 mm welding for coated profiles
- Movable right head is fixed with
- Maximum welding length 3200 mm
- Easy mold changing system
- Temperature, welding time and pressure adjustment for different type of profiles
- Heating unit with thermostatic control.
- Easy to change the degree of heating plate with digital display
- Power supply protects the system against sudden voltage changes.



 V = 380 Kw = 10	 Air 6 - B bar 70 lt/min	 kg 520 kg
---	--	---



- CE standartlarına uygundur.
- Kaynatılabilir açı: 25° - 180° arası tüm açılar.
- Üst pistonlar tek tek sıkıştırma imkânına sahiptir.
- Sol hareketli tablo sistemi mevcuttur.
- Profil sıkışması pratik şekilde pedal ile yapılır.
- Isıtma ünitesi termostatik kontrol düzenine sahiptir.
- Isıtma plakasının derecesi dijital ekranından kolay değiştirilebilir.
- Değişik profil türleri için ısı derecesi, kaynak zamanı ve basınç ayarlama imkanı vardır.
- Kolay kalıp değiştirme sistemi sayesinde zaman tasarrufu sağlar.

- Relevance with CE standards.
- Welding angles : All angles between 25-180
- Upper pistons can be clamped individually
- Movable left table
- Profile clamping is practicaly made by a pedal
- Heating unit with thermostatic control
- Easy to change the degree of heating plate with digital display
- Temperature , welding time and pressure adjustment for different type of profiles
- Easy mold changing system

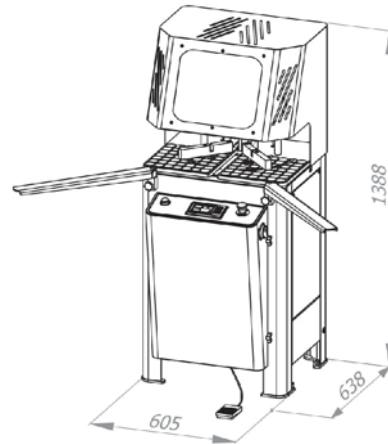

25 - 180° Arası Tüm Açıları Kaynatabilir.
It can boil all angles between 25 - 180 °.

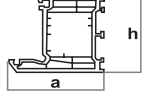
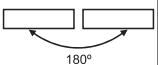

 V = 220 Kw = 5	 Air 6 - B bar 70 lt/min	 153 kg	 a max : 200 h min : 40 h max : 130	 180° 40 130 133
--	--	---	---	---



- CE standartlarına uygundur.
- Kaynatılabilir açı: 25° - 180° arası tüm açılar.
- Stabil ısı dağılımı ve uzun ömürlü ısıtıcı plakalar mevcuttur.
- Kaplamalı profiller için sıfır kaynak özelliği vardır.
- Tüm ısı ve zaman parametreleri birbirinden bağımsız olarak ayarlanabilir.
- Elektro-pnömatik kontrol sistemine sahiptir.
- Kolay değiştirilebilir tek parça teflonu sahiptir.
- Hareketli tablo lineer kızak sistemi mevcuttur.

- Relevance with CE standards
- Welding angles : All angles between 25-180
- Stable heat dissipation and long lasting heating plates
- Zero welding feature for coated profiles
- All the temperature and time parameters can be adjusted individually
- Electro pneumatic control
- Easy replaceable one-piece teflon
- Linear Sliding System Movable Table

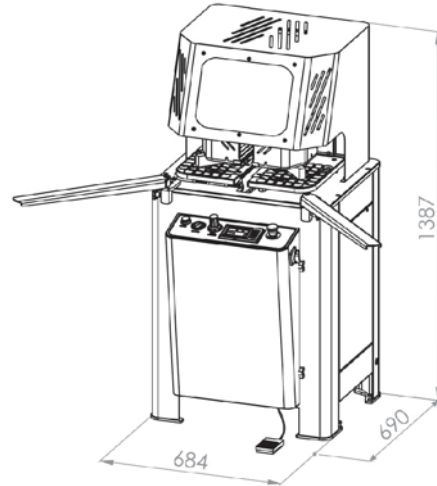

Liner Kızak Sistemi Hareketli Tablo
Linear Sliding System

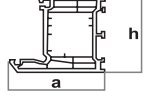
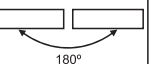

 V = 220 Kw = 5	 Air 6 - B bar 70 lt/min	 kg 152 kg	 a max : 200 h min : 40 h max : 130	 180° 40 130 133
--	--	---	---	---

- CE standartlarına uygundur.
- PVC Ve Alüminyum profillerinin orta kayıt bağlantılarının alıştırılması imkanı sağlar
- Pnömatik profil sıkıştırma sistemi
- Profil seçimine göre elmas bıçak kullanımı
- Freze motorunun pnömatik silindir ile hareket ettirebilme özelliği

Opsiyon

- Yan dayama presi
- Soğutma sistemi





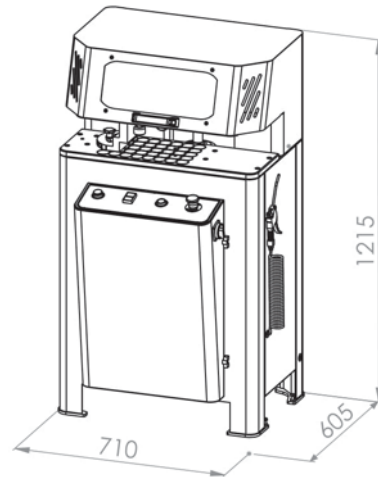

- Relevance with CE standards
- Possibility of familiarization of T profile connections
- Pneumatic profile clamping system
- Use of diamond-head blade according to profile selection
- The ability of the milling motor to be driven by pneumatic cylinder

Options

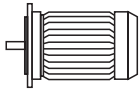
- Side gauge press
- Cooling system

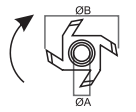

CE standartlarına uygun kullanım
Use according to CE standards

					
Hz = 50 Rpm = 2810 Kw = 1,1	V = 380 Kw = 1,1	Air 6 - 8 B bar 10 lt/min	92 kg	b max : 140 _{mm} a max : 30 n (1/min) : 2810	h max : 90

- CE standartlarına uygundur.
- PVC Ve Alüminyum profillerinin orta kayıt bağlantılarının alıştırılması imkanı.
- 30° kadar değişik açılarda profillerin orta kayıt bağlantılarının alıştırılması imkanı
- Pnömatik profil sıkıştırma sistemi
- Freze motorunun pnömatik silindir ile hareket ettirilebilme özelliği
- Ayırıcı buton sayesinde kolay seri deęiştirme.

Opsiyon

- Soęutma sistemi

- Relevance with CE standards
- Possibility of familiarization of T profile connections for both UPVC & Aluminum
- Possibility of familiarization of T profile connections at different angles up to 30°
- Pneumatic profile clamping system
- The ability of the milling motor to be driven by pneumatic cylinder
- Easy change of knives for different series with separator button





Option

- Cooling system

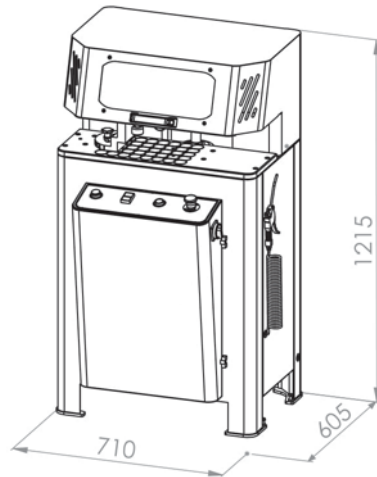

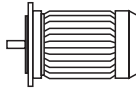
Dereceli Çift Seri Hareket Sistemi
Dual Series Motion System

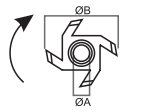
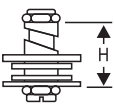

					
Hz = 50 Rpm = 2810 Kw = 1,1	V = 380 Kw = 1,1	Air 6 - 8 B bar 10 lt/min	kg 110 kg	b max : 140mm a max : 30 n (1/min) : 2810	h max : 90

SC 301

PVC ÇITA KESİM MAKİNASI PVC GLAZING BEAD CUTTING MACHINE



- CE standartlarına uygundur.
- PVC çita profillerinin 45° kesim imkanı
- Otomatik çalışma sistemi
- Uzun çerçeveler için metrajlı konveyör sistemi 2000 x 1
- Ayarlanabilir kesme hızı
- Pnömatik profil sıkıştırma sistemi
- Testere çapı : Ø200 mm

Opsiyon

- Sol konveyör takılabilme özelliği
- Tırnak testere

- Relevance with CE standards
- 45 ° cutting of PVC stave profiles
- Automatic operation system
- Meter conveyor system for long frames (2000 x 1)
- Adjustable cutting speed
- Pneumatic profile clamping system
- Saw diameter: (Ø200) mm





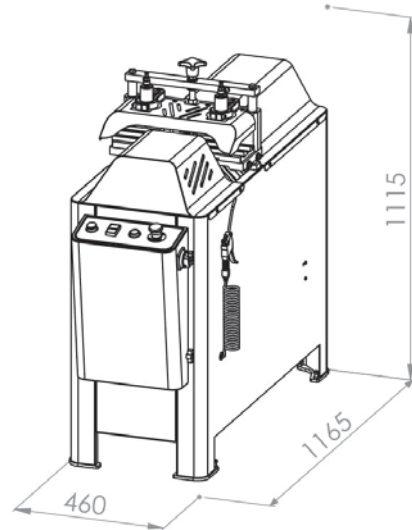

Option

- Left conveyor mountability
- Nail saw

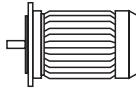

Kolay Ayarlanabilir Universal Kalıp
Easy-To-Set Universal Mold

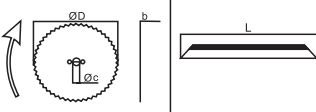

 Hz = 50 Rpm = 2810 Kw = 1,5	 V = 380 Kw = 1,5	 Air 6 - 8 B bar 10 lt/min	 kg 110 kg	 d max : 2x200 mm c max : 32 mm	 L max : 2550 mm L min : 300 mm H max : 28,3 mm
--	--	--	---	--	---

- CE standartlarına uygundur.
- Makine + 45° -45° ve ara derecelerde kesim yapabilir.
- 90°, 75°, 60°, 45° dereceler için hızlı ayarlama tamponları vardır.
- Ara dereceler için tablo sabitleme kolu mevcuttur.
- Profil sıkışması pnömatik sistemdir, pratik şekilde yapılır.
- Elmas Testere çapı Ø400mm'dir.
- Standart olarak ölçüm ve taşıma konveyörleri mevcuttur. (2m sağ – sol)

Opsiyon

- Alüminyum profil kesimi için Soğutma tertibatı
- Makaralı konveyör sistemi (3mt sağ-sol)

- Relevance with CE standards
- The machine can cut at + 45 °, -45 ° and intermediate degrees.
- Quick adjustment bumpers for 90 °, 75 °, 60 °, 45 ° degrees
- Table fixing lever for intermediate degrees
- Profile jamming is practically done by a pneumatic system,
- Diamond shape saw diameter is Ø400mm.
- Measuring and transport conveyors are available as a standard (2m right - left)



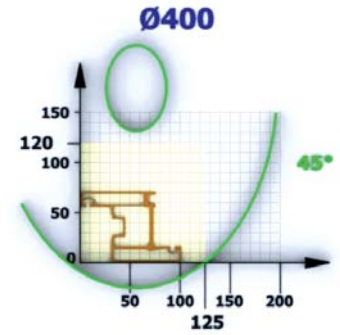
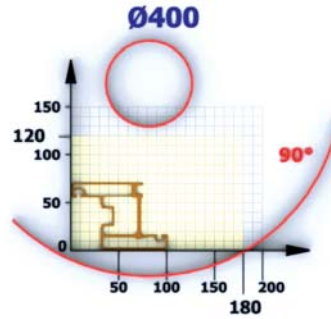
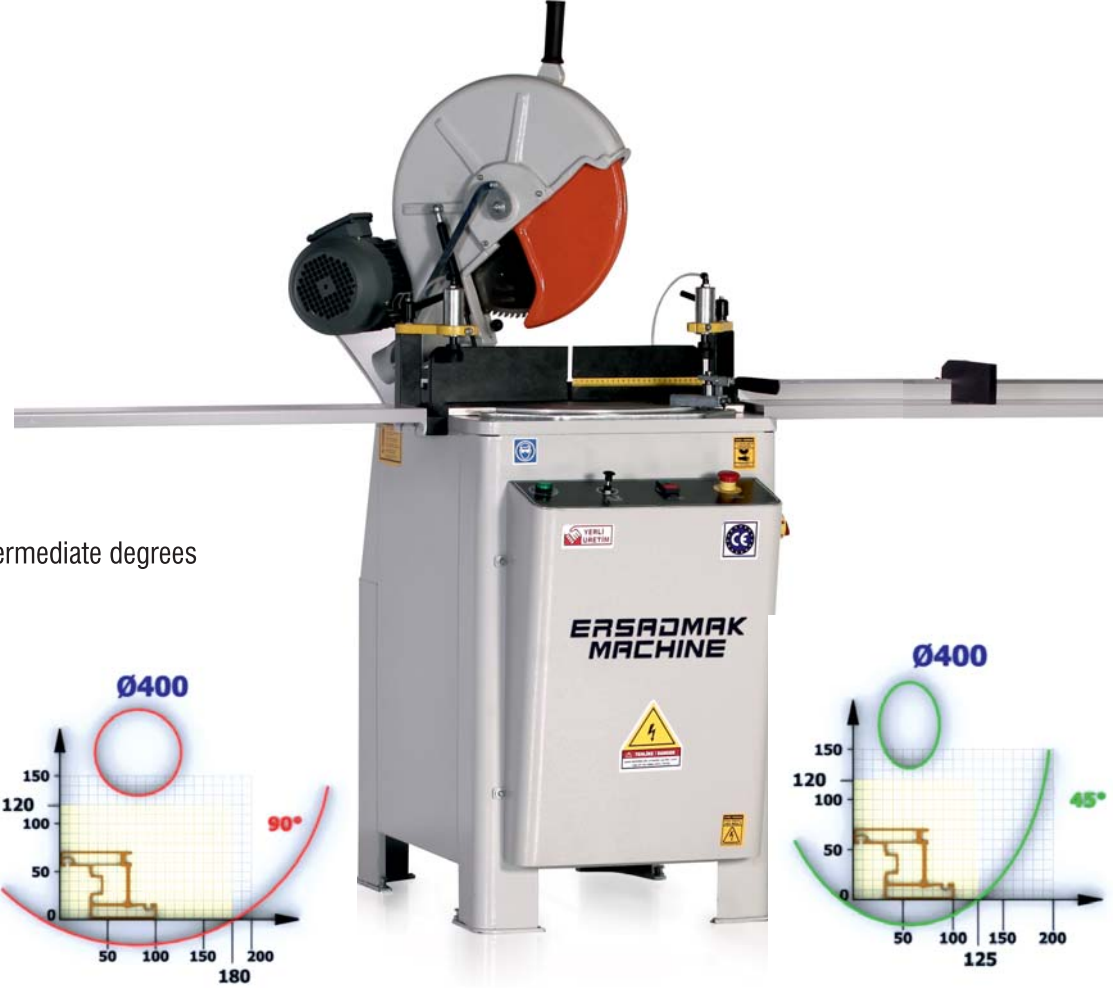

Option

- Cooling system for aluminum profile cutting
- Roller conveyor system (3mt)

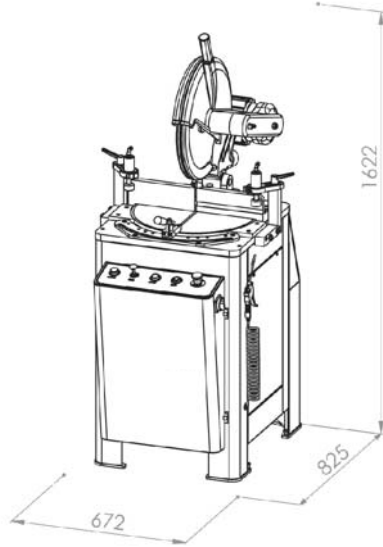

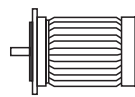
Çapaksız Alüminyum Kesimi
Aluminum Extrusion Without Anchors

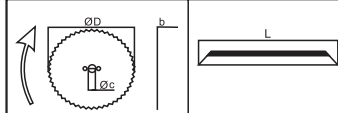
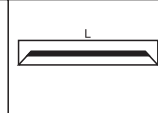

 Hz = 50 Rpm = 2810 Kw = 2,2	 V = 380 Kw = 2,2	 Air 6 - 8 B bar 2,2 lt/min	 kg 150 kg	 d max : 400 mm c max : 32 mm	 L max : 3300 mm L min : 360 mm
--	--	---	---	--	--

SC 400

ALÜMİNYUM PVC ÇİFT KAFA KESİM MAKİNASI (Ø450mm)
ALUMINIUM PVC DOUBLE HEAD CUTTING MACHINE (Ø450mm)



Dokunmatik Ekran
Touch Screen



45 - 90° Otomatik Çift Kafa
45 - 90° Automatic Double Head

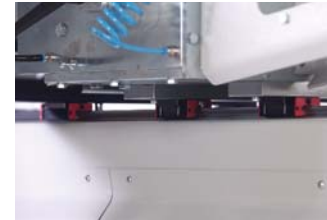

Lineer Kızak Sistemi
Linear Guide System

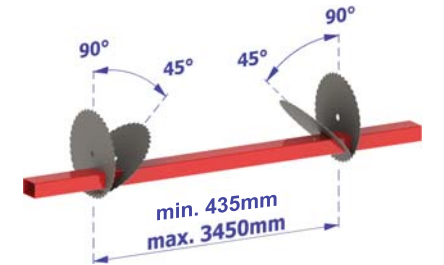

- CE standartlarına uygundur.
- PVC ve alüminyum profillerin 45°- 90° ve ara derecelerde çift taraflı hassas kesimini yapar
- Makina 45° - 90° derecelerde otomatik, diğer ara derecelerde kolay ayarlama imkânı sağlar
- PLC kontrol sistemi
- Kesim adedi ve ölçüsünü içeren 10000 adım hafıza kapasitesi
- 4mt'den uzun profillerin otomatik kesim için 6mt programı
- Alüminyum takoz dilimleme programı
- Çoklu dil desteği
- Sol kafa sabit, sağ kafa hareketlidir
- Tek kafa ve çift kafa çalıştırma imkânı
- Ayarlanabilir kesim hızı
- Elmas testere çapı 450 mm
- Testere çıkış mesafesi 135 mm olup çift 62mmx2 profil kesim imkanı sağlar
- Emniyetli kesim kapakları pnömatik sistemi ile otomatik olarak çalışır
- Güç kaynağı ani voltaj değişikliklere karşı sistemi korur

Opsiyon:

- CO — Kesim Optimizasyonu: USB bellek üzerinden data transfer
- Servo motorlu yüksek hassasiyetli hareket sistemi (+/- 0,1mm)
- HMI kontrol paneli
- Barkod okuyucu

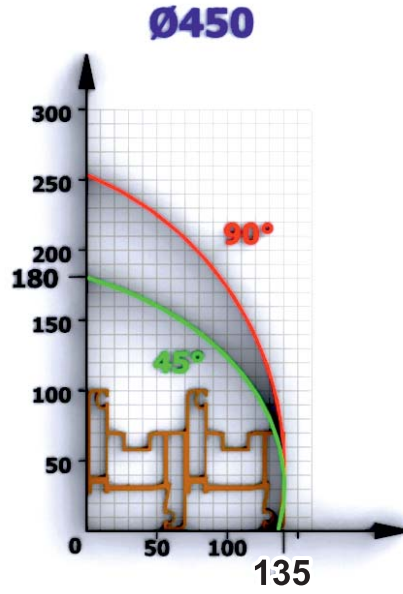



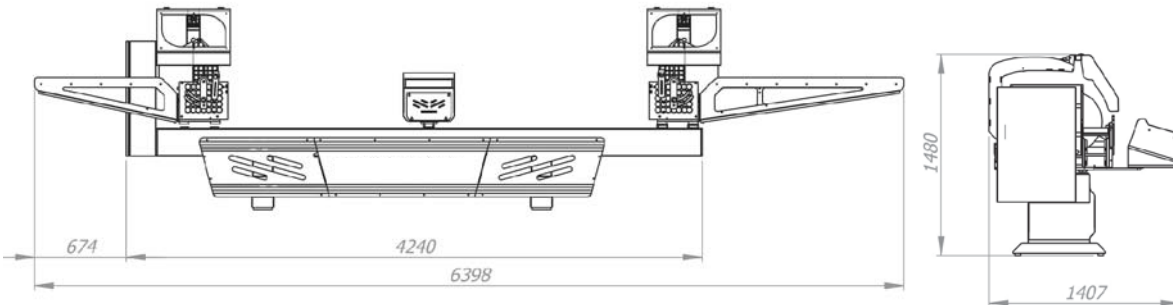

- Relevance with CE standards
- Makes double-sided precision cutting of PVC and aluminum profiles at 45 ° - 90 ° and intermediate degrees.
- The machine provides automatic adjustment in 45 ° - 90 ° degrees and easy adjustment in other intermediate degrees.
- PLC Kontrol control system
- Edi 10000-step memory capacity including number and size of cuts
- 6mt program for automatic cutting of profiles longer than 4mt
- Aluminum Wedge Slicing Program
- Multi-language support
- Left head fixed, right head movement
- Single head and double head operation
- Adjustable cutting speed
- 450 Diamond saw diameter 450 mm
- The saw output distance is 135 mm. Provides 62mmx2 profile cutting
- Safe cutting covers work automatically with pneumatic system
- The power supply protects the system against surge voltage changes

Option

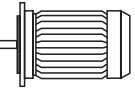
- CO - Cutting Optimization Data transfer via USB memory
- High precision motion system with servo motor (+/- 0.1mm)
- HMI control panel
- Barcode Printer

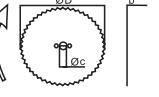

 Hz = 50 Rpm = 2810 Kw = 2x2,2	 V = 380 Kw = 6	 Air 6 - 8 B bar 30 lt/min	 kg 750 kg	 d max : 2x450 mm c max : 32 mm
--	--	--	---	--

SC 4000 S

FULL OTOMATİK SERVO MOTORLU ÇİFT KÖŞE ALÜMİNYUM PVC KESİM MAKİNASI (Ø550mm)
FULL AUTOMATIC SERVO MOTOR DOUBLE CORNER ALUMINIUM PVC CUTTING MACHINE (Ø550mm)



45-90° Otomatik Kafalar
45-90° Automatic Heads



Hareketli Konveyör Sistemi
Moving Conveyor System



Hassas Kesim İçin Üst Baskılar
Top Printing for Precision Cutting





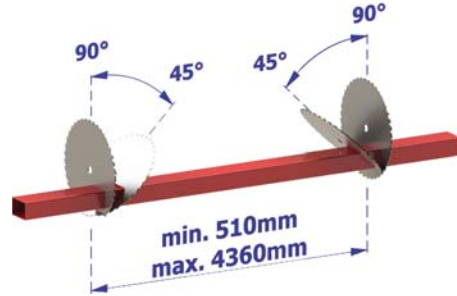
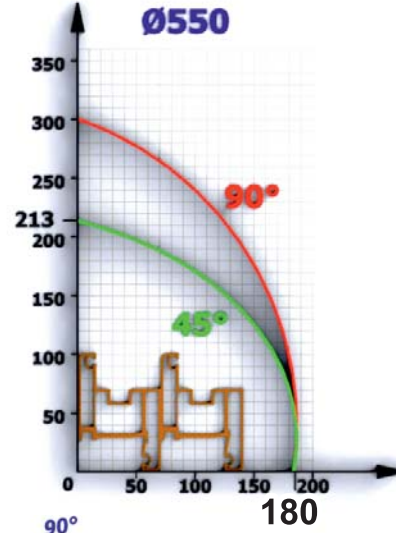

Lineer Kızak Sistemi
Linear Guide System

- CE standartlarına uygundur.
 - PVC ve alüminyum profilleri, düz veya açılı olarak, çift kafa Ø 550 mm.
 - Testere ile kesmek amacı ile tasarlanmış tam otomatik kontrollü kesme makinesidir.
 - Hidro- pnömatik Hidrocheak kontrollü testere hareketi
 - Kesme hassasiyeti +/- 0.1 mm.
 - 90° ve 45° içe iki açığa otomatik olarak ayarlanabilir.
 - 90° açıda otomatik dilimleme
 - Dokunmatik renkli panel ekran
 - Uzaktan bağlanma ve teknik destek sağlama
 - 2x Ø550 mm testere
 - Servo motor hareket sistemi
 - 18 cm Testere çıkış mesafesi olup 80mmx2 profil kesimi
 - Hidrocheak testere hız ayarı
 - 8 metre kesim özelliği
 - Çoklu dil desteği
 - Sınırsız ölçü hafıza kapatıscısı
 - Püskürtmeli, testere soğutma sistemi
 - 2 x dikey mengene
 - 4 x yatay mengene
- OPSIYON**
- Barkod yazıcı
 - USB bellek üzerinden data transferi

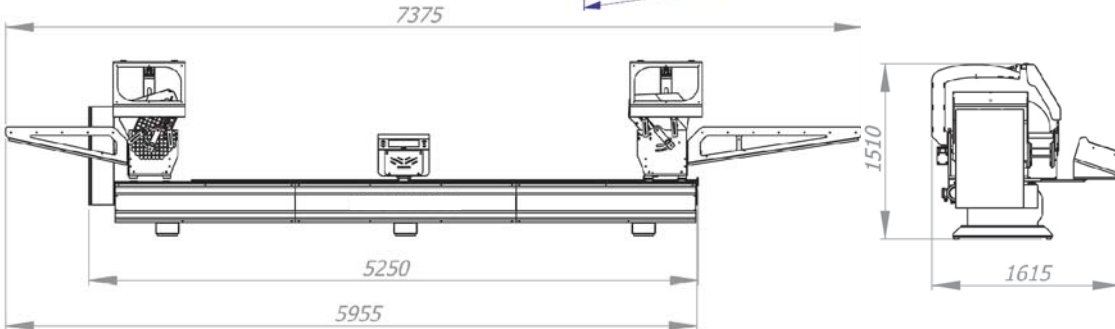

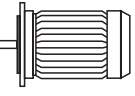
- Complies with CE standards
 - PVC and Aluminum profiles, straight or angled, double head Ø 550 mm is a fully automatic controlled cutting machine designed to cut with a saw.
 - Hydro-pneumatic hydrocheak controlled saw motion
 - Cutting accuracy +/- 0.1 mm
 - Automatically adjustable to 90 ° and 45 ° in two angles
 - Automatic slicing at 90 ° angle Windows based industrial PC and 10 've touch color panel display
 - Remote connectivity and technical support
 - 2x Ø550 mm saw blade
 - Servo motor motion system
 - 18 cm saw output distance and 80mmx2 profile cutting
 - Hydrocheak saw speed adjustment
 - 8 Meter cutting feature
 - Multi-language support
 - Unlimited memory footprint
 - Spray, saw cooling system
 - 2 x vertical vise
 - 4 x horizontal vise
- Option**
- Barcode printer
 - Data transfer via USB memory

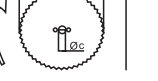

 Hz = 50 Rpm = 2810 Kw = 2x3,0	 V = 380 Kw = 8	 Air 6 - 8 B bar 30 lt/min	 kg 1150 kg	 d max : 2x550 mm c max : 32 mm
--	--	--	--	--

SC 401

ALÜMİNYUM PVC ALT TAN ÇIKMA KESİM MAKİNASI (Ø450mm) ALUMINIUM PVC UNDERCUT CUTTING MACHINE (Ø450mm)



- CE standartlarına uygundur.
- 15°, 22.5°, 30°, 45°, 60°, 90° dereceler için hızlı ayarlama tamponları
- Ara dereceler için tabla sabitleme kolu
- Testere çıkış hızı regülatörü alüminyum kesiminde hızı yavaşlatıp motor yüklenmesini azaltır.
- Elmas testere çapı 450 mm.
- Standart olarak ölçüm ve taşıma konveyörleri mevcuttur. (2 mt. sağ- sol)

Opsiyon

- Alüminyum profil kesimi için soğutma tertibatı
- Alüminyum profile kesimi için Hidrocheak sistemi.

- Relevance with CE standards
- Quick adjustment bumpers for 15 °, 22.5 °, 30 °, 45 °, 60 °, 90 ° degrees
- Tray fixing lever for intermediate grades
- The saw output speed regulator slows the speed in aluminum cuts and reduces engine loading
- Diamond saw blade diameter 450 mm
- Measurement and transport conveyors are available as standard. (2 mt. Right-Left)





Option

- Cooling system for aluminum profile cutting
- Hydrocheak system for aluminum profile cutting.

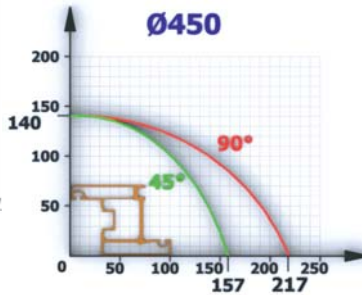
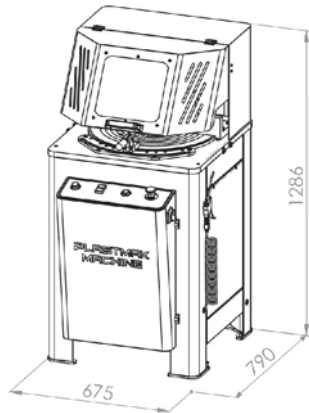

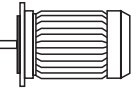
0-90° arası hassas kesim
Precise cutting between 0-90 °

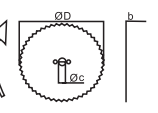

 Hz = 50 Rpm = 2810 Kw = 1,1	 V = 380 Kw = 1,1	 Air 6 - 8 B bar 41 lt/min	 kg 150 kg	 d max : 450 mm c max : 32 mm
--	--	--	---	--

SC 402

FULL OTOMATİK ALÜMİNYUM PVC ALTTAN ÇIKMA KESİM MAKİNASI (Ø550mm) FULL AUTOMATIC ALUMINIUM PVC UNDERCUT CUTTING MACHINE (Ø550mm)





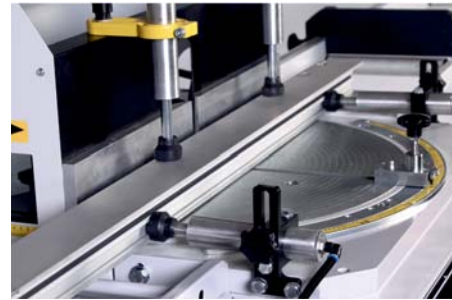

- CE standartlarına uygundur
- Alüminyum, PVC profillerin kesim işlemleri için kullanılır.
- Hidro-Pnomatik kesim işlemi,
- Profile göre kesim hızını ayarlama
- Sağ ve sola -60°, -45°, -30°, -22,5°, -15°, 0°, +15°, +22,5°, +30°, +45°, +60°
- Sabit açılarda kesim yapabilir.
- Pnomatik dikey ve yatay mengene (PRES)
- Q 550 mm elmas uçlu alüminyum testere.
- Sağ 3 mt / Sol 3 mt makaralı konveyör mevcuttur.
- Yağ püskürme sistemi.
- 3 KW motor ve hidrocheak sayesinde hassas kesim yapabilir.

- Relevance with CE standards
- Used for cutting Aluminum & PVC profiles.
- Hydro-pneumatic cutting process,
- Adjustable cutting speed according to the profile.
- Right and Left -60°, -45°, -30°, -22,5°, -15°, 0°, +15°, +22,5°, +30°, +45°, +60°
- Cutting at fixed angles.
- Pneumatic, vertical and horizontal press
- Ø 550 mm Diamond Tipped Aluminum Saw.
- Roller Conveyor Available (Right-Left 3 mt)
- Oil Spray System.
- 3 KW Motor And Hydrocheaks providing Precision Cutting.

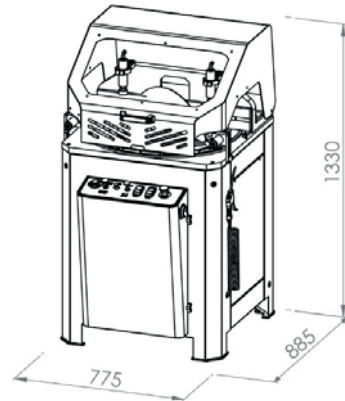

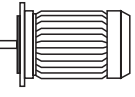
Yatay ve dikey pistonlar
Horizontal and vertical pistons

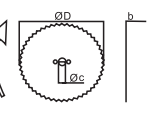

 Hz = 50 Rpm = 2810 Kw = 3,0	 V = 380 Kw = 3,0	 Air 6 - 8 B bar 41 lt/min	 kg 210 kg	 d max : 550 mm c max : 32 mm
--	--	--	---	--





- CE standartlarına uygundur.
- PVC profillerin kilit yerleri, menteşe yarıkları, kol yeri delikleri ve su tahliye kanalı açılması imkanı Kopya kafasının düşey ekseninde çalışma özelliği
- Üçlü delme sisteminin yatay ekseninde çalışma özelliği
- Su tahliye sisteminin açılı pozisyonda çalışma özelliği
- Universal şablon isteğe bağlı şablon yapabilme imkanı
- Üçlü delme kopya freze ya da kanal açma sisteminin tek olarak çalışabilme imkanı
- Kuvvetli motor sayesinde rahat çalışabilme imkanı mevcuttur.
- Sağ konveyör sistemi (1 mt)

- Relevance with CE standards
- Possibility of opening of hinge slots, lever holes and water discharge channel of PVC profiles, Operation of the copy head on the vertical axis
- Operation of triple drilling system on horizontal axis
- Angle position of water drain system Universal template optional template
- Ability to work with triple drilling, milling or grooving system
- Easy operation thanks to strong motor
- Right conveyor system (1 mt)

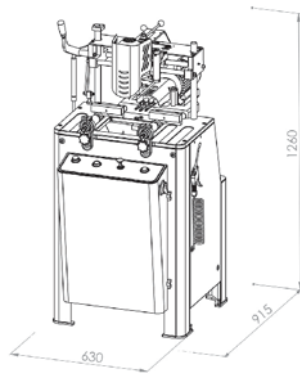

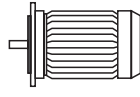
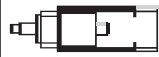
Motorların birbirinden bağımsız çalışma özelliği
Independent operation of motors



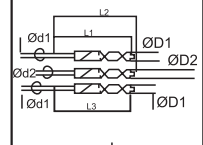
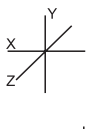

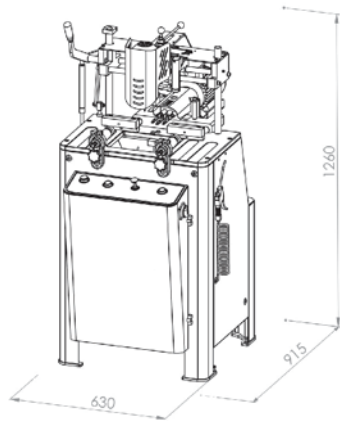

 Hz = 50 Rpm = 2810 Kw = 2,2	 Hz = 50 Rpm = 12000 Kw = 0,6	 V = 380 Kw = 2,5	 Air 6 - 8 B bar 9 lt/min	 kg 130 kg	 L1 : 110 L2 : 110 L3 : 110 ØD1 : 11 ØD2 : 12 Ød1 : 8 Ød2 : 8	 Lmin : 80 Ød1 : 5 Ød2 : 8 x : 280 y : 125 z : 90
---	---	--	---	---	---	--

- CE standartlarına uygundur.
- PVC profillerin kilit yerleri, menteşe yarıkları, kol yeri delikleri ve su tahliye kanalı açılması imkanı Kopya kafasının düşey ekseninde çalışma özelliği
- Üçlü delme sisteminin yatay ekseninde çalışma özelliği
- Su tahliye sisteminin açılı pozisyonda çalışma özelliği
- Universal şablon isteğe bağlı şablon yapabilme imkanı
- Üçlü delme kopya freze ya da kanal açma sisteminin tek olarak çalışabilme imkanı
- Kuvvetli motor sayesinde rahat çalışabilme imkanı mevcuttur.
- Sağ konveyör sistemi (1 mt)

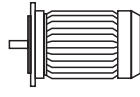
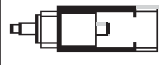
- Relevance with CE standards
- Possibility of opening of hinge slots, lever holes and water discharge channel of PVC profiles, Operation of the copy head on the vertical axis
- Operation of triple drilling system on horizontal axis
- Angle position of water drain system Universal template optional template
- Ability to work with triple drilling, milling or grooving system
- Easy operation thanks to strong motor
- Right conveyor system (1 mt)

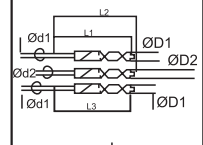
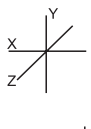
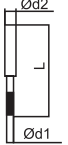

							
Hz = 50 Rpm = 2810 Kw = 2,2	Hz = 300 Rpm = 18000 Kw = 0,75	V = 380 Kw = 3,0	Air 6 - 8 B bar 9 lt/min	130 kg	L1 : 110 L2 : 110 L3 : 110 ØD1 : 11 ØD2 : 12	Ød1 : 8 Ød2 : 8	Lmin : 80 Ød1 : 5 Ød2 : 8 x : 280 y : 125 z : 90

Yüksek performanslı freze çakıları
High-performance milling cutters the

- CE standartlarına uygundur.
- PVC profillerin kilit yerleri, menteşe yarıkları, kol yeri delikleri açma imkanı.
- Kopya kafasının düşey ekseninde çalışma özelliği
- Üçlü delme sisteminin yatay ekseninde çalışma özelliği
- Universal şablon isteğe bağlı şablon yapabilme imkanı
- Üçlü delme kopya freze ya da kanal açma sisteminin tek olarak çalışabilme imkanı
- Kuvvetli motor sayesinde rahat çalışabilme

Opsiyon

- Sağ konveyör sistemi 1 metre
- Soğutma sistemi

- Relevance with CE standards
- Possibility to open the lock locations of PVC profiles, hinge slots, arm holes.
- Operation of the copy head on the vertical axis
- Operation of triple drilling system on horizontal axis
- Universal template, optional template
- Ability to work with triple drilling, milling or grooving system
- Comfortable operation thanks to strong engine





Option

- Right conveyor system 1 meter
- Cooling system

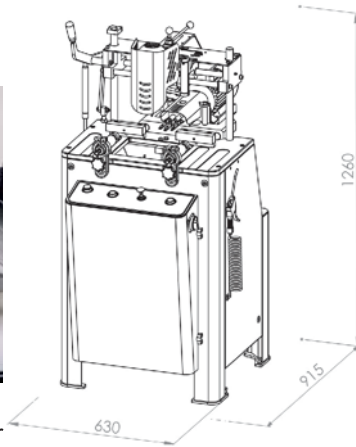

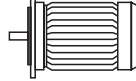
Birbirinden bağımsız çalışan matkaplar
Running drills are independent of each other

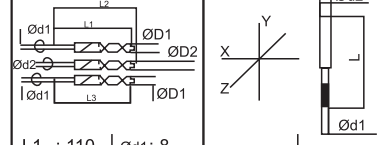

					
Hz = 50 Rpm = 2810 Kw = 2,2	Hz = 50 Rpm = 12000 Kw = 0,75	V = 380 Kw = 3,0	Air 6 - 8 B bar 9 lt/min	122 kg	L1 : 110 L2 : 110 L3 : 110 ØD1: 11 ØD2: 12
					Ød1: 8 Ød2: 8
					Lmin : 80 Ød1 : 5 Ød2 : 8
					x : 280 y : 125 z : 90

- CE standartlarına uygundur.
- PVC profillerin kilit yerleri, menteşe yarıkları, kol yeri delikleri açma imkanı.
- Kopya kafasının düşey ekseninde çalışma özelliği
- Üçlü delme sisteminin yatay ekseninde çalışma özelliği
- Universal şablon isteğe bağlı şablon yapabilme imkanı
- Üçlü delme kopya freze ya da kanal açma sisteminin tek olarak çalışabilme imkanı
- Kuvvetli motor sayesinde rahat çalışabilme
- Yüksek frekanslı motor. (18000 devir)
- Soğutma sistemi

Opsiyon

- Sağ konveyör sistemi 1 metre

- Relevance with CE standards
- Possibility to open the lock locations of UPVC profiles, hinge slots, arm holes.
- Operation of the copy head on the vertical axis
- Operation of triple drilling system on horizontal axis
- Universal template, optional template possibility
- Ability to work with triple drilling, milling or grooving system
- Comfortable operation with powerfull motor
- High frequency motor. (18000 cycles)
- Cooling system



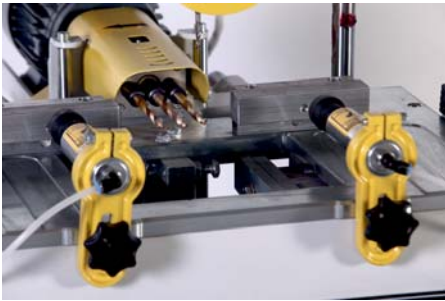

Option

- Right conveyor system 1 meter

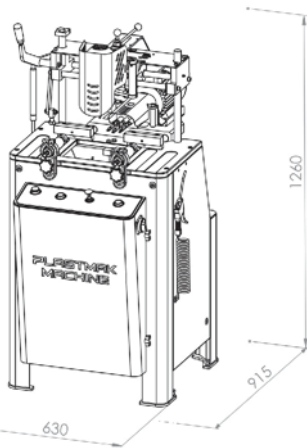

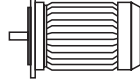
Yüksek performanslı freze çakıları
High-performance milling cutters the

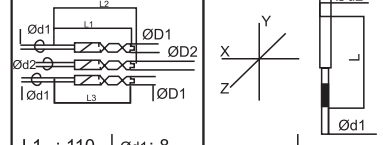

					
Hz = 50 Rpm = 2810 Kw = 2,2	Hz = 300 Rpm = 18000 Kw = 0,75	V = 380 Kw = 3,0	Air 6 - 8 B bar 9 lt/min	130 kg	L1 : 110 L2 : 110 L3 : 110 ØD1 : 11 ØD2 : 12
					Ød1 : 8 Ød2 : 8 Lmin : 80 x : 280 Ød1 : 5 Ød2 : 8 y : 125 z : 90

- Tüm profillerin kol kilit vs. işlemlerinde kullanılır.
- İleri teknoloji motor desteği ile rahat çalışır.
- Çapaksız ve rahat işleme hızına sahiptir.
- Su soğutma sistemi üzerinde mevcuttur.
- Özel işlem amaçlı farklı kopya şablonu yapılıdır.
- Pnömatik profil sıkıştırma sistemlidir.

Opsiyon

- Sağ konveyör sistemi (1 mt)



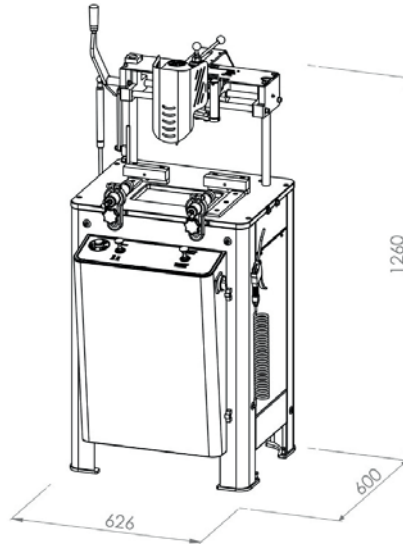

- Relevance with CE standards
- Used in operations of profiles' arms, locks, etc.
- It works comfortably with advanced technology motor support.
- It has a burr-free and comfortable processing speed.
- Water cooling system is available.
- Pneumatic profile clamping system.

Option

- Right conveyor system (1 mt)

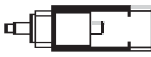

Soğutma sistemi
Cooling system

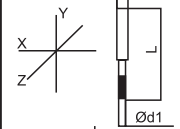
				
Hz = 50 Rpm = 12000 Kw = 0,75	V = 220 Kw = 0,75	Air 6 - 8 B bar 9 lt/min	105 kg	Lmin : 80 Ød1 : 5 Ød2 : 8 x : 280 y : 125 z : 90

- Tüm profillerin kol kilit vs. işlemlerinde kullanılır.
- İleri teknoloji motor desteği ile rahat çalışır.
- Çapaksız ve rahat işleme hızına sahiptir.
- Yüksek frekanslı motor (18000 devir)
- Su soğutma sistemi üzerinde mevcuttur.
- Özel işlem amaçlı farklı kopya şablonu yapılır.
- Pnömatik profil sıkıştırma sistemli.

Opsiyon

- Sağ konveyör sistemi 1 metre

- Relevance with CE standards
- Used in operations of profiles' arms, locks, etc.
- It works comfortably with advanced technology motor support.
- It has a burr-free and comfortable processing speed.
- Water cooling system is available.
- Pneumatic profile clamping system.
- High frequency motor (18000 rpm)





Option

- Right conveyor system (1 mt)

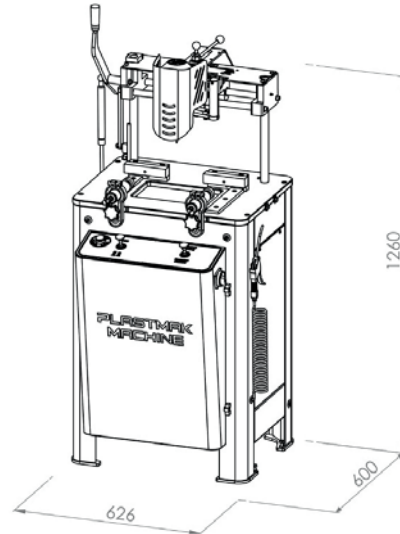

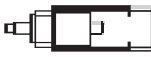
Hassas sürücü sistemli
Precision drive system

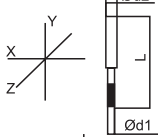

 Hz = 300 Rpm = 18000 Kw = 0,75	 V = 220 Kw = 0,75	 Air 6 - 8 B bar 9 lt/min	 105 kg	 Lmin : 80 Ød1 : 5 Ød2 : 8 x : 280 y : 125 z : 90
---	---	---	---	--

SC 5000 S

ALÜMİNYUM PVC 3 EKSEN CNC FREZE MAKİNASI ALUMINUM PVC 3 AXIS CNC MILLING MACHINE



Spindle motor
Spindle engine



Soğutma sistemli
With cooling system



Dokunmatik ekran
Touch screen







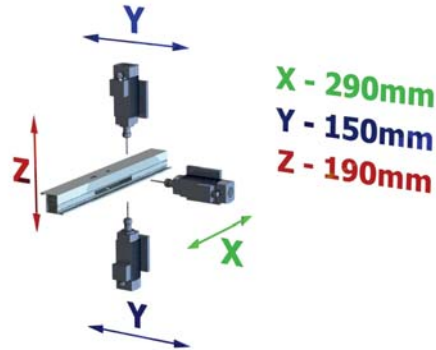
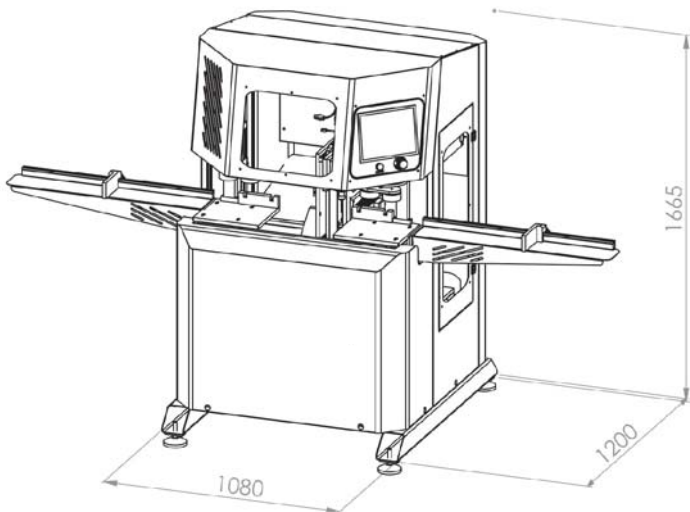

Çapaksız işlem
Non-curvature operation

- CE standartlarına uygundur
- Alüminyum ve PVC profillerin kapı, kanat, kol barel ve üçlü delme işlemini yapabilen makinedir.
- CNC kontrolü 10" dokunmatik ekran
- Birbirinden bağımsız 3 eksen (AXIS)
- X, Y, Z eksenlerde servo motor sistemi
- G kod ile çalışabilme
- Alüminyum profiller için soğutma sistemi
- Sağ, sol kol ve dayamalı metraj sistemi
- Lineer kızak sistemi hassas çalışabilme
- Bütün işlemlerin hız ayarları yapılabilme
- Dokunmatik ekran dan Alüminyum PVC profili kolay geçebilme ve hız ayarlarını otomatik değişmesi
- Sınırsız hafıza kapasitesi

- Relevance with CE standards
- It is the machine which can make door, wing, arm bar and triple drilling process of aluminum and PVC profiles.
- CNC control 10 touch screen
- Independent 3 AXIS
- Servo motor system in X, Y, Z axes
- Working with G code
- Cooling system for aluminum profiles
- Right, left arm and restraint system
- Precise operation with linear guide system
- Speed adjustment of all operations
- Easy transition from touch screen from aluminum to PVC profile and automatic change of speed settings.
- Unlimited memory capacity







 <p>Hz = 300 Rpm = 18000 Kw = 0,75</p>	 <p>V = 220 Kw = 0,75</p>	 <p>Air 6 - 8 B bar 9 lt/min</p>	 <p>510 kg</p>	 <p>Lmin : 80 Ød1 : 5 Ød2 : 8</p>	 <p>x : 280 y : 125 z : 90</p>
---	--	---	---	--	---

- CE standartlarına uygundur
 - PVC profillerinin su tahliye kanalı açılması imkanı
 - Üç grubun ayrı ayrı çalışma imkanı
 - Su tahliye sisteminin açılı pozisyonda çalışma özelliği
 - Pnömatik profil sıkıştırma sistemli
 - Tam otomatik sistemli
-
- Relevance with CE standarts
 - Possibility of opening drain channels of UPVC Profiles
 - Ability to operate three groups separately
 - Possibility of water drain system to work in angle position
 - Pneumatic profile clamping system
 - Full automatic system

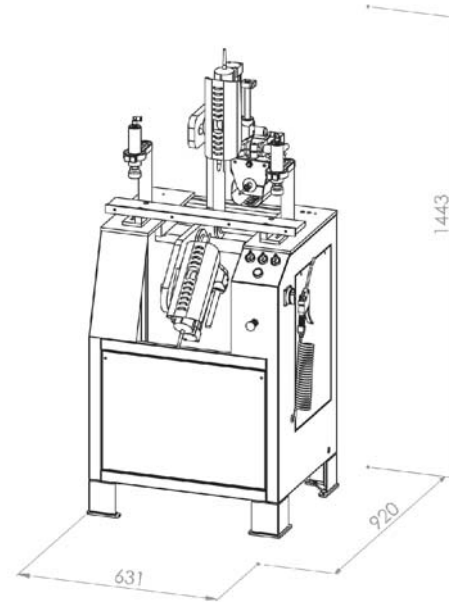

Birbirinden bağımsız çalışabilen motorlar
Engines that can operate independent of each other



 Hz = 50 Rpm = 12000 Kw = 3x0,9	 V = 220 Kw = 3	 Air 6 - 8 B bar 22 lt/min	 kg 120 kg	 Lmin : 80 Ød1 : 5 Ød2 : 8 x : 280 y : 125 z : 90
---	--	--	---	--

SÇ 601

PVC KÖŞE TEMİZLEME MAKİNASI (3 BİÇAK) PVC CORNER CLEANING MACHINE (3 KNIVES)







- CE standartlarına uygundur
 - PVC profillerinin kaynak sonrası köşelerinin temizlenmesi
 - Köşelerin alt üst ve dış yüzeylerin temizlenmesi
 - Akrilik profilleri için yüzey ve köşe temizleme işlemini ayrılabilirliği
 - 3 değişik bıçak bağlama imkanı
 - Otomatik kasa kanat profillerini ayırma özelliği
 - Profilin gönyeye dayanmasının ve profilin merkezlenmesinin otomatik olarak yapabilirliği
-
- Relevance with CE standards
 - Cleaning of post-welded corners of PVC profiles
 - Cleaning of upper and lower surfaces of corners
 - Separation of surface and corner cleaning process for acrylic profiles
 - 3 different blade mounts
 - Automatic frame & panel profile separation
 - The ability to automatically adjust the profile and center the profile.

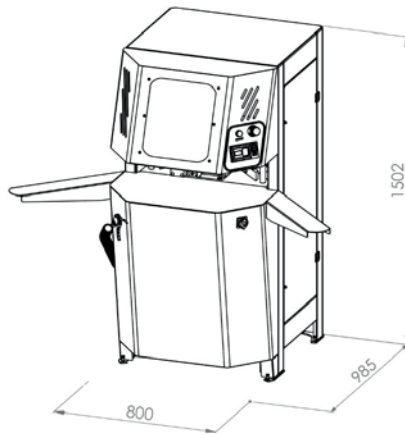

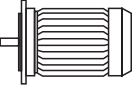
Rulmanlı sistemli kazıma
Roller scraping system

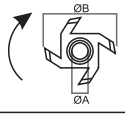
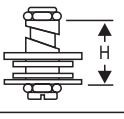
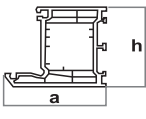

 Hz = 50 Rpm = 2810 Kw = 1,1	 V = 380 Kw = 2	 Air 6 - 8 B bar 11 lt/min	 kg 197 kg	 b max : 210mm a max : 32 n (1/min) : 2810	 h max : 90	 a max : 125 h min : 40 h max : 90
---	--	--	---	---	---	--

SC 6000

PLC KONTROLLÜ YARI OTOMATİK CNC KÖŞE TEMİZLEME MAKİNASI (2 AKSLI)
PLC CONTROLLED SEMI AUTOMATIC CNC CORNER CLEANING MACHINE (2 AXLES)



Elmas uçlu daire testere
Diamond Tipped Circular Saw

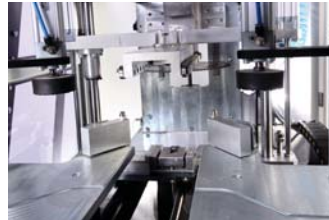

Rulmanlı kazıma sistemi
Bearing scraping system

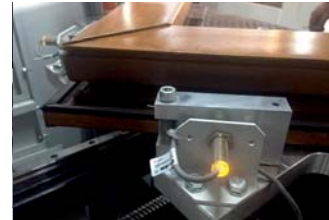

Sensörlü profil dayama
Sensor profile hold





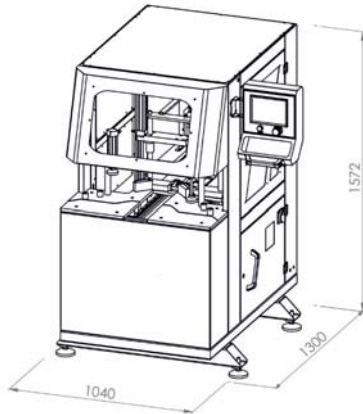

Dokunmatik ekran
Touch screen

- CE standartlarına uygundur
- 90° açılı ile kaynatılmış PVC pencere kanat kapı kasa ve diğer profillerin kaynak sonrası oluşan çapakları temizlemek için tasarlanan yarı otomatik CNC makinesidir.
- Birbirinden bağımsız profilin alt üst ve dış yüzeyini temizleme işlemi
- Dokunmatik ekran paneli
- Kolay hafızaya alabilme işlemi
- Kullanıcı tarafından rahat ayarlanabilir işlem hızları
- Makinede özel program sayesinde temizlenecek profilin programını yazma kolaylığı
- PLC üniteli NC kontrol sistemi
- Joystick kol saatinde kullanıcı y - z eksenleri kolay program oluşturabilme ve hassas ayar yapabilme imkanı
- Makinanın tek köşede ortalama işlem süresi 5-8 saniyedir
- 8 saatlik ortalama çalışmada 400 500 adet çerçeve temizleme imkanı
- Sınırsız program yükleme hafızası
- Günlük aylık üretim raporu gösterge paneli
- Makinede 2 adet Servo ve 1 adet spindle motor mevcuttur
- Ø250mm Elmas dişli Testere
- Bütün PVC profilleri açılı ve radius yapabilme özelliğine sahip ve dairesel interpolasyon hareketine sahiptir.
- Ön fırçalı sehpa sistemi sayesinde profillerin çizilmesi engellenerek hareket anında rahatlık sağlayabilir

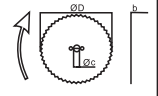
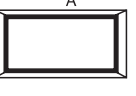
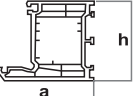

- Relevance with CE standards
- A semi-automatic CNC machine designed to clean the burrs formed after welding of door frame and other 90 ° welded profiles
- The process of cleaning the lower, upper and outer surfaces of the independent profile
- Touch screen panel
- Easy memory operation
- User-adjustable processing speeds
- Easy to write program to be cleaned with special program in the machine
- NC control system with PLC unit
- Easy to create and fine-tune at y - z axis with the joystick wristwatch
- The average machining time in one corner of the machine is 5-8 seconds.
- 400 500 frame cleaning facilities for 8 hours average operation
- Unlimited program load memory
- Daily monthly production report dashboard
- There are 2 Servo and 1 spindle engine in the machine.
- Ø250mm Diamond Head Saw
- All PVC profiles have angular and radial making and circular interpolation movement
- Pre-brush to prevent scratching of the profile thanks to the system to provide comfort at the time of movement

						
Hz = 300 Rpm = 18000 Kw = 1,4	V = 220 Kw = 7	Air 6 - 8 B bar 40 lt/min	kg 390 kg	D max : 250mm c max : 32 b : 2.0	A min : 350 B min : 350	a max : 150 h max : 200





- CE standartlarına uygundur.
- Alüminyum profillerinin 90° birleştirme işlemleri için tasarlanmış köşe presi makinesidir.
- 2 adet üst pres ve bıçak hareketi pnömatiktir.
- Bıçakların yüksekliği ve ilerlemesi için mm cetvel sistemi mevcuttur
- Merkezleme gönye takozu otomatiktir.
- Hassas ayar için tahliye butonu mevcuttur
- Pnömatik preslerin profili sıkması için 2 adet pedal kullanılır.
- Profil yüzeylerinin hasar görmemesi için polyamid levha vardır.
- Yan destek kolları mevcuttur.

- Relevance with CE standards
- Corner press machine designed for assembly of aluminum profiles at 90 °
- Pneumatic 2 upper presses and blade movement
- There is a mm ruler system for the height and progression of the blades.
- Centering miter chock is automatic.
- Release button for fine adjustment.
- Pneumatic presses use 2 pedals to tighten the profile
- Polyamide plate to prevent damage to profile surfaces
- Side support arms available

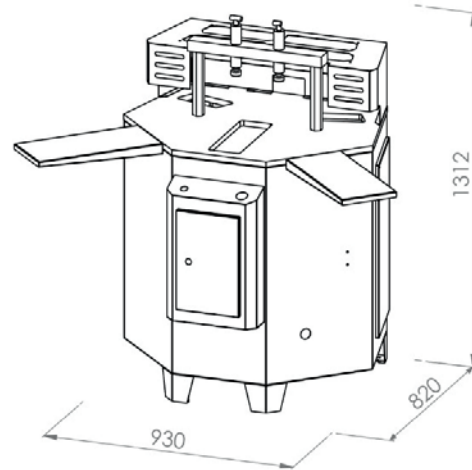

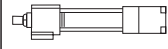
Gizli ön dayama
Hidden front gauge



 Hydropneumatic pressure Bar 100-120	 Air 6 - 8 B bar 12 lt/min	 kg 320 kg	 KGP ↓ Crimping Fors kg*f 3250
--	--	---	--



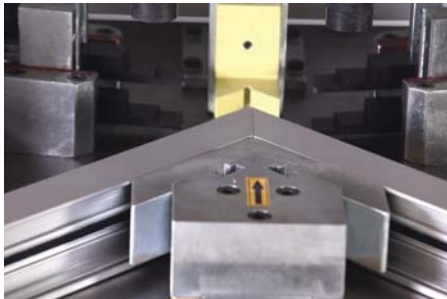

- CE standartlarına uygundur.
- Alüminyum profiller 90° birleştirme işlemleri için tasarlanmış köşe pres makinasıdır.
- 2 adet üst pres ve bıçak hareketi hidroliktir.
- Bıçakların yüksekliği ce ilerlemesi için mm cetvel sistemi mevcuttur.
- Merkezleme gönye takozu hidroliktir.
- Hassas ayar için tahliye butonu mevcuttur.
- Hidrolik pres ve profil sıkılamak için 2 adet pedal kullanılır.
- Profil yüzeyleri hasar görmemesi için polyamid levha vardır.
- Profil destek için sağ ve sol kolları mevcuttur.

- Relevance with CE standards
- It is designed for 90° jointing Aluminum profiles' corners
- 2 upper presses and blade movements are hydraulic.
- There is a mm ruler system for the height and progression of the blades.
- Centering miter wedge is hydraulic.
- Release button for fine adjustment.
- Two presses are used for hydraulic press and profile clamping.
- There is polyamide plate to prevent damage to the profile surfaces.
- Right and left arms are available for profile support.

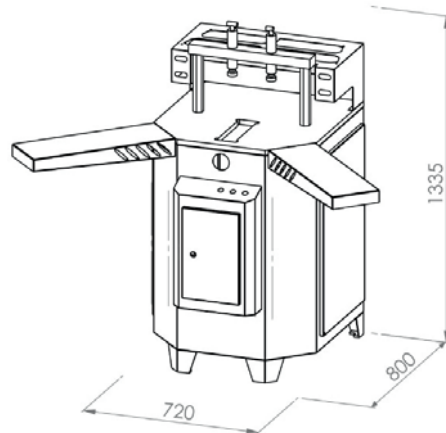

Hassas ayar yapabilme özelliği
Precision adjustment feature

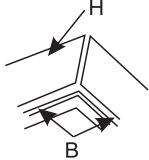
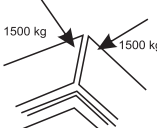

 V = 380 Kw = 2,2	 Air 6 - B bar 20 lt/min	 Air max 100 B bar	 kg 300 kg	 H : 130 mm	 min 7 bar 1500 x 2 kg
--	--	---	---	---	---

SC 441

PORTATİF KESİM MAKİNASI Ø300 mm
PORTABLE CUTTING MACHINE Ø300 mm

220 V



Alüminyum, PVC profillerinin kesim işlemleri için kullanılır
Çift yay sistemi ve testere muhafaza emniyeti kesim
Üst tabloda kesim -45° ve + 45° arasında istenen tüm açılarda kesim
Sağa ve sola 0°, 15°, 22,5°, 30°, 45° açı sabitleme

Opsiyon

Alt dolap gövde sistemi
Sağ sol metrelik sistemi
Pnömatik pres ve soğutma sistemi
Elmas üçlü testere

Used for cutting Aluminum & PVC profiles
Double spring system and saw guard safety cut
Cutting at the top table
Cutting at all desired angles between -45 ° and + 45 °
Right and left 0 °, 15 °, 22.5 °, 30 °, 45 ° angle fixing

Option

Bottom cabinet body system
Right left-meter system
Pneumatic press and cooling system
Diamond Triple Saw

SC 221

PORTATİF KERTME MAKİNASI
PORTABLE AND MILLING MACHINE

220 V



Alüminyum ve plastik profil orta kayıt alıştırmaya çarpma işlemleri için kullanılır
Dikey ve yatay mengene sistemi
Monofaze motor 220v

Opsiyon

Alt dolap gövde sistemi
Havalı sistem takılabilir

Possibility of familiarization of T profile connections for both UPVC & Aluminum
Possibility of familiarization of T profile connections at different angles up to 30 °
Pneumatic profile clamping system
The ability of the milling motor to be driven by pneumatic cylinder
Easy change of knives for different series with separator button

Option

Cooling system

SC 551

PORTATİF FREZE MAKİNASI
PORTABLE MILLING MACHINE

220 V



Alüminyum plastik profillere kilit kol yeri, ve menteşe, ispanyolette yuvaları ve istenilen boyutta kanal açma işlemi için kullanılır.
Yapacağınız işleme uygun kopya tertibatı
Dayama yardımı ile kopya tertibatından bağımsız olarak
Çeşitli kanal açma özelliği

Opsiyon

Alt dolap sistemi
Havalı sistem

It is used for aluminum & plastic profiles for lock, arm, and hinge, espagnolette slots and grooving in any desired size.
Copy device suitable for your process
Various grooving features independent of the copy setup with the help of the stop

Option

Bottom cabinet system
Pneumatic system

SÇ 1000

DİJİTAL KONVEYÖR DIGITAL CONVEYOR



3 m uzunluk
+- 0,1 mm ölçü hassasiyeti
220 V gerilim ile çalışmaktadır
Dokunmatik ekran
Kesilen ürün kalıptan rahat alınabilmesi sağlayan tek tuşa basarak dayamanın geri çıkma özelliği
Kullanım kolaylığı sağlayan tasarım
Kolay kalibrasyon

3 m length
+-0.1 mm accuracy
works with 220 V voltage.
Touch screen
Taking out the cutted item by single push button
Easy mounting to the machines
User freindly ergonomic design
Easy calibration



Her Makinaya Kolay Montaj
Easy to assamble to all the machines



SÇ 1001

MAKARALI KONVEYÖR ROLLER CONVEYOR

ÜRETİM AKIŞINI SAĞLAYAN TEK KAFALI GRUP
PRODUCTION GROUP PROVIDES SINGLE HEAD FLOW

ERSADMAK[®]
PVC AND ALUMINIUM PROCESSING MACHINES
PVC VE ALÜMİNYUM İŞLEME MAKİNELERİ



SÇ 401 ALÜMİNYUM PVC ALT TAN ÇIKMA KESİM MAKİNASI (Ø450mm)
ALUMINIUM PVC UNDERCUT CUTTING MACHINE (Ø450mm)



SÇ 501 ALÜMİNYUM PVC KOL YERİ DELME SU TAHLİYE MAKİNASI
ALUMINIUM PVC TRIPLE GRIP SLOT DRILLING AND WATER COPY ROUTER MACHINE



SÇ 101 PVC TEK KÖŞE KAYNAK MAKİNASI
SINGLE CORNER WELDING MACHINE



SÇ 301 ALÜMİNYUM PVC ÇİTA KESİM MAKİNASI
ALUMINIUM PVC GLAZING BEAD CUTTING MACHINE



SÇ 201 ALÜMİNYUM PVC ORTA KAYIT ALIŞTIRMA MAKİNASI (1 BİÇAK)
ALUMINIUM PVC END MILLING MACHINE (1 KNIFE)



SÇ 601 OTOMATİK KÖŞE TEMİZLEME MAKİNASI
AUTOMATIC CORNER CLEANING MACHINE

ÜRETİM AKIŞINI SAĞLAYAN ÇİFT KAFALI GRUP PRODUCTION GROUP PROVIDES DOUBLE HEAD FLOW

ERSADMAK
PVC AND ALUMINIUM PROCESSING MACHINES
PVC VE ALÜMİNYUM İŞLEME MAKİNELERİ



FULL OTOMATİK SERVO MOTORLU ÇİFT KÖŞE ALÜMİNYUM KESİM MAKİNASI (Ø550mm)
FULL AUTOMATIC SERVO MOTOR DOUBLE CORNER ALUMINIUM CUTTING MACHINE (Ø550mm)

SÇ 4000S



SÇ 211

ALÜMİNYUM PVC ORTA KAYIT ALIŞTIRMA MAKİNASI (2 BİÇAK)
ALUMINIUM PVC END MILLING MACHINE (2 KNIFE)



SÇ 100

PVC ÇİFT KÖŞE KAYNAK MAKİNASI (0,2mm)
DOUBLE CORNER WELDING MACHINE (0,2mm)



SÇ 301

ALÜMİNYUM PVC ÇİTA KESİM MAKİNASI
ALUMINIUM PVC GLAZING BEAD CUTTING MACHINE



SÇ 5000S

ALÜMİNYUM PVC 3 EKSEN CNC FREZE MAKİNASI
ALUMINIUM PVC 3 AXIS CNC MILLING MACHINE



SÇ 6000

CNC KÖŞE TEMİZLEME MAKİNASI
CNC CORNER CLEANING MACHINE



www.ersadmak.com

Yunusemre Mh. Karadut. Sk.
No: 42 Yıldırım / BURSA - TURKEY
+90 224 360 00 35
+90 532 503 46 43
ersadmak@hotmail.com

