

### Baymat Matbaa Malzemeleri

1

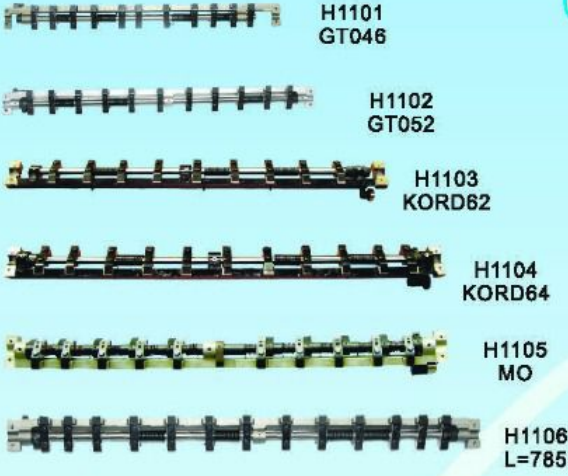

### Baymat Matbaa Malzemeleri

2

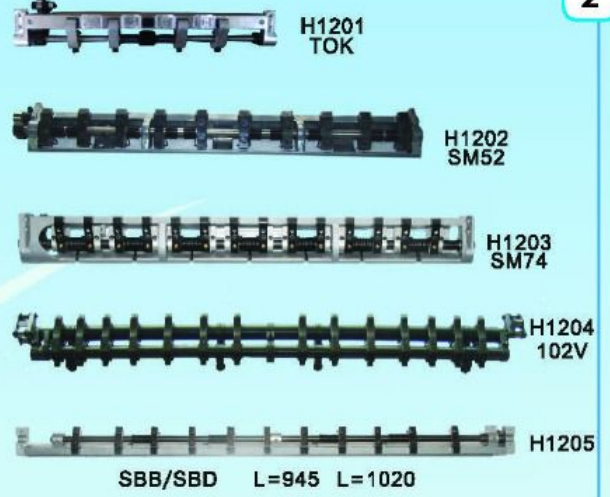

### Baymat Matbaa Malzemeleri

3



### Baymat Matbaa Malzemeleri

4

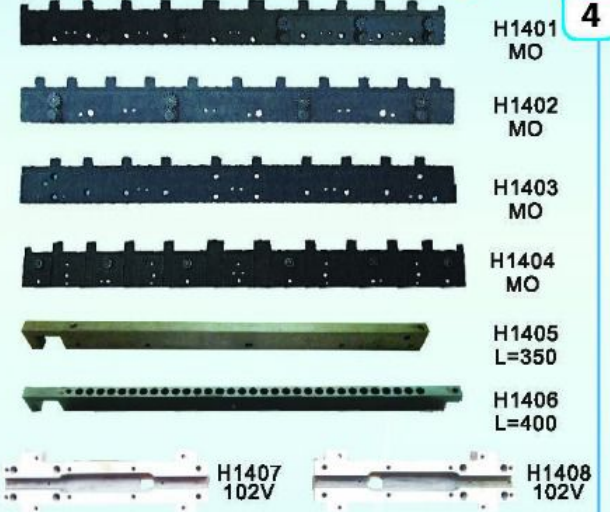

### Baymat Matbaa Malzemeleri

5

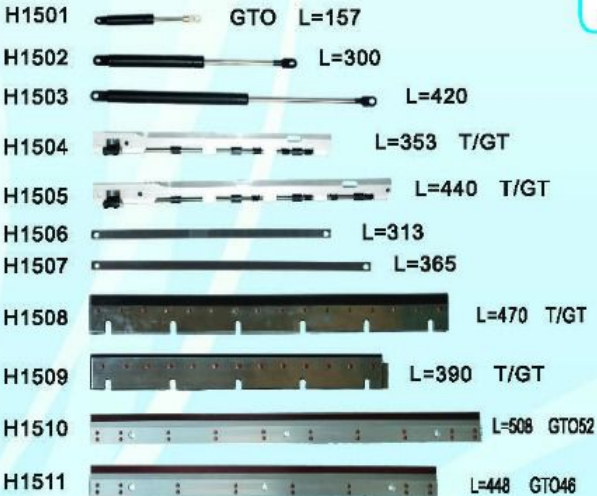

### Baymat Matbaa Malzemeleri

6

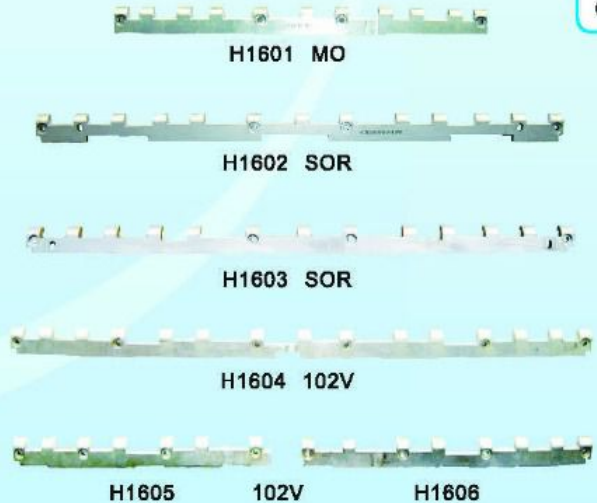

Baymat Matbaa Malzemeleri

1

SM102

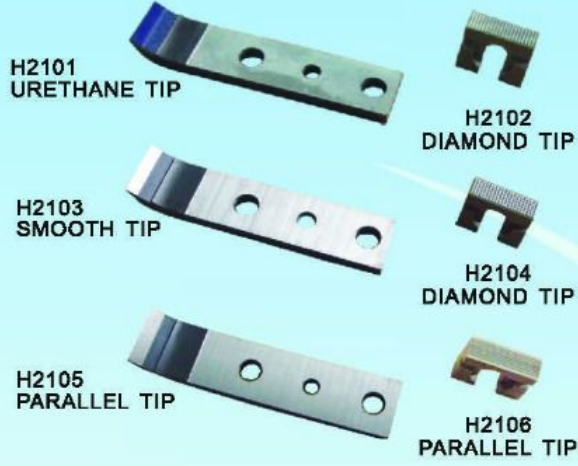

Baymat Matbaa Malzemeleri

2

CD102



Baymat Matbaa Malzemeleri

3

H2301 H2303 H2305 H2306

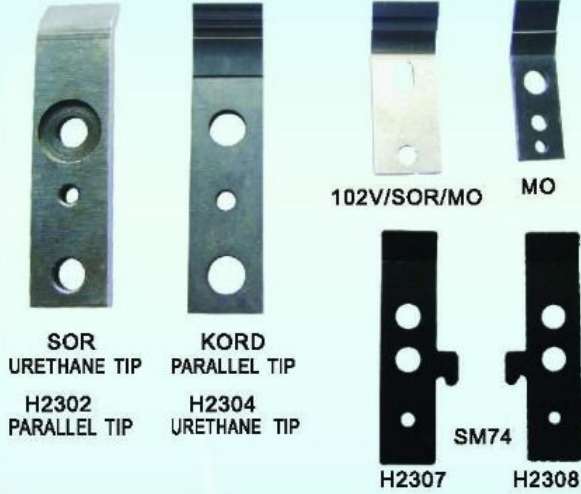

Baymat Matbaa Malzemeleri

4

H2401 H2402 H2403 H2404 H2405 H2406

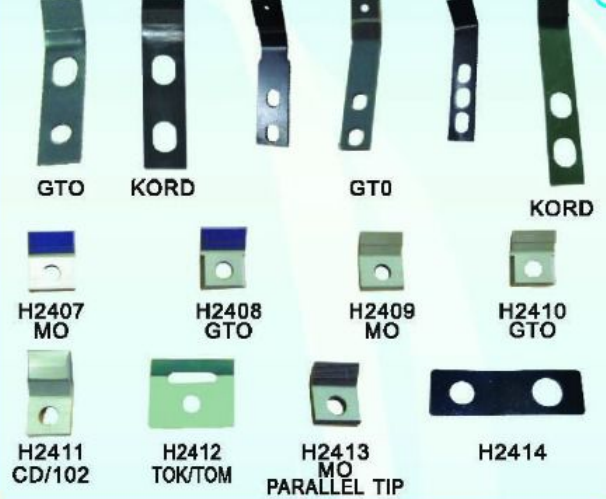

Baymat Matbaa Malzemeleri

5



Baymat Matbaa Malzemeleri

6



Baymat Matbaa Malzemeleri

1

H3101



H3102



GTO52

H3103



H3104

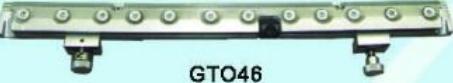

GTO46

Baymat Matbaa Malzemeleri

2

H3201



MO

H3202

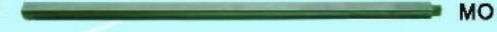

MO

H3203



H3204



GTO46 MULTICOLOR

Baymat Matbaa Malzemeleri

3

H3301



H3302



GTO52

H3303



H3304



GTO46

Baymat Matbaa Malzemeleri

4

H3401



H3402



GTO52

H3403



H3404

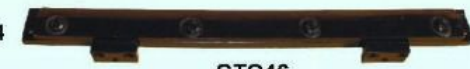

GTO46

Baymat Matbaa Malzemeleri

5

H3501



H3502



KORD64



H3503  
SM74/SM102

H3504



H3505

H3506  
102V



Baymat Matbaa Malzemeleri

6

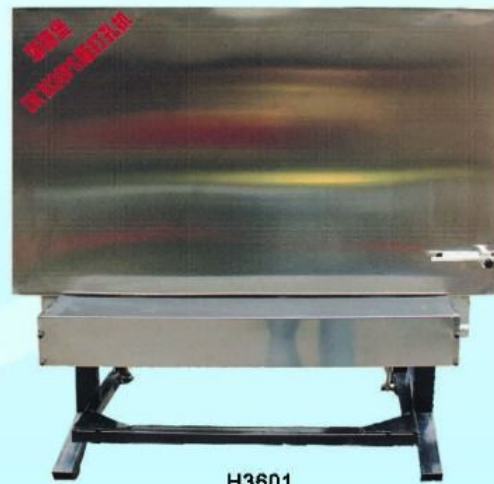

H3601

Baymat Matbaa Malzemeleri



Baymat Matbaa Malzemeleri



Baymat Matbaa Malzemeleri



Baymat Matbaa Malzemeleri



Baymat Matbaa Malzemeleri













Baymat Matbaa Malzemeleri

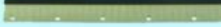

Baymat Matbaa Malzemeleri

1

H5101		GT046
H5102		GT052
H5103		KORD62
H5104		KORD64
H5105		MO
H5106		SM52
H5107		SM72
H5108		SM74
H5109		SOR
H5110		102V
H5111		102V





Baymat Matbaa Malzemeleri

2

H5201		GTO46
H5202		GTO52
H5203		MO
H5204		102V
H5205		L=40
H5206		L=109
H5207		L=75

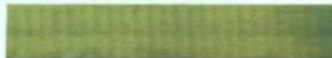
Baymat Matbaa Malzemeleri

3

H5301		GT046
H5302		GT052
H5303		GT046
H5304		GT052
H5305		KORD64





Baymat Matbaa Malzemeleri

4

H5401		102V
H5402		102V
H5403		SM74
H5404		SM74
H5405		MO
H5406		GTO
H5407		GTO
H5408		
H5409		
H5410		KOMPACII SYSTEMS GTO/MO
H5411		TOK

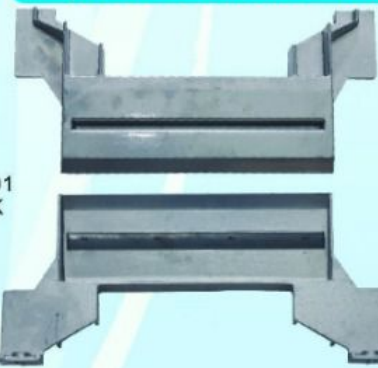



Baymat Matbaa Malzemeleri

5

H5501		TOK
H5502		L=282
H5503		
H5504		
H5505		H5505

Baymat Matbaa Malzemeleri

6

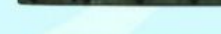
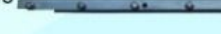
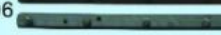
H5601		}GT046
H5602		}GT052
H5603		}MO
H5604		}SM72
H5605		}SM74
H5606		}SOR
H5607		}102V

Baymat Matbaa Malzemeleri

1



H6101  
F-34097



H6102  
F-4346.1



H6103  
F-83518



H6104

Baymat Matbaa Malzemeleri

2



H6201  
GTO/MO



H6202  
102V



H6203  
102V



H6204  
KORD



H6205  
CD102



H6206

Baymat Matbaa Malzemeleri

3



H6301  
F-53125



H6302  
F-53272



H6303  
F-217813.2



H6304  
F54293



H6308  
L=100



H6305  
F-94474



H6306  
F-52408



H6307  
F-214617



H6309  
F-87592



H6310  
F-207624



H6311  
F-208089.2

Baymat Matbaa Malzemeleri

4



H6401  
MO/GTO



H6402 102V



H6403 102V



H6404



H6405  
HK1512  
HK1516



H6406



H6407  
F-54635



H6408  
CS203



H6409  
F-42446



H6410  
F-29260



H6411  
F-213584



H6412  
63005

Baymat Matbaa Malzemeleri

5



H6501



H6502  
CD102



H6503



H6504



H6505



H6506



H6507



H6508



H6509

Baymat Matbaa Malzemeleri

6



H6601  
18Z



H6602  
31Z



H6603  
37Z



H6604  
25Z



H6605  
21Z



H6606  
25Z



H6607  
36Z



H6608  
21Z

Baymat Matbaa Malzemeleri

1



Baymat Matbaa Malzemeleri

2



Baymat Matbaa Malzemeleri

3



Baymat Matbaa Malzemeleri

4



Baymat Matbaa Malzemeleri

5



Baymat Matbaa Malzemeleri

6

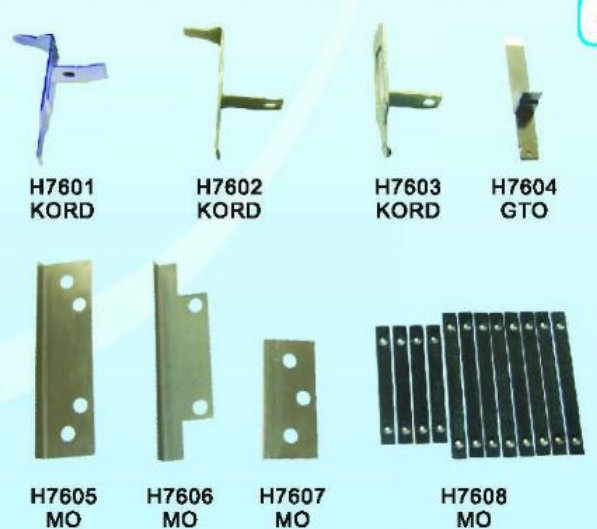

Baymat Matbaa Malzemeleri

1



Baymat Matbaa Malzemeleri

2

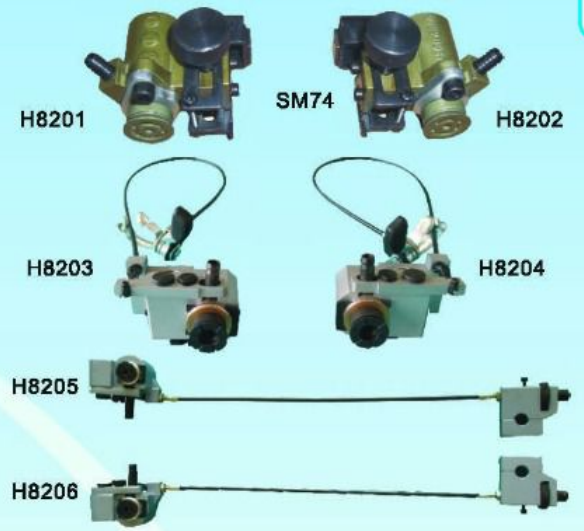

Baymat Matbaa Malzemeleri

3

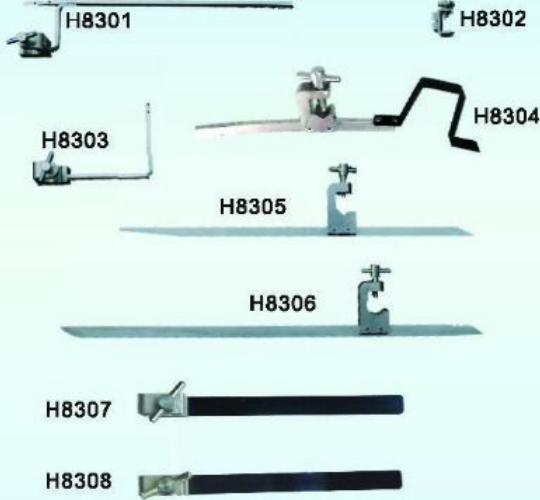

Baymat Matbaa Malzemeleri

4



Baymat Matbaa Malzemeleri

5

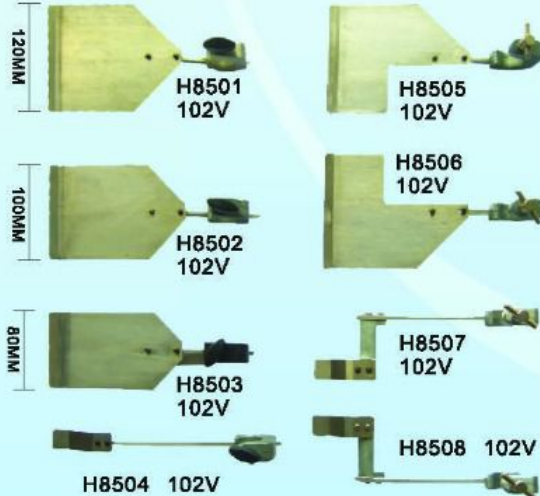

Baymat Matbaa Malzemeleri

6





Baymat Matbaa Malzemeleri

1



H9101  
KORD



H9102  
GTO

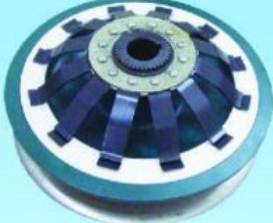

H9103  
KORD



H9104  
KORD

Baymat Matbaa Malzemeleri

2



H9201  
GTO



H9202  
GTO



H9203  
GTO



H9204  
GTO46/GTO52

Baymat Matbaa Malzemeleri

3



H9301  
GTO/400J 24R  
460J 12R

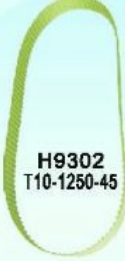

H9302  
T10-1250-45



28x900  
GTO



H9303

12PL 4622  
12PL 3696  
12PL 3327  
20PL 2362  
19PL 4470  
15PL 1715



47x1650  
47x1750  
47x1850  
47x1950

H9305  
KORD

H9304

Baymat Matbaa Malzemeleri

4



H9401  
SM74



H9402  
GTO/MO



H9403  
102



H9404  
GTO



H9405  
CD102



H9406  
SM74



H9407  
SM74



H9408  
SM74



T5-390-8

H9409

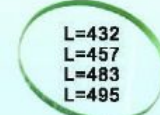

L=432  
L=457  
L=483  
L=495

H9410



H9411

Baymat Matbaa Malzemeleri

5

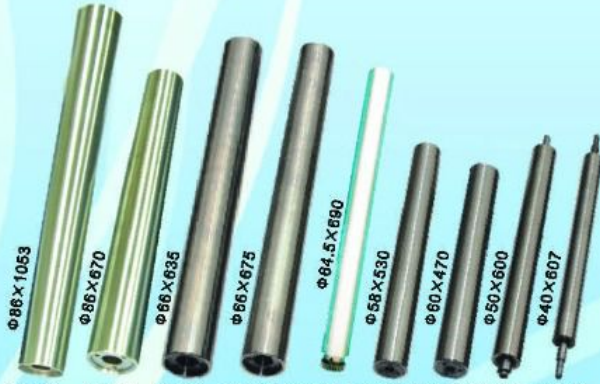

H9501 102V  
H9502 SOR  
H9503 KORD62  
H9504 KORD64  
H9505 MO  
H9506 GTO52  
H9507 GTO48  
H9508 GTO52  
H9509 GTO48

Baymat Matbaa Malzemeleri

6



H9601 102V  
H9602 102V  
H9603 SORD  
H9604 102V  
H9605 102V  
H9606 102V  
H9607 MO  
H9608 102V  
H9609 SORD

Baymat Matbaaa Malzemeleri

**1**

H10101 SM102 T=12  
H10102 SM102 T=14  
H10103 SM102  
H10104 SM74/MO

H10105 CD102  
H10106 102V 102F  
H10107 MOV  
H10108 SM52  
H10109 SM74 PM74  
H10110 MOV  
H10111 102V

44Z 44Z 38Z 38Z 38Z 44Z

**2**

H10201 102V  
H10202 102V  
H10203 KORD  
H10204 KORD  
H10205 D=53

102V 102V SM74

H10206 H10207 H10208 H10209 H10210 H10211

H10212 102F  
H10213 102V  
H10214 SM74

Baymat Matbaaa Malzemeleri

**3**

H10301 H10302 H10303 H10304 H10305 H10306 H10307

102/SOR L=313 L=360 L=370

**4**

H10401 H10402 H10403 H10404 H10405 H10406

MO 102V MO 102V 102V

Baymat Matbaaa Malzemeleri

**5**

H10501 102V  
H10502 102V  
H10503 CD102  
H10504 MO  
H10505 MO

CD102 102/SOR

H10506 HD10507 H10508 H10509

H10510 H10511 H10512 H10513

**6**

H10601 102V  
H10602  
H10603 CD102  
H10604  
H10605 6+1  
H10606

H10607 H10608 H10609 H10610 H10611

H10612 H10613 H10614 H10615

Baymat Matbaa Malzemeleri

1



Baymat Matbaa Malzemeleri

2

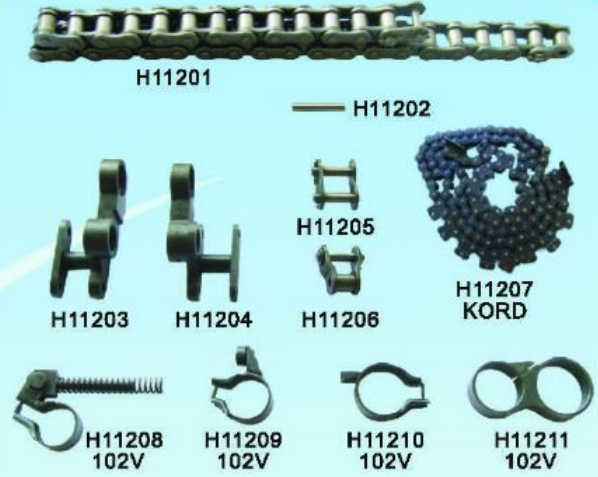

Baymat Matbaa Malzemeleri

3



Baymat Matbaa Malzemeleri

4



Baymat Matbaa Malzemeleri

5

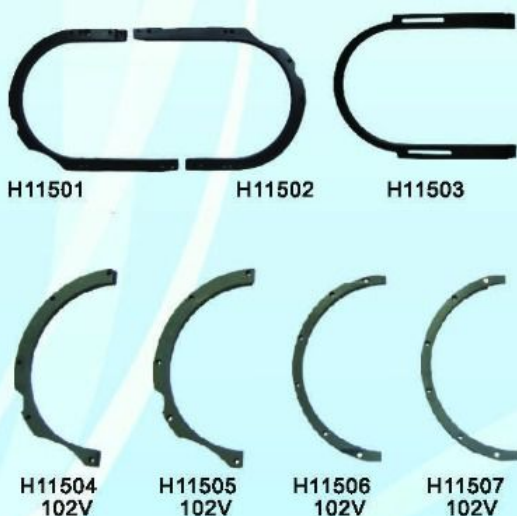

Baymat Matbaa Malzemeleri

6



Baymat Matbaa Malzemeleri

1



Baymat Matbaa Malzemeleri

2



Baymat Matbaa Malzemeleri

3



Baymat Matbaa Malzemeleri

4



Baymat Matbaa Malzemeleri

5



Baymat Matbaa Malzemeleri

6



Baymat Matbaa Malzemeleri

1



Baymat Matbaa Malzemeleri

2



Baymat Matbaa Malzemeleri

3



Baymat Matbaa Malzemeleri

4



Baymat Matbaa Malzemeleri

5



Baymat Matbaa Malzemeleri

6



Baymat Matbaa Malzemeleri

1

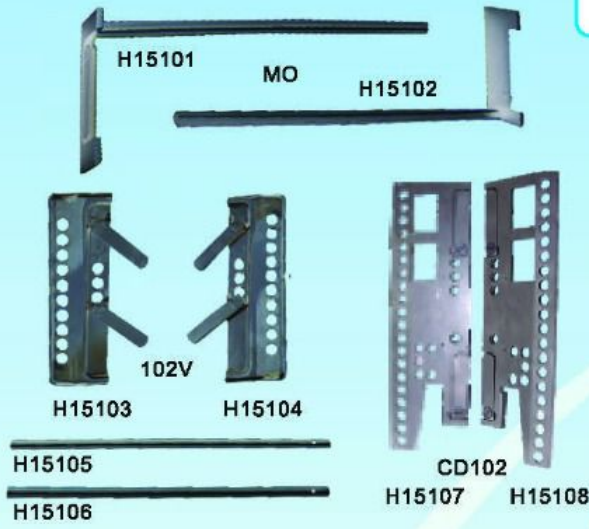

Baymat Matbaa Malzemeleri

2



Baymat Matbaa Malzemeleri

3



Baymat Matbaa Malzemeleri

4



Baymat Matbaa Malzemeleri

5



Baymat Matbaa Malzemeleri

6



### Baymat Matbaa Malzemeleri

1

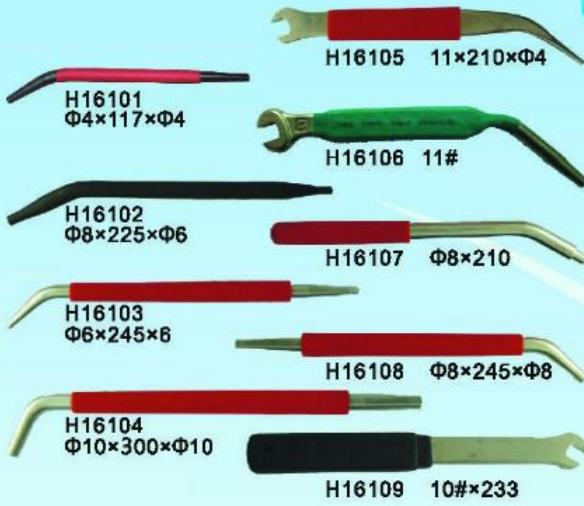

### Baymat Matbaa Malzemeleri

2



### Baymat Matbaa Malzemeleri

3



### Baymat Matbaa Malzemeleri

4



### Baymat Matbaa Malzemeleri

5



### Baymat Matbaa Malzemeleri

6



Baymat Matbaa Malzemeleri

1



H17101	GTO46	H17106	KORD64
H17102	GTO52	H17107	KORS
H17103	MO	H17108	SM102
H17104	SM74	H17109	SM52
H17105	KORD62	H17110	QM46

Baymat Matbaa Malzemeleri

2

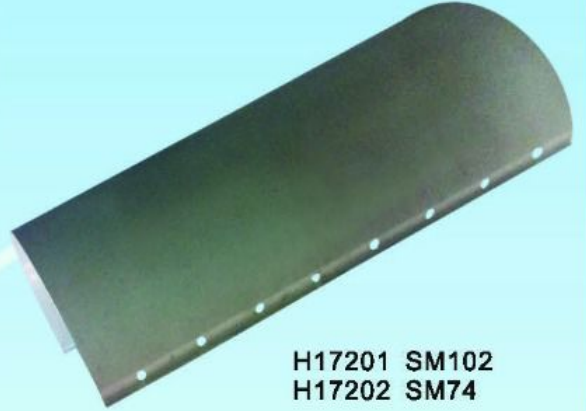

H17201 SM102  
H17202 SM74

Baymat Matbaa Malzemeleri

3



H17301	H17306	L=200
H17302	H17307	L=118
H17303	H17308	
H17304	H17309	

Baymat Matbaa Malzemeleri

4



H17401	H17402	H17403
H17404	H17405	H17406
H17407	H17408	

Baymat Matbaa Malzemeleri

5



H17501	H17502	H17503
H17504	H17505	H17506
H17507	H17508	H17509
H17510		

Baymat Matbaa Malzemeleri

6



H17601	H17602	0.8x 0.8x20
1x20 1x25 1.2x25 1.5x25 1x28 1.2x28 1.5x28	H17603	H17604
1x25 1x28	H17605	H17606



## Baymat Matbaa Malzemeleri

1



## Baymat Matbaa Malzemeleri

2



## Baymat Matbaa Malzemeleri

3



## Baymat Matbaa Malzemeleri

4



## Baymat Matbaa Malzemeleri

5



## Baymat Matbaa Malzemeleri

6

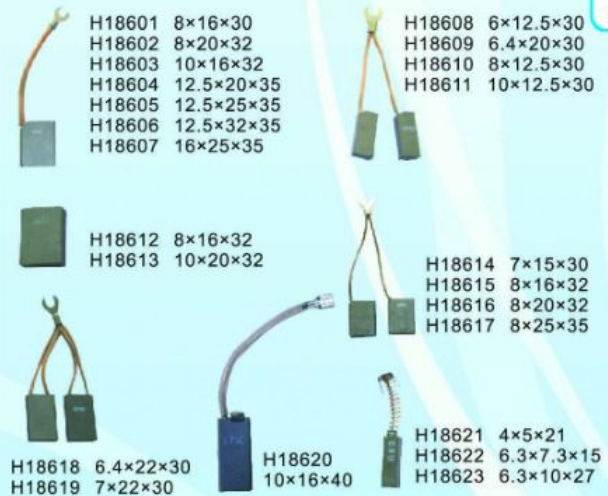

Baymat Matbaa Malzemeleri

1



R1101  
R-600

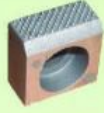

R1102  
RVK3B/FOB



R1103  
RVK3B/FOB



R1104  
R-600



R1105  
RVK3B/FOB

Baymat Matbaa Malzemeleri

2

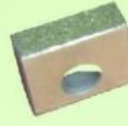

R1201  
R-700

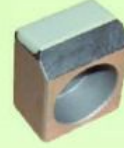

R1202  
R-800



R1203  
R-800



R1204  
R-700



R1205  
R-700



R1206  
R-800

Baymat Matbaa Malzemeleri

3

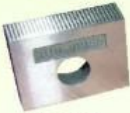

R1301  
R-800(0998)



R1302  
R-800(0998)

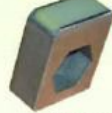

R1303



R1304  
R-800(2156)



R1305  
R-800(2156)



R1306  
R-700 L=95

Baymat Matbaa Malzemeleri

4

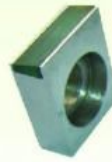

R1401

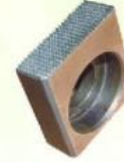

R1402

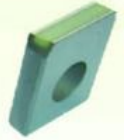

R1403  
R-700



R1404  
R2+2



R1405  
R2+2



R1406  
R-600

Baymat Matbaa Malzemeleri

5



R1501  
R-600



R1502  
R-600



R1503  
R-600



R1504  
R-600



R1505



R1506



R1509  
RVK3B



R1510  
RVK3B



R1511  
R-800



R1512  
R-800



R1513  
R-700



R1514  
R-700

Baymat Matbaa Malzemeleri

6



R1601  
FOB



R1602



R1603



R1604



R1605  
R-900



R1606  
R-700



R1607



R1608



R1609  
FOB



R1610  
RVK3B



R1611  
RVK3B



R1612  
RVK3B

Baymat Matbaa Malzemeleri

1



Baymat Matbaa Malzemeleri

2



Baymat Matbaa Malzemeleri

3



Baymat Matbaa Malzemeleri

4



Baymat Matbaa Malzemeleri

5



Baymat Matbaa Malzemeleri

6



Baymat Matbaa Malzemeleri

1



Baymat Matbaa Malzemeleri

2



Baymat Matbaa Malzemeleri

3

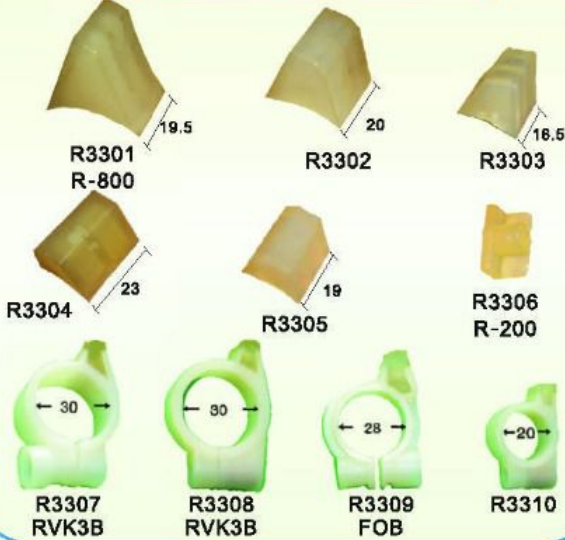

Baymat Matbaa Malzemeleri

4



Baymat Matbaa Malzemeleri

5



Baymat Matbaa Malzemeleri

6



Baymat Matbaa Malzemeleri

1



R4101 R4102 R4103 R4104



R4105 R4106 R4107 R4108

Baymat Matbaa Malzemeleri

2



R4201 R4202 R4203 R4204 R4205 R4206



R4207 R4208 R4209 R4210



R4211 R4212 R4213 R4214 R4215 R4216

Baymat Matbaa Malzemeleri

3



R4301 R4302 R4303 R4304



R4305 R4306



R4307 R4308 R4309



R4310 R4311 R4312 R4313

Baymat Matbaa Malzemeleri

4



R4401 R4402



R4403 R4404 R4405



R4406 R4408 R4410



R4407 R4409 R4411

Baymat Matbaa Malzemeleri

5



R4501 R4502 R4503 R4504 R4505



R4506 R4507



R4508 R4509 R4510 R4511 R4512

Baymat Matbaa Malzemeleri

6



R4601 R4602 R4603 R4604 R4605 RVK3B



R4606 R4607 R4608 R4609 R4610

Baymat Matbaa Malzemeleri

1



Baymat Matbaa Malzemeleri

2

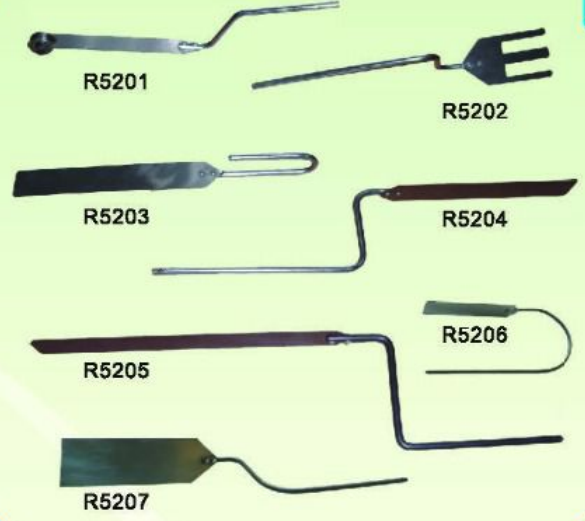

Baymat Matbaa Malzemeleri

3



Baymat Matbaa Malzemeleri

4



Baymat Matbaa Malzemeleri

5



Baymat Matbaa Malzemeleri

6



Baymat Matbaa Malzemeleri

1



R6101 R-800  
R6102 R-600  
R6103  $\Phi$ 45  
R6104  $\Phi$ 40



R6105  $\Phi$ 50  
R6106  $\Phi$ 40  
R6107  $\Phi$ 35  
R6108  $\Phi$ 26  
R6109  $\Phi$ 20

Baymat Matbaa Malzemeleri

2



R6201 R-700  
R6202 R-700  
R6203 R-700



R6204 RK700S  
R6205 RK702S  
R6206 RK33F



R6207 RK770S  
R6208 RK10S  
R6209 R-700

Baymat Matbaa Malzemeleri

3



R6301 R6302 R6303 R6304



R6305  
R6306  
R6307  
R6308

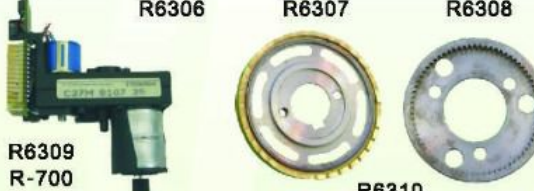

R6309 R-700 R-300  
R6310 RVK3B

Baymat Matbaa Malzemeleri

4



R6401  
R6402 R-700  
R6403 R6404



R6405 R-700  
R6406  
R6407  
R6408  
R6409  
R6410  
R6411  
R6412  
R6413 R-700  
R6414 R-700

Baymat Matbaa Malzemeleri

5



R6501 38Z  
R6502 18Z  
R6503 30Z



R6504 31Z  
R6505 25Z  
R6506 25Z

Baymat Matbaa Malzemeleri

6



R6601 内孔20  
R6602 18Z  
R6603 24Z



R6604 内孔40X40  
R6605 21Z  
R6606 34Z

Baymat Matbaa Malzemeleri

1



Baymat Matbaa Malzemeleri

2

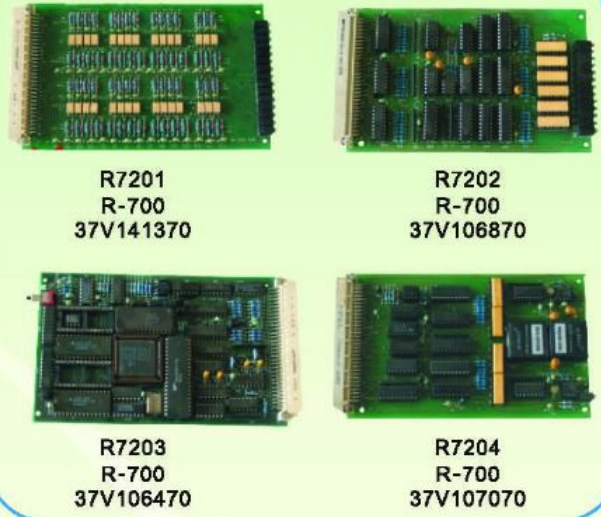

Baymat Matbaa Malzemeleri

3

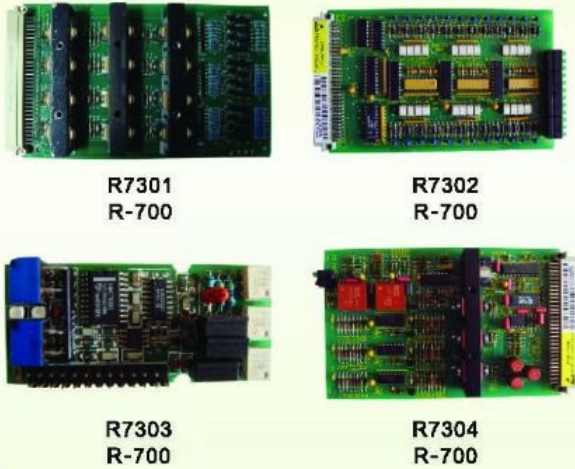

Baymat Matbaa Malzemeleri

4

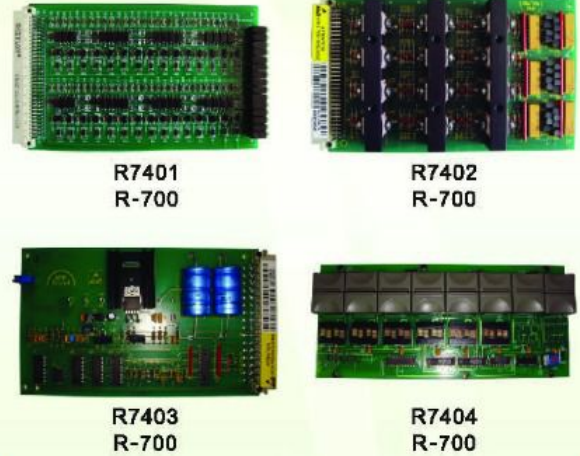

Baymat Matbaa Malzemeleri

5



Baymat Matbaa Malzemeleri

6





Baymat Matbaa Malzemeleri

1

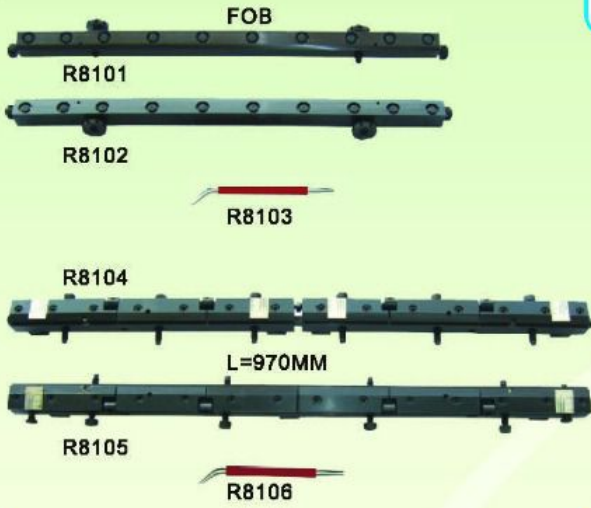

Baymat Matbaa Malzemeleri

2

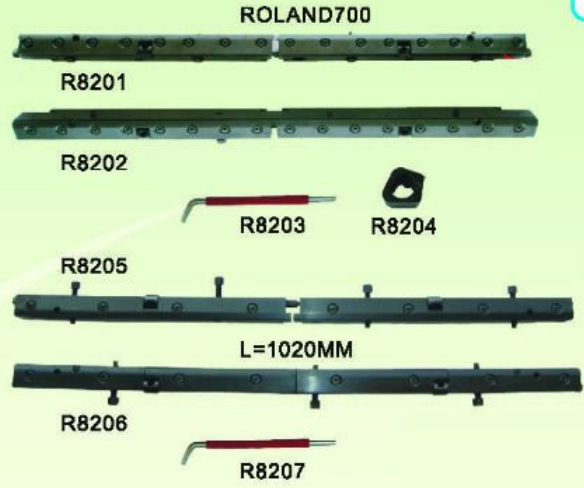

Baymat Matbaa Malzemeleri

3



Baymat Matbaa Malzemeleri

4

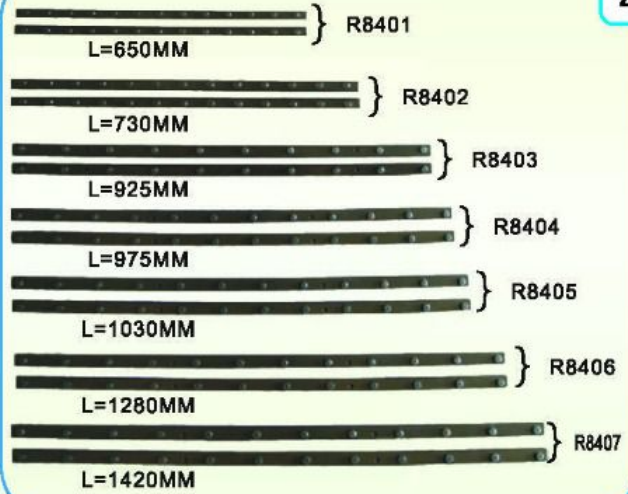

Baymat Matbaa Malzemeleri

5

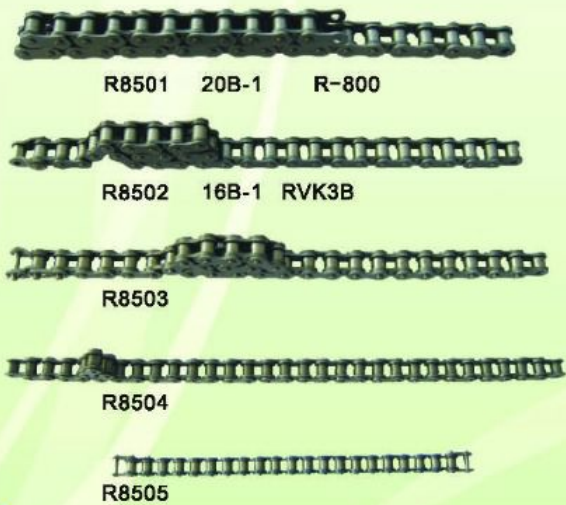

Baymat Matbaa Malzemeleri

6

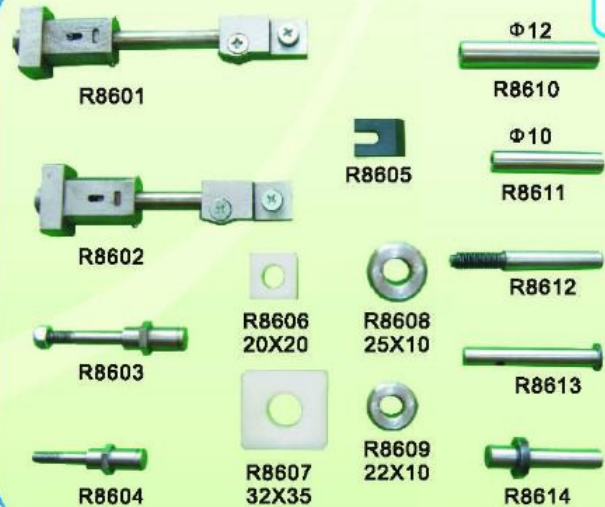

Baymat Matbaa Malzemeleri

1

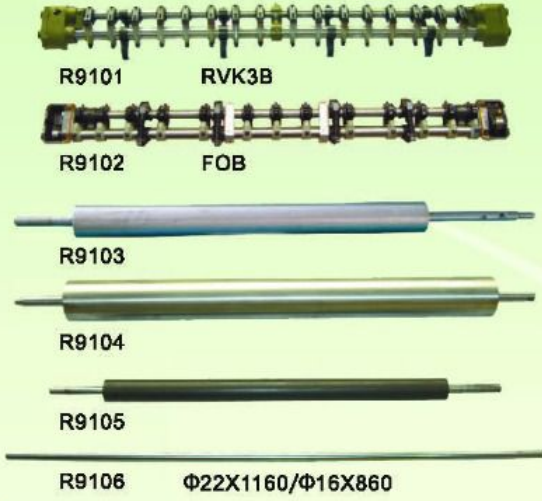

Baymat Matbaa Malzemeleri

2



Baymat Matbaa Malzemeleri

3



Baymat Matbaa Malzemeleri

4

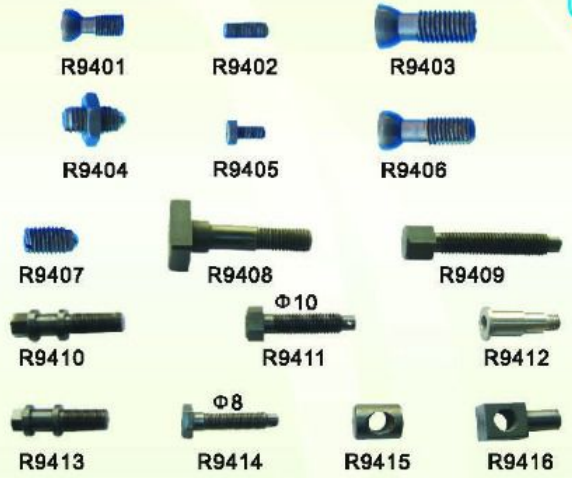

Baymat Matbaa Malzemeleri

5



Baymat Matbaa Malzemeleri

6



Baymat Matbaa Malzemeleri

1

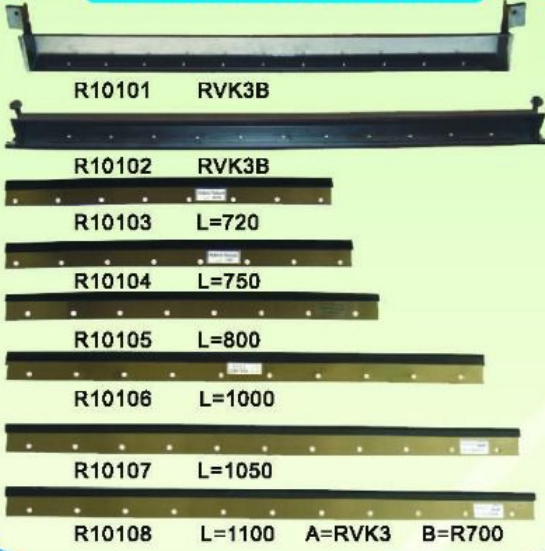

Baymat Matbaa Malzemeleri

2

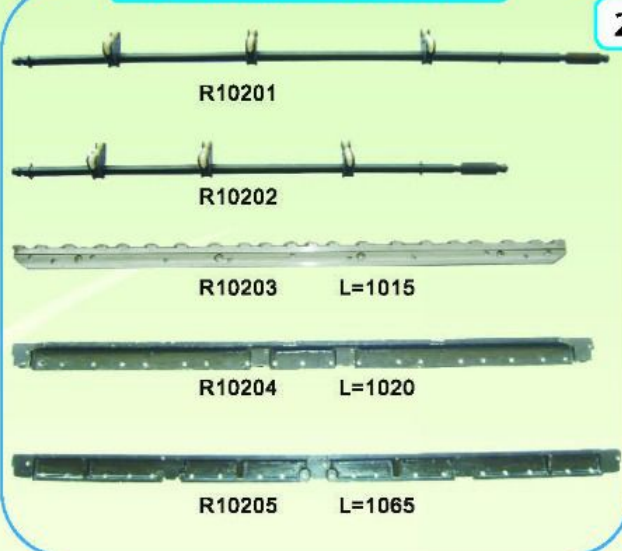

Baymat Matbaa Malzemeleri

3

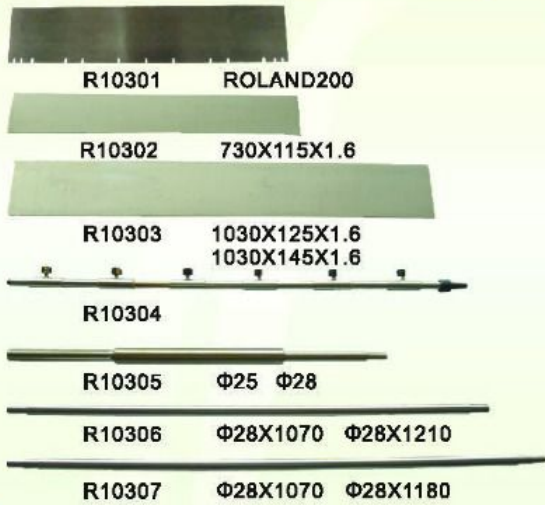

Baymat Matbaa Malzemeleri

4



Baymat Matbaa Malzemeleri

5



Baymat Matbaa Malzemeleri

6



Baymat Matbaa Malzemeleri

1

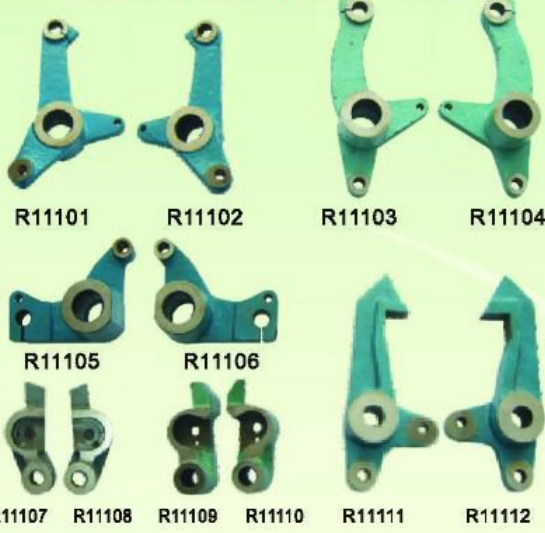

Baymat Matbaa Malzemeleri

2



Baymat Matbaa Malzemeleri

3



Baymat Matbaa Malzemeleri

4



Baymat Matbaa Malzemeleri

5



Baymat Matbaa Malzemeleri

6



Baymat Matbaa Malzemeleri

1

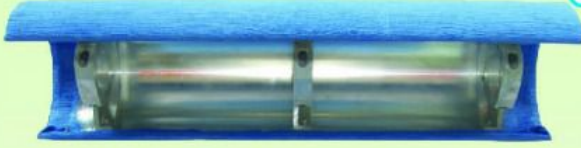

R12101 RVK3B L=1000 RVP2C L=910



R12102 RZ FOB L=700

Baymat Matbaa Malzemeleri

2



R12201  
Φ60



R12202  
Φ80



R12203  
Φ95



R12204  
Φ50

Baymat Matbaa Malzemeleri

3



R12301  
19Z



R12302  
25Z Φ20



R12303  
25Z Φ25



R12304  
24Z



R12305  
24Z



R12306  
26Z



R12307  
20Z



R12308  
33Z



R12309  
33Z

Baymat Matbaa Malzemeleri

4



R12401



R12402  
14Z



R12403



R12404  
19Z



R12405  
14Z



R12406  
22Z



R12407  
25Z



R12408  
57Z

Baymat Matbaa Malzemeleri

5



R12501  
Φ180XΦ145XΦ116  
Φ170XΦ160XΦ117



R12502  
Φ160XΦ145XΦ102



R12503  
Φ120XΦ110XΦ82



R12504  
Φ115XΦ100XΦ110



R12505  
Φ130XΦ120XΦ99  
Φ130XΦ120XΦ82



R12506  
Φ120XΦ140XΦ13

Baymat Matbaa Malzemeleri

6



R12601



R12602



R12603



R12604



R12605



R12606



R12607



R12608



R12609



R12610



R12611



R12612  
R-700

Baymat Matbaa Malzemeleri

1



Baymat Matbaa Malzemeleri

2



Baymat Matbaa Malzemeleri

3



Baymat Matbaa Malzemeleri

4



Baymat Matbaa Malzemeleri

5



Baymat Matbaa Malzemeleri

6



Baymat Matbaa Malzemeleri

1

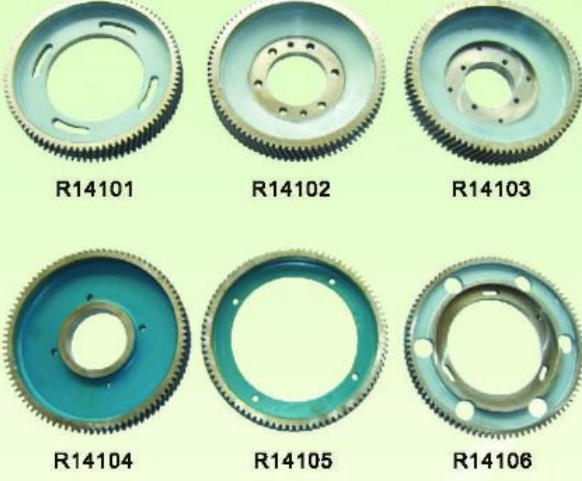

Baymat Matbaa Malzemeleri

2



Baymat Matbaa Malzemeleri

3



Baymat Matbaa Malzemeleri

4



Baymat Matbaa Malzemeleri

5



Baymat Matbaa Malzemeleri

6



Baymat Matbaa Malzemeleri

1



Baymat Matbaa Malzemeleri

2

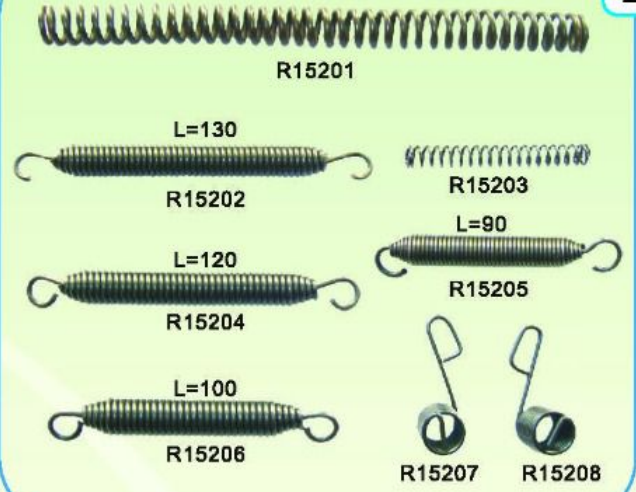

Baymat Matbaa Malzemeleri

3



Baymat Matbaa Malzemeleri

4



Baymat Matbaa Malzemeleri

5



Baymat Matbaa Malzemeleri

6





## Heidelberg , Roland Lastik Memeleri



N	M	C	OD	ID	T
RS01	Naturalrubber	Blue	38MM	13MM	1MM
RS02	Naturalrubber	Grey	38MM	13MM	0.8MM
RS03	Naturalrubber	Orange	38MM	13MM	0.5MM
RS04	Naturalrubber	Grey	32MM	13MM	0.8MM
RS05	Naturalrubber	Grey	30MM	13MM	0.8MM
RS06	Naturalrubber	Natural	21MM	7.5MM	0.8MM
RS07	Naturalrubber	Natural	21MM	7.5MM	0.5MM
RS08	Naturalrubber	Red	26MM	6MM	2MM
RS09	Naturalrubber	White	22MM	3MM	2MM

### FOR RYOBI

N	C	OD	ID	H
RS10	Natural	16MM	4MM	4.5MM



### FOR MITSUBISHI

N	C	OD	ID	H
RS11	Black	27MM	7.5MM	8MM



N	C	OD	ID	H
RS12	Red	22MM	7MM	15MM



### FOR AB-DICK

N	C	OD	ID	H
RS13	Natural	19MM	7MM	7MM



### FOR MULLER MARTINI

N	C	OD	ID	H
RS14	Red	12MM	6MM	8MM



N	C	OD	ID	H
RS15	Red	21MM	6MM	15MM



N	C	OD	ID	H
RS16	Black	21MM	6MM	15MM



N	C	OD	ID	H
RS17	Green	25MM	6MM	14.5MM



N	C	OD	ID	H
RS18	Black	25MM	6MM	14.5MM





N	M	C	OD	ID	T
RS19	Silicon	Red	38MM	13MM	1MM
RS20	Silicon	Red	38MM	13MM	0.8MM
RS21	Silicon	Red	38MM	13MM	0.5MM
RS22	Silicon	Red	32MM	13MM	1MM
RS23	Silicon	Red	32MM	13MM	0.8MM
RS24	Silicon	Red	32MM	13MM	0.5MM
RS25	"per"synthetic	Clear	38MM	13MM	1MM
RS26	"per"synthetic	Clear	32MM	13MM	0.5MM
RS27	"per"synthetic	Clear	30MM	13MM	0.8MM
RS28	"per"synthetic	Yellow	24MM	10MM	0.8MM
RS29	Natural Rubber	Grey	38MM	13MM	1MM
RS30	Natural Rubber	Grey	30MM	13MM	0.8MM

N	C	OD	ID	H
RS31	Gray	27MM	7MM	6MM

N	C	OD	ID	H
RS34	Red	19MM	7MM	3MM

N	C	OD	ID	H
RS32	Black	16.5MM	7MM	7MM

N	C	OD	ID	H
RS35	Black	15.5MM	4MM	16.5MM

N	C	OD	ID	H
RS33	Black	28MM	17MM	6MM

N	C	OD	ID	H
RS36	Black	30.5MM	5.5MM	12MM



## ROLAND

N	M	C	OD	ID	T
RS37	Natural Rubber	Blue	38MM	15MM	1MM
RS38	Natural Rubber	Blue	38MM	15MM	0.7MM
RS39	Natural Rubber	Blue	35MM	15MM	1MM
RS40	Natural Rubber	Blue	35MM	15MM	0.7MM
RS41	Natural Rubber	Blue	32MM	15MM	1MM
RS42	Natural Rubber	Blue	32MM	15MM	0.7MM

N	C	OD	ID	H
RS43	Brown	30.5MM	15.5MM	15.5MM

## HAMADA

N	C	OD	ID	H
RS44	Beige	20MM	6MM	9MM

N	C	OD	ID	H
RS45	Brown	18MM	4MM	17MM

N	C	OD	ID	H
RS46	Clear	24MM	6MM	17MM

N	C	OD	ID	H
RS47	Natural	21MM	7.5MM	0.8MM
RS48	Natural	21MM	7.5MM	0.5MM



N	C	OD	ID	H
RS49	Grey	16MM	6MM	9.5MM

N	C	OD	ID	H
RS50	Black	16.5MM	12MM	36MM

## 2.EL MATBAA MAKİNE KOMPRESÖRLERİ

