

MAKİNE KATALOĐU

TEKNOLOJİDE
ÇÖZÜM ORTAĐINIZ



ORMEND
MAKINA SAN. TİC. LTD. ŞTİ.

ORMEND MAKİNE

TEKNOLOJİDE ÇÖZÜM ORTAĞINIZ

Ahşap işleme makinaları, kesici takımlar, yedek parça ve teknik servis konularında iş ortaklarımızın daima yanında olmak ve teknolojideki son yenilikleri sizlerle buluşturmak hedefindeyiz.

20 yılı aşkın tecrübemiz, konusunda uzman kadromuzun bilgi ve donanımı ile birlikte siz değerli iş ortaklarımızın ihtiyaçlarına en uygun çözümler üretmek en temel ilkemizdir.

ORMEND ailesi olarak biz, ahşap işleme makinaları ve kesici takım üreten dünyadaki en değerli markaların mümessilliğini yapmanın gururunu yaşamamızın yanında, kendimizi iş ortaklarımıza layık olabilmek adına sürekli geliştirmekteyiz. Ürün satışının dışında, satış sonrasında sizler için ne derece önemli olduğunu bilincindeyiz. Bundan dolayı teknik servis ve yedek parça konularında sizlere en hızlı hizmeti sağlamak için çalışıyoruz.

Saygılarımızla,

ORMEND MACHINE,

YOUR SOLUTION PARTNER IN TECHNOLOGY

We aim to always be with our business partners in wood processing machines, cutting tools, spare parts and technical service and bring you the latest innovations in technology.

Our basic principle is to produce the most suitable solutions for the needs of our valued business partners, with our experience of more than 20 years and the knowledge and equipment of our expert staff.

As the Ormend Family, we are proud to represent the most valuable brands in the world that produce wood processing machines and cutting tools and we are constantly improving to be worthy to our business partners. Apart from product sales, we are aware of how important after sales is for you, so we are working to provide you with the fastest service in technical service and spare parts.

Regards



C41C - C30C
Universal Kombine Makine
Universal Combined Machine



TS 35ES
Kombine Çizicili Yatar Daire Makinesi
Spindle Moulder and Circular Saw Combination Machine



PFS 52ES - PFS 41ES - PFS 30 - PFS 41
Kombine Planya Makinesi
Combination Machines Surface Thickness/Planer



PF 41ES
Planya Makinesi
Surface Planer



PS 41ES
Kalınlık Makinesi
Thickening Planer



SC 40P - SC 30P
Çizicili Yatar Daire Makinesi
Circular Saw



SC 30 - SC 20
Çizicili Yatar Daire Makinesi
Circular Saw



F 205 - F 200 - F 105
Freze Makinesi
Spindle Moulder



LN
Palet Zımpara
Stroke Sanders



R 800 - R 600
Şaküllü Freze Makinesi
Milling Machine



FM 21
Çoklu Delik Makinesi
Boring Machine



FLEXA 17 - ALA 20 PLUS - ALA 205
Kenar Bantlama Makinesi
Automatic Edgebanders



PF 52 - PF 41
Planya Makinesi
Surface Planer



PS 63 - PS 52
Kalınlık Makinesi
Thickening planer



XENIA 30
Çizicili Yatar Daire Makinesi
Circular Saw



XENIA 40
Çizicili Yatar Daire Makinesi
Circular Saw



F 23
Freze Makinesi
Spindle Moulder



F 25
Açılı Freze Makinesi +45
Spindle Moulder With Fixed and Tilting



PF 520 - PF 410
Planya Makinesi
Surface Planer



PS 630 - PS 520
Kalınlık Makinesi
Thickening planer



PFS 520
Kombine Planya Makinesi
Combination Machines Surface Thickness / Planer



AURA
Şerit Testere Makinesi
Band Saw



F 255
Açılı Freze Makinesi +45
Spindle Moulder With Fixed and Tilting



XENIA 60 - XENIA 70
Çizicili Yatar Daire Makinesi
Circular Saw



LIBRA 10 - 35
Kalibre ve Hassas Zımpara Makinesi
Automatic Wide Belt Sanders



LIBRA 45
Kalibre ve Hassas Zımpara Makinesi
Automatic Wide Belt Sanders



LIBRA 55 - 65
Kalibre ve Hassas Zımpara Makinesi
Automatic Wide Belt Sanders



FLEXA 27
Otomatik Tek Taraflı Kenar Bantlama Makinesi
Automatic Edge Banding Machine



FLEXA 47
Otomatik Tek Taraflı Kenar Bantlama Makinesi
Automatic Edge Banding Machine



FLEXA 507
Endüstriyel Tek Taraflı Kenar Bantlama Makinesi
Industrial Edge Banding Machine



FLEXA 607
Endüstriyel Tek Taraflı Kenar Bantlama Makinesi
Industrial Edge Banding Machine



AXO 200
Panel Ebatlama Makinesi
Automatic Panel Saws



AXO 300
Panel Ebatlama Makinesi
Automatic Panel Saws



AXO 400 T
Asansörlü Panel Ebatlama Makinesi
Automatic Panel Saws With Lifting Table



AXO 500 T HD
Asansörlü Panel Ebatlama Makinesi
Automatic Panel Saws With Lifting Table



MATRIX 230X
Otomatik Profil Freze Makinesi
Automatic Moulders



EASY JET
Düz Tabla CNC İşleme Merkezi
CNC Working Center - Nesting



JET SMART
CNC Kontrollü Delik ve Freze Makinesi
Automatic Boring And Grooving Center



JET MASTER T
CNC İşleme Merkezi 3-4-5 Eksen
CNC working center - 3-4-5 axes



JET MASTER RT
Düz Tabla CNC İşleme Merkezi 3-4-5 Eksen
CNC Working Center - Nesting- 3-4-5 axes



JET MASTER 30 - 35
CNC İşleme Merkezi 3-4-5 Eksen
CNC working center - 3-4-5 axes



JET ELITE
CNC İşleme Merkezi 3-4 Eksen
CNC working Center - 3-4 axes

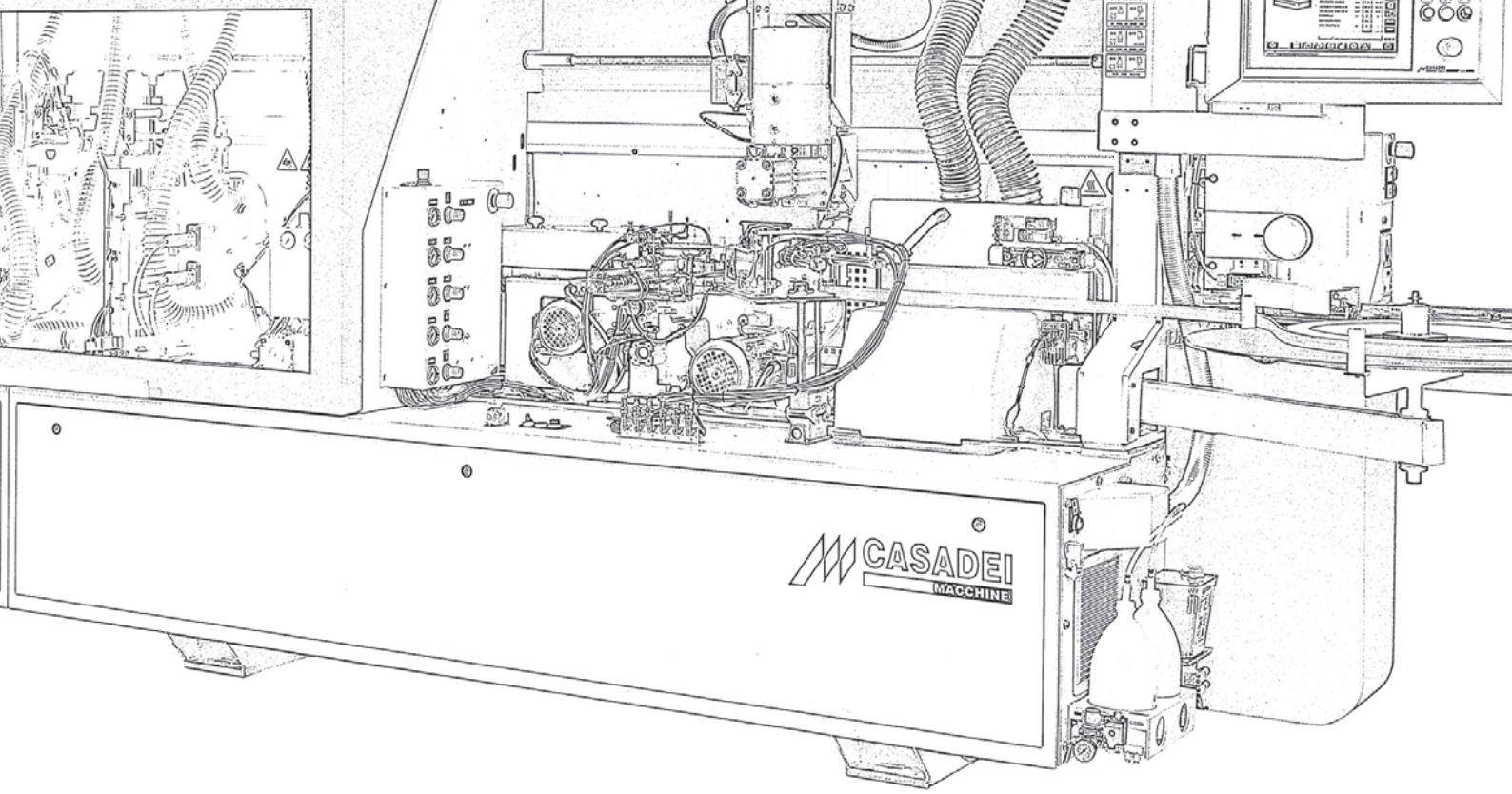

PANEL EBATLAMA MAKİNELERİ



CASADEI

AXO 200

Panel Ebatlama Makinesi

Automatic beam saws

Küçük ve orta ölçekli işletmelere uygun / Suitable for small and medium sized manufactures.
70 mm testere projeksiyonu / 70 mm saw projection.
Yüksek kesim hassasiyeti / High cutting precision.
Kolay testere değişimi / Quick saw change.
Sınıfındaki en başarılı şase tasarımı / The most successful chassis design in its class.
Optimizasyon programı seçenekleri / Optimization program options.



CASADEI

AXO 300

Panel Ebatlama Makinesi

Automatic beam saws

Orta ölçekli işletmelere uygun / Suitable for medium sized manufactures.
90 mm testere projeksiyonu / 90 mm saw projection.
Hassas kesimi garanti eden ağır şase yapısı / Heavy structure that guarantees perfect cutting.
Güçlü motor seçenekleri ile yüksek kapasite / High capacity with powerful engine options.
Kolay testere değişimi / Quick saw change.
Optimizasyon programı seçenekleri / Optimization program options.



CASADEI

AXO 400

Panel Ebatlama Makinesi

Automatic beam saws

Orta ve büyük ölçekli işletmelere uygun / Suitable for medium and large sized manufactures.
110 mm testere projeksiyonu / 110 mm saw projection.

İleri teknoloji / High technology.

Hassas kesimi garanti eden ağır şase yapısı / Heavy structure that quarantees perfect cutting.

Güçlü motor seçenekleri ile yüksek kapasite / High capacity with powerful engine options.

Kolay testere değişimi / Quick saw change.

Optimizasyon programı seçenekleri / Optimization program options.

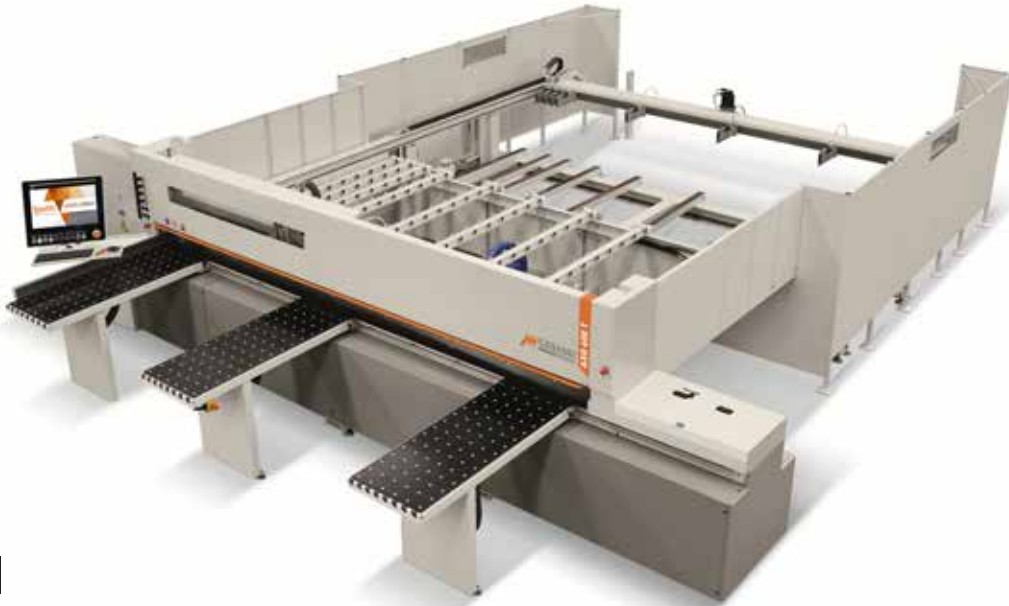

CASADEI

AXO 400 T

Asansörlü Panel Ebatlama Makinesi

Automatic beam saws with lifting table

Orta ve büyük ölçekli işletmelere uygun / Suitable for medium and large sized manufactures.
110 mm testere projeksiyonu / 110 mm saw projection.

Ağır tip asansör sistemi / Heavy duty lift system.

Endüstriyel makine yapısı / Industrial machine structure.

Hassas kesim garantisi / Precision cutting quarantine.

Güçlü motor seçenekleri ile yüksek kapasite / High capacity with powerful engine options.

Kolay testere değişimi / Quick saw change.

Optimizasyon programı seçenekleri / Optimization program options.



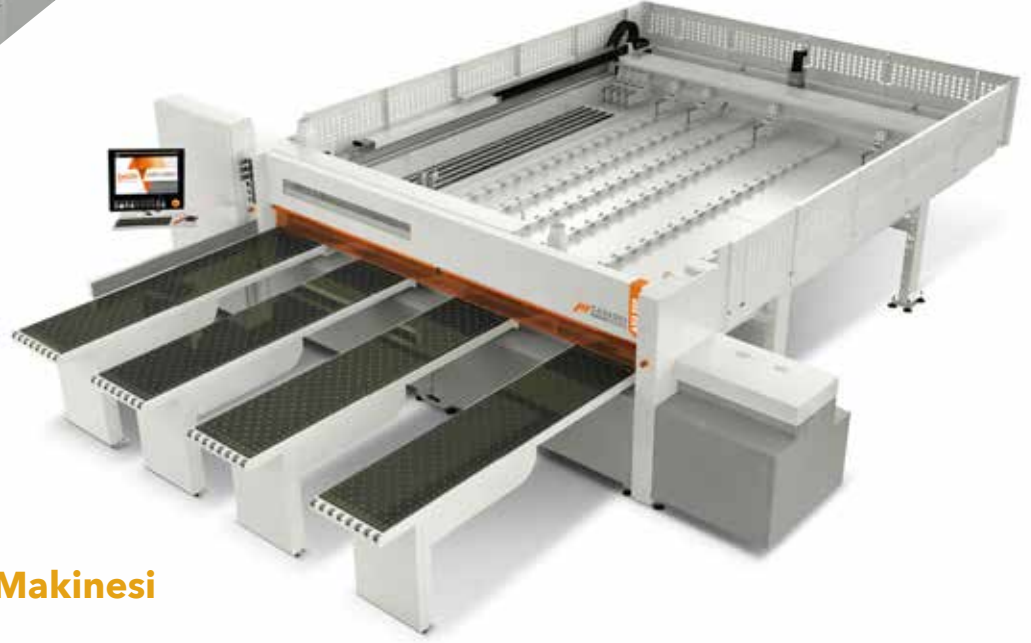

CASADEI AXO 500 HD Panel Ebatlama Makinesi

Automatic beam saws

Orta ve büyük ölçekli işletmelere uygun / Suitable for medium and large sized manufactures.
130 mm testere projeksiyonu / 130 mm saw projection.
Endüstriyel segmentte ağır şase tipi / Industrial segment heavy chassis type.
Yüksek kesim hassasiyeti / High cutting precision.
Alternatif tutucu seçenekleri / Alternative gripper options.
Güçlü motor seçenekleri ile yüksek kapasite / High capacity with powerfull engine options.
Kolay testere değişimi / Quick saw change.
Optimizasyon programı seçenekleri / Optimization program options.

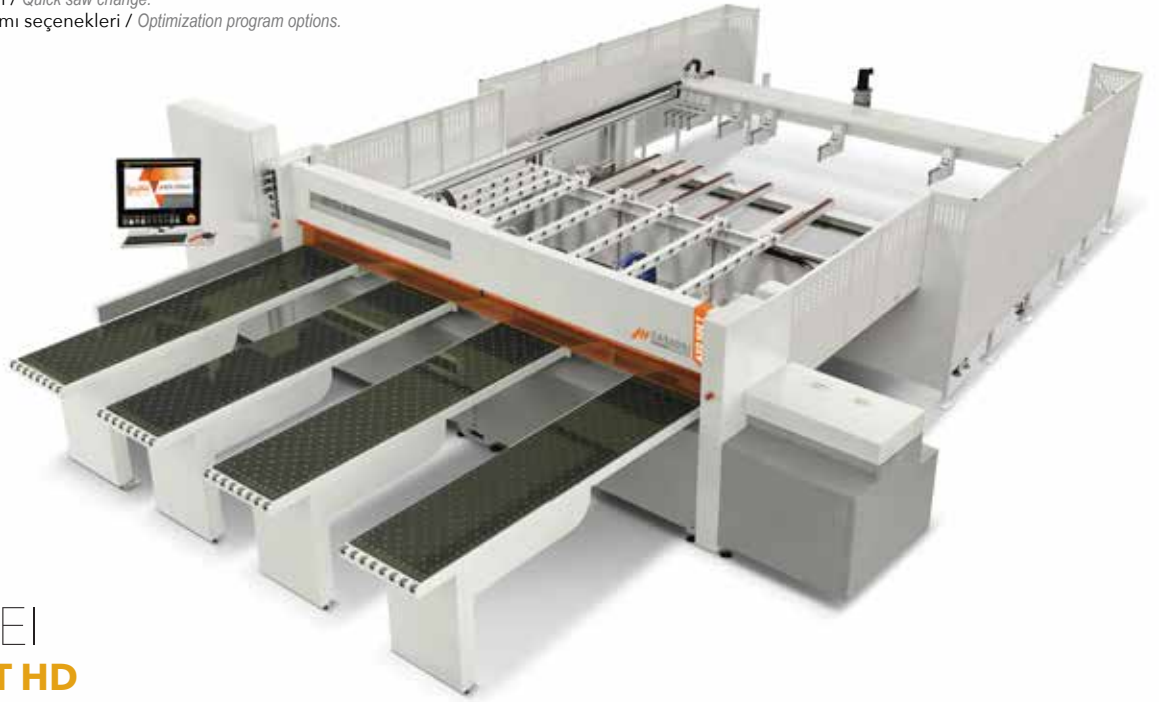

CASADEI AXO 500 T HD Asansörlü Panel Ebatlama Makinesi

Automatic beam saws with lifting table

Büyük ölçekli işletmelere uygun / Suitable for large sized manufactures.
130 mm testere projeksiyonu / 130 mm saw projection.
Endüstriyel segmentte ağır şase tipi / Industrial segment heavy chassis type.
Ağır tip asansör sistemi / Heavy duty lift system.
Yüksek kesim hassasiyeti / High cutting precision.
Alternatif tutucu seçenekleri / Alternative gripper options.
Güçlü motor seçenekleri ile yüksek kapasite / High capacity with powerfull engine options.
Kolay testere değişimi / Quick saw change.
Optimizasyon programı seçenekleri / Optimization program options.

KENAR BANTLAMA MAKİNELERİ



CASADEI

FLEXA 17 Otomatik Tek Taraflı Kenar Bantlama Makinesi

Automatic edge banding machine

FLEXA 17, kaliteden ödün vermeden kullanım kolaylığı isteyen ustalar, küçük ve orta ölçekli işletmeler için ideal çözümdür. / The automatic edge bander FLEXA 17 S is the ideal solution for craftsman and the small to medium industry that requires ease of use without give up quality.

7 m/dak çalışma hızı / 7 m/min working speed.

Küçük makinede ileri teknoloji / Advanced technology in small machine.

Ön freze opsiyonu / Pre-milling option.



CASADEI

FLEXA 27 Otomatik Tek Taraflı Kenar Bantlama Makinesi

Automatic edge banding machine

FLEXA 27, yoğun çalışma koşulları altında bile güvenilirlik ve esneklik arayan ustalar, küçük ve orta ölçekli işletmeler için tasarlanmıştır. / The new edgebander Casadei is conceived for craftsman and small to medium industry looking for reliability and flexibility, even under conditions of intense work.

10 m/dak çalışma hızı / 10 m/min working speed.

Farklı opsiyon seçenekleri / Different options.



CASADEI

FLEXA 47

Otomatik Tek Taraflı Kenar Bantlama Makinesi

Automatic edge banding machine

Yeni kenar bantlama makinesi FLEXA 47, Casadei serisindeki önemli bir yeniliktir. Bu makine maksimum 6 mm kalınlığında masif yapıştırabilir.

Çalışma yüksekliği max 60 mm. XE versiyon seçeneği ile makinede motorize kontrol yapılabilmektedir. / The new edgebander FLEXA 47 is an important novelty in the Casadei range. This machine can apply up to 6 mm solid wood edging on panels with max. thickness 60 mm. Available in version XE with controlled axis.

12-16 m/dak çalışma hızı / 12-16 m/min working speed.

Farklı opsiyon seçenekleri / Different options.



KENAR BANTLAMA MAKİNELERİ



CASADEI

FLEXA 507

Endüstriyel Tek Taraflı Kenar Bantlama Makinesi

Industrial automatic edge banding machine

Otomatik Kenar Bantlama Makinesi Flexa 507, tüm kenar bantlama gereksinimleri için ideal çözümdür. Makine bileşiminin esnekliği, makinayı XE versiyonunda motorize eksen kontrolü imkanı ve yüksek ilerleme hızı Flexa 507'yi son derece çok yönlü bir makine haline getirir. / *The automatic Edge Banding machine Flexa 507 is the ideal solution for all edge banding requirements. The flexibility of the machine composition, the possibility to equip the machine with controlled axis in XE version and the high feed speed make the Flexa 507 an extremely versatile machine.*

Orta ve büyük ölçekli firmalar için endüstriyel şase yapısı / *Industrial chassis structure for medium and large sized manufactures.*

18 m/dak çalışma hızı / *18 m/min working speed.*

Farklı opsiyon seçenekleri / *Different options.*



CASADEI

FLEXA 607

Endüstriyel Tek Taraflı Kenar Bantlama Makinesi

Industrial automatic edge banding machine

Flexa 607, kendi kategorisindeki en üstün özelliklere sahip yüksek performanslı son derece çok yönlü bir makinedir. / *The Edge Banding machine Flexa 607 is an extremely versatile machine with high level performances that place it at the top of its category.*

Büyük ölçekli firmalar için endüstriyel şase yapısı / *Industrial chassis structure for large sized manufactures.*

V üst baskı kayış opsiyonu / *V top press belt option.*

XE versiyonu ile motorize kontrol / *Motorized control with XE version.*

22 m/dak çalışma hızı / *22 m/min working speed.*

Farklı opsiyon seçenekleri / *Different options.*





BUSELLATO CNC kontrollü Delik ve Freze Makinesi

Automatic boring and grooving center

Otomatik delme makinesi Jet Smart, küçük ve orta ölçekli işletmeler için ideal çözüm / *The automatic drilling machine Jet Smart is the ideal solution for craftsmen and small and medium enterprises.*
Esneklik, hız ve kullanım kolaylığı / *Flexibility, speed and ease of use.*
Her türlü çalışma koşulunda yüksek verimlilik / *High efficiency in all working conditions.*
"0"ayar süresi / *"0" setting time.*
Mükemmel hassasiyette delme ve frezeleme / *Drilling and milling with excellent precision.*
Opsiyonel freze motor / *Optional spindle motor.*



BUSELLATO EASY JET Düz Tabla CNC İşleme Makinesi

CNC working center - Nesting

EASY JET, BUSELLATO uzmanlığı ile kolay ve sezgisel kullanım için tasarlanmıştır.

Uygun bir fiyat ile üst düzey yüksek makine performansını korur. / *The EASY JET working centers have been designed for easy and intuitive use by specialized technicians and craftsmen, which maintains the high performance of the larger models whilst being economical.*

Üç taraftan erişilebilen kompakt CNC işleme merkezi. / *It is a compact working center, accessible from three sides.*

Nesting, frezeleme, ebatlama ve delik delme işlemleri yapabilmektedir. / *It can perform nesting, milling, sizing and drilling operations.*

İşletmelerin ihtiyacına uygun çalışma ölçüleri ve opsiyon seçenekleri.

YENİ otomatik yükleme ve boşaltma sistemi, "Cella Nesting" / *Now available with automatic loading and unloading system "Cella Nesting".*



CNC VE CNC DELİK MAKİNELERİ



BUSELLATO

JET ELITE

CNC İşleme Merkezi 3-4 Eksen

CNC working Center 3-4 axes

Endüstriyel yapıda işinin uzmanı / Industrial structure wood processing specialist.
Orta ve büyük işletmeler için mükemmel çözüm ortağı / Perfect solution partner for medium and large sized manufactures.
Farklı motor, delik grubu ve freze seçenekleri / Different motor, drilling and milling options.
3 - 4 Eksen opsiyonları / 3-4 Axis options.
Kolay kurulum ve kompakt tasarım / Easy installation and compact design



BUSELLATO

JET MASTER T

CNC İşleme Merkezi 3-4-5 Eksen

CNC working center - 3-4-5 axes

Uzun yıllara dayanan BUSELLATO uzmanlığı / Long years of BUSELLATO expertise.
Farklı üretim ihtiyaçlarına uygun çözümler / Solutions for different production needs.
Müşteri ihtiyaçlarına göre delik grubu ve freze grubu seçenekleri / Drilling group and milling group options according to customer needs.
Endüstriyel tasarım ile yüksek performans / High performance with industrial design.
3 - 4- 5 Eksen opsiyonları / 3-4- 5 Axis options.
Kısa işlem süreleri ve verimlilik artışı / Short processing times and increased productivity.

KALİBRE VE HASSAS ZIMPARA MAKİNELERİ



CASADEI

LIBRA 45

**1/2/3 Üniteli Otomatik Geniş
Bant Zımpara**

1/2/3 Unit automatic wide belt sanders

Daha büyük makinelerde bulunan teknik çözümlerle donatılmış olan LIBRA 45 geniş bantlı zımpara. Yüksek üretim oranlarıyla başa çıkabilen çok yönlü ve esnek bir makine. / Equipped with technical solutions normally found on larger machines, the LIBRA 45 wide belt sander is a versatile and flexible machine capable of coping with high production rates.

Opsiyonel 2/3 ünite. / 2/3 Unit options.

4-170 mm çalışma yüksekliği. / 4-170 mm working height.

1100-1350 mm çalışma genişliği. / Working width of 1100-1350 mm.

Kalibrasyon, kaplama, astar ve cila zımparası. / Calibration, veneer sanding, primer and polish sanding.

Planya opsiyonu. / Planing option.



CASADEI

LIBRA 55

**1/2/3 Üniteli Endüstriyel
Geniş Bant Zımpara**

1/2/3 Unit industrial automatic wide belt sanders

Esneklik, doğruluk, mükemmel yüzey ve üretkenlik için tasarlanmış endüstriyel makine. / A machine designed for the industry with requirements of flexibility, accuracy, excellent finishing and productivity.

Opsiyonel 2/3 ünite. / 2/3 Unit options.

4-170 mm çalışma yüksekliği. / 4-170 mm working height.

1350 mm çalışma genişliği. / Working width of 1350 mm.

Kalibrasyon, kaplama, astar ve cila zımparası. / Calibration, veneer sanding, primer and polish sanding.

Hat tipi makine / Line type machine.



KALİBRE VE HASSAS ZIMPARA MAKİNELERİ

CASADEI LIBRA 65 1/2/3 Üniteli Endüstriyel Geniş Bant Zımpara

1/2/3 Unit industrial automatic wide belt sander

Libra 65, yüksek kaliteli bir yüzey ve yüksek üretim kapasiteleri için tasarlanmış endüstriyel bir makine. / The Libra 65 is a machine designed for the large industry which requires a high quality finish and high production rates. Opsiyonel 2/3 ünite ile 10 farklı konfigürasyon / 10 different configurations with optionals 2/3 unit.
4-170 mm çalışma yüksekliği / 4-170 mm working height.
1350 mm çalışma genişliği / Working width of 1350 mm.
Kalibrasyon, kaplama, astar ve cila zımparası. / Calibration, veneer sanding, primer and polish sanding.
Hat tipi makine / Line type machine



PROFİL FREZE MAKİNELERİ

CASADEI MATRIX 230X Otomatik Profil Freze Makinesi

Automatic moulders

MATRIX 230, yıllarca süren ar-ge ile üretilen profil freze makinesi. Güvenilir ve üretken, en iyi sonuca ulaşmak için tasarlanmış ve kaliteli bileşenlerle üretilmiş. / MATRIX 230 is the result of years of researches and development into the engineering and manufacturing of automatic throughfeed moulders. Reliable and productive is built with quality components, designed and tested to reach the best results.
Maksimum çalışma genişliği 230 mm / Maximum working width 230 mm.
Maksimum çalışma yüksekliği 120 mm / Maximum working height 120 mm.
25 m/dak besleme hızı / 25 m / min feed speed.
4, 4+1, 5, 5+1 mil opsiyonu / 4, 4+1, 5, 5+1 spindle options.



ÇÖZÜM ORTAKLARIMIZ



ÇÖZÜM
ORTAKLARIMIZ
OUR SOLUTION
PARTNERS



**MAGGI BORING
SYSTEM 323**

Üç Kafalı Delik Makinesi /
Multispindle three-head boring machine.

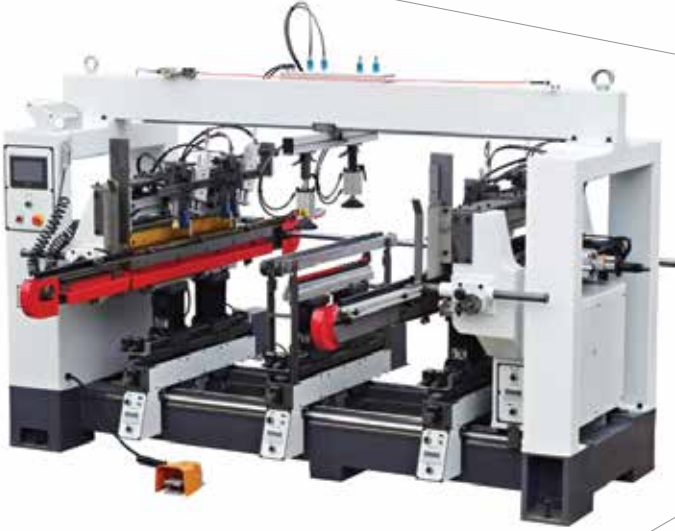

ÇEKMECE DELİK MAKİNESİ

Dört kafalı delik makinesi /
Four-head boring machine.
Dar parça besleme opsiyonu /
Narrow part feeding option.



CNC KONTROLLÜ DELİK MAKİNESİ

CNC controlled drilling machine

Delik ve freze ünite seçenekleri. /
Boring unit and routing unit options.
5 ya da 6 yüzeyde çalışabilme. /
Ability to work on 5 or 6 surfaces.



HAT TİPİ DELİK MAKİNESİ

Otomatik beslemeli delik makinesi. / Automatic through-feed boring machines
İhtiyaca göre delik ünite sayısı. / Number of drilling units according to need.
Delik ünite pozisyonlanması Manuel/ Pnömatik/ NC Kontrollü. /
Drilling unit positioning Manual / Pneumatic / NC Controlled.





SUPERSTAR F586G
Endüstriyel Kenar Bantlama Makinesi
Industrial edge banding machine



HOLD HY211
Endüstriyel Kenar Bantlama Makinesi (Soft, J, C, L, Açılı Kenarlar)
Industrial edge banding machine for Soft, J, C, L, X Type edges



Otomatik Fırça Zımpara Makinesi
Automatic brush sanding machine



Short Cycle Sıcak Pres Makineleri
Short Cycle Hot Press Machines



ÇÖZÜM
ORTAKLARIMIZ
OUR SOLUTION
PARTNERS



VITAP BC92

Yarı otomatik eğri kenar bantlama makinesi
Semi-automatic edge banding machines for shaped pieces



VITAP RC92

Yarı otomatik eğri kenar temizleme makinesi
Semi-automatic edge trimming machines for shaped pieces



ECLIPSE 2.0

Otomatik eğri kenar bantlama ve alt üst temizleme makinesi /
Automatic edgebanding and trimming machines for shaped pieces

Eğri kenar bantlama ve temizleme de dünyadaki en iyi makine /
World excellence for edgebanding and trimming

Point K2 2.0

CNC İşleme Merkezi
CNC Machining Center

Point K2 2.0, ahşap işleme için sayısal kontrol makinelerinin teknolojik evrimidir. 4 makinenin gücü devrim niteliğindeki bir işleme merkezinde toplanmıştır: kesme ünitesi, profil ünitesi, delme ünitesi, freze-nesting. /

Point K2 2.0 is the technological evolution of numerical control machines for wood processing. The power of 4 machines is concentrated in a revolutionary machining center: cutting unit, profile unit, drilling unit, routing-nesting.



SIGMA SERİSİ

Büyük Ölçekli Üretimler için Hat Tipi Delik Makinesi
Ideal wood boring machines for large-scale production

Otomatik beslemeli delme makineleri SIGMA B1-SIGMA B2
Automatic through-feed boring machines SIGMA B1-SIGMA B2

Enjektörlü otomatik beslemeli delme makineleri SIGMA B1TD-SIGMA B2TD
Automatic through-feed boring machines with injectors SIGMA B1TD-SIGMA B2TD





HOUFEK TWINGO

Fırçalama ve rustik makinesi. /

Brushing and rustic machine.

Ahşap, plastik, kompozit. /

Wood, plastics, composite.

Farklı genişlik ve ünite sayısı seçenekleri. /

Different width and number of units options.



ECOLINE PROFILSAND

Profil zımpara makinesi /

Profile sanding machine.



EMC PLANO SYSTEM

Patentli ROTARY hassas zımpara makinesi. /

Patented ROTARY finishing system.

Kalibre, hassas zımpara, polisaj ve alternatif çözümler. /

Calibration, fine sanding, polishing and alternative solutions.

Ahşap, metal, kompozit, plastik vb. metaryaller. /

Wood, metal, composite, plastic, etc. materials.

ÇÖZÜM
ORTAKLARIMIZ
OUR SOLUTION
PARTNERS



**CASATI MACCHINE
CIM31/CIO31**

Kaplama Kesme Makinesi. /
Veneer Cutting Machine.

Tek giyotin bıçak, çift giyotin bıçak ve
farklı kesim uzunluk opsiyonları. /
Single guillotine blade, double guillotine blade and
different cutting length options.



**CASATI MACCHINE
LINEA SERİSİ**

Kaplama birleştirme makineleri. /
Coating joining machines.



OSAMA S4R-P

Tutkal sürme makinesi. /
Glue application machine.





OMC PL/PLC SERİSİ

Sıcak pres. / Hot press.

Farklı plaka, ısıtma ve ölçü seçenekleri. / Different plate, heating and size options.

Kapasite ihtiyaçlarına göre ara kat opsiyonları. / Middle floor options according to capacity needs.



OMC MEMBRAN PRES

Pin sistemi (Otomatik ya da manuel). / Jig system (Automatic or manual).

Farklı tabla ölçü seçenekleri. / Different table size options.



OMGA OPTIMA 240

Otomatik budak ayırma ve boylama makinesi. / High speed automatic push fed saw for optimized cutting and defect removal.

ÇÖZÜM
ORTAKLARIMIZ
OUR SOLUTION
PARTNERS



REIGNMAC D60M-D80M-D120M

Doppel ebatlama, hassas ebatlama makineleri. / Double end tenoner.

Tek makine ya da kapasiteye göre hat tipi çözümler. / Single machine or line type solutions by capacity.



REIGNMAC M23

Otomatik profil freze makineleri. / Automatic four-side moulder.



REIGNMAC RMS Serisi

Tek ya da çift milli çoklu dilme makineleri. / Multi-rip saw.





ESSEPIGI DOORMATIC

Tek ya da hat tipi kapı imalat çözümleri. / Single or line type door producing solutions.

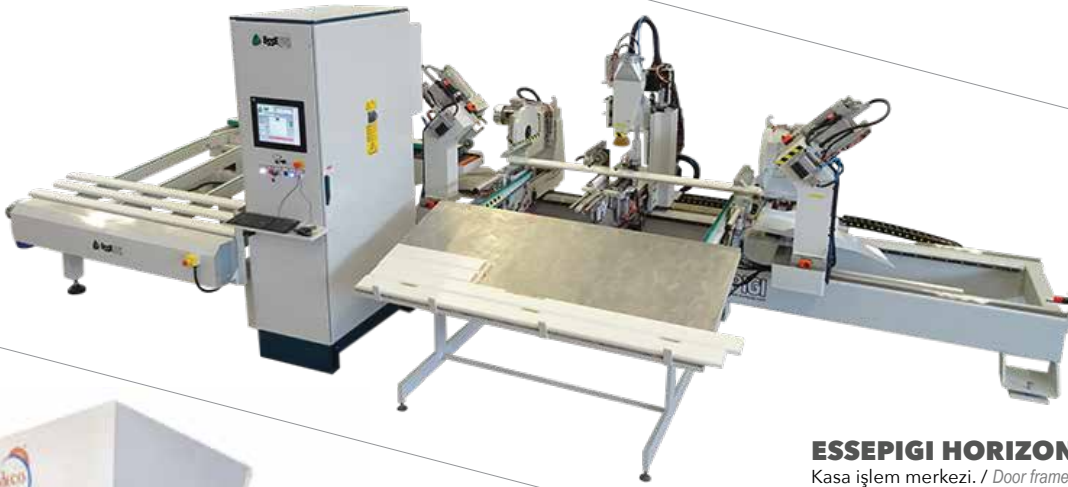

ESSEPIGI HORIZON PLUS

Kasa işlem merkezi. / Door frames processing.
Kesme, delme ve frezeleme. / Sizing, drilling and milling.



PRODECO SHREDDER SERİSİ

Ahşap kırıcı makine. / Wood breaker machine.

PRODECO VERTICAL SERİSİ

Briket presi. / Briquetting presse.



HIGH GLOSS HATTI

Uv roller hattı, farklı konfigürasyon seçenekleri. / Roller coating production line, different configuration options.

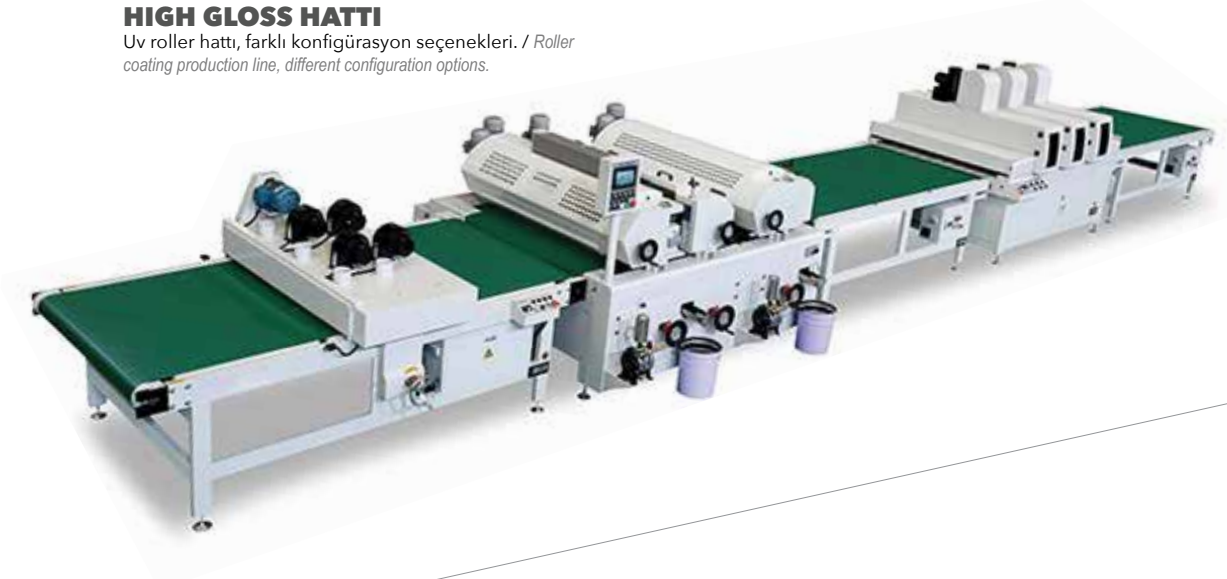

OTOMATİK SPREY ATIM MAKİNELERİ

Otomatik spreysel hat. Tek ya da hat tipi çözümler. / Automatic spraying line. Single or line type solutions.



LAMİNASYON HAT MAKİNELERİ

Otomatik laminasyon hattı. / Automatic laminating line.





PLASTICBAND ATIS SERİSİ
Otomatik Streç Sarma Makinesi



ERREGI TECNOPRESS VR2
Kutu toplama presi. / Assemblage / Box press.



ERREGI COMPACT 250
Otomatik shrink ambalaj hattı. / Automatic shrink wrapping line.



CNC KARTON KESME MAKİNESİ

Cnc karton kesme makinesi. /
Cnc cardboard cutting machine

Sonsuz karton levhanın otomatik olarak kesilmesini ve
kırım yerlerinin oluşturulmasını sağlar. /
Enables automatically cutting andfolding of endless cardboard sheet.

CMT ORANGE
TOOLS®

ORMEND MAKİNA SAN. TİC. LTD. ŞTİ.
CMT ORANGE TOOLS ÜRÜNLERİNİN BAYİLERE DAĞITIMI VE TÜRKİYE
GENELİNDE TEMSİLCİLİK KONUSUNDA TEK YETKİLİDİR.

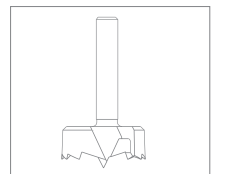
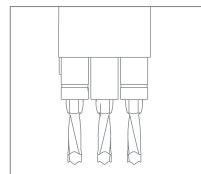
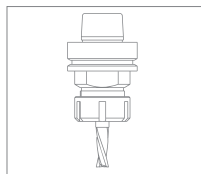
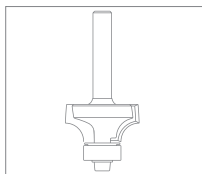
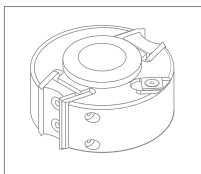
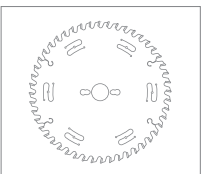

NOTLAR

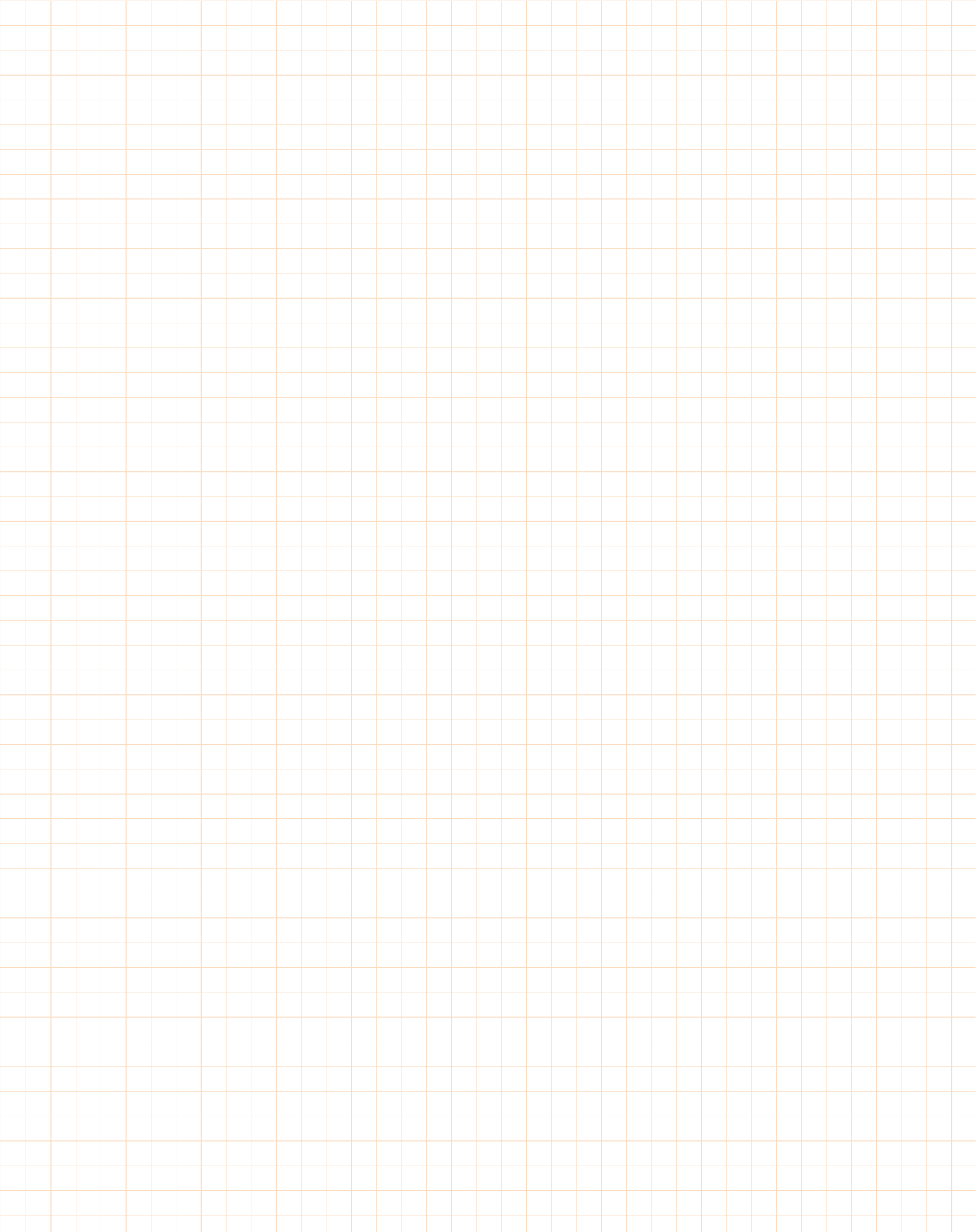



ORMEND
MAKİNA SAN. TİC. LTD. ŞTİ.

Şerifali Mah. Türker Cad. No: 32/A,
34775, Ümraniye / İstanbul / TÜRKİYE
T: +90 216 527 01 12 - 13
F: +90 216 527 01 14
info@ormendmakina.com
www.ormendmakina.com



ormendmakina



ormendmakina



ormendmakina



ormendmakina