



KESİCİ TAKIMLAR KATALOĞU

TEKNOLOJİDE
ÇÖZÜM ORTAĞINIZ

► 2023 FİYAT LİSTESİ

CMT ORANGE
TOOLS®

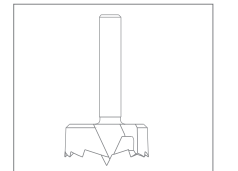
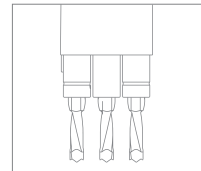
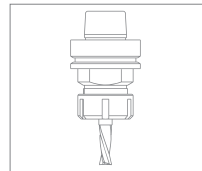
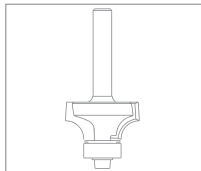
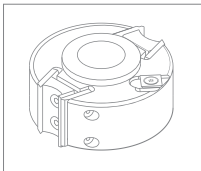
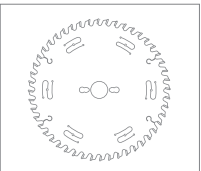

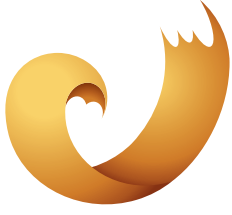

ORMEND
MAKINA SAN. TİC. LTD. ŞTİ.

ORMEND MAKİNE

TEKNOLOJİDE ÇÖZÜM ORTAĞINIZ

Ahşap işleme makinaları, kesici takımlar, yedek parça ve teknik servis konularında iş ortaklarımızın daima yanında olmak ve teknolojideki son yenilikleri sizlerle buluşturmak hedefindeyiz.

20 yılı aşkın tecrübemiz, konusunda uzman kadromuzun bilgi ve donanımı ile birlikte siz değerli iş ortaklarımızın ihtiyaçlarına en uygun çözümler üretmek en temel ilkemizdir.

ORMEND ailesi olarak biz, ahşap işleme makinaları ve kesici takım üreten dünyadaki en değerli markaların mümessilliğini yapmanın gururunu yaşamamızın yanında, kendimizi iş ortaklarımıza layık olabilmek adına sürekli geliştirmekteyiz. Ürün satışının dışında, satış sonrasında sizler için ne derece önemli olduğunu bilincindeyiz. Bundan dolayı teknik servis ve yedek parça konularında sizlere en hızlı hizmeti sağlamak için çalışıyoruz.

Saygılarımızla,

ORMEND MACHINE,

YOUR SOLUTION PARTNER IN TECHNOLOGY

We aim to always be with our business partners in wood processing machines, cutting tools, spare parts and technical service and bring you the latest innovations in technology.

Our basic principle is to produce the most suitable solutions for the needs of our valued business partners, with our experience of more than 20 years and the knowledge and equipment of our expert staff.

As the Ormend Family, we are proud to represent the most valuable brands in the world that produce wood processing machines and cutting tools and we are constantly improving to be worthy to our business partners. Apart from product sales, we are aware of how important after sales is for you, so we are working to provide you with the fastest service in technical service and spare parts.

Regards



| | | |
|---|------------------------------------|-----------|
|  | STANDART TESTERELER | 3 |
|  | DİA TESTERELER | 13 |
|  | PANEL EBATLAMA TESTERELER | 15 |
|  | MATKAP UÇLARI ve MANDRENLER | 19 |
|  | KARBÜR ve DİA FREZELER | 29 |
|  | FREZE BIÇAKLARI | 35 |
|  | JİLETLİ FREZE TOPLARI | 42 |
|  | JİLETLER ve PLANYALAR | 45 |
|  | POLİÜRETAN HORTUMLAR | 46 |

STANDART TESTERELER

CMT ORANGE
TOOLS®





MDF & SUNTALAM TESTERELER

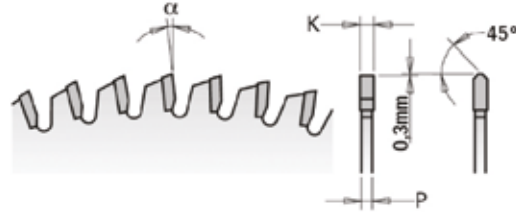

MÜKEMMEL

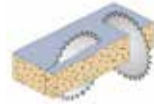

IV



| Order No. | D | K | P | d | Z | FT | α | β | Fiyat |
|-------------|-----|-----|-----|----|-----|---------|----------|---------|----------|
| 281.160.40H | 160 | 2.2 | 1.6 | 20 | 40 | 4/7/32 | 10° | TCG | 52,00 € |
| 281.064.08M | 200 | 3.2 | 2.2 | 30 | 64 | 2/7/42 | 10° | TCG | 59,00 € |
| 281.064.09M | 220 | 3.2 | 2.2 | 30 | 64 | 2/7/42 | 10° | TCG | 55,00 € |
| 281.080.10M | 250 | 3.2 | 2.2 | 30 | 80 | 2/10/60 | 10° | TCG | 64,00 € |
| 281.072.12M | 300 | 3.2 | 2.2 | 30 | 72 | 2/10/60 | 10° | TCG | 67,00 € |
| 281.096.12M | 300 | 3.2 | 2.2 | 30 | 96 | 2/10/60 | 10° | TCG | 74,50 € |
| 281.084.14M | 350 | 3.5 | 2.5 | 30 | 84 | 2/10/60 | 10° | TCG | 89,00 € |
| 281.108.14M | 350 | 3.5 | 2.5 | 30 | 108 | 2/10/60 | 10° | TCG | 102,00 € |



CHROME MDF & SUNTALAM TESTERELER



MÜKEMMEL



| Order No. | D | K | P | d | Z | FT | α | β | Fiyat |
|-------------|-----|-----|-----|----|-----|---------|----------|---------|----------|
| 281.680.10M | 250 | 3.2 | 2.2 | 30 | 80 | 2/10/60 | 5° | TCG | 85,50 € |
| 281.672.12M | 300 | 3.2 | 2.2 | 30 | 72 | 2/10/60 | 10° | TCG | 84,50 € |
| 281.696.12M | 300 | 3.2 | 2.2 | 30 | 96 | 2/10/60 | 5° | TCG | 90,00 € |
| 281.708.14M | 350 | 3.5 | 2.5 | 30 | 108 | 2/10/60 | 5° | TCG | 130,00 € |

TEKLİ ÇİZİCİ TESTERELER

ÇİFTLİ ÇİZİCİ TESTERELER

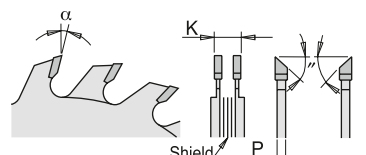
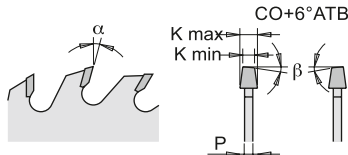

| Order No. | D | K | FT | d | Z | | α | β | Fiyat |
|-------------|-----|---------|----------|----|-------|---------------|----------|-----------|---------|
| 288.125.24H | 125 | 3.1-4.0 | | 20 | 24 | Tekli | 5° | CO+5° ATB | 48,00 € |
| 288.725.24H | 125 | 3.1-4.3 | | 20 | 24 | Tekli Chrome | 0° | CO+6° ATB | 50,00 € |
| 288.125.24K | 125 | 3.1-4.0 | | 22 | 24 | Tekli | 5° | CO+5° ATB | 50,00 € |
| 289.725.24H | 125 | 2.8-3.6 | 2/4.2/42 | 20 | 12+12 | Çiftli Chrome | 11° | 5° ATB | 84,00 € |

*Fiyatlarımıza KDV Dahil Değildir.

*Diğer ölçüler için lütfen iletişime geçin.

ÇOKLU DİLME TESTERELER

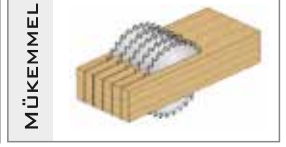
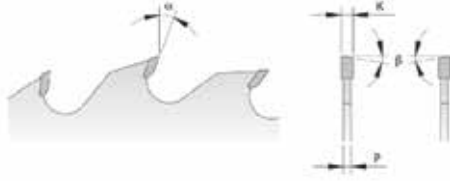

| Order No. | D | K | P | T ₁ mm | d | Z | KAMA - PİN | α | β | Fiyat |
|-------------|-----|-----|-----|-------------------|-----|------|------------|-----|---------|----------|
| 280.021.08S | 200 | 2.5 | 1.8 | 35 | 40 | 21+3 | | 18° | FLAT | 70,00 € |
| 279.020.10M | 250 | 3.2 | 2.2 | 65 | 30* | 20+4 | COMBI 3 | 18° | 10° ATB | 70,00 € |
| 280.020.10V | 250 | 2.7 | 1.8 | 50 | 70 | 20+4 | 21x8 | 18° | 10° ATB | 70,00 € |
| 279.024.12M | 300 | 3.2 | 2.2 | 80 | 30* | 24+4 | COMBI 3 | 18° | 10° ATB | 80,00 € |
| 279.024.12V | 300 | 3.2 | 2.2 | 80 | 70 | 24+4 | 21x8 | 18° | 10° ATB | 80,00 € |
| 279.028.14M | 350 | 3.5 | 2.5 | 105 | 30* | 28+4 | COMBI 3 | 18° | 10° ATB | 100,00 € |
| 279.028.14V | 350 | 3.5 | 2.5 | 105 | 70 | 28+4 | 21x6 | 18° | 10° ATB | 100,00 € |
| 279.028.16M | 400 | 4.0 | 2.8 | 120 | 30* | 28+6 | COMBI 3 | 18° | 10° ATB | 150,00 € |

* İstenilen ölçülere göre göbek ve kama deliği ayarlanabilir.

AHŞAP KESİM TESTERELER (Atlamalı Diş)

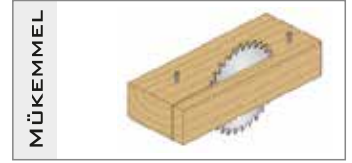
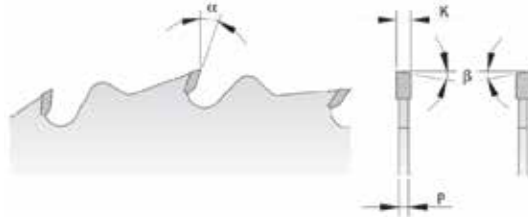

| Order No. | D | K | P | d | Z | FT | α | β | Fiyat |
|-------------|-----|-----|-----|----|----|---------|-----|---------|----------|
| 290.250.24M | 250 | 2.8 | 1.8 | 30 | 24 | 2/10/60 | 20° | 10° ATB | 32,50 € |
| 278.028.12M | 300 | 3.2 | 2.2 | 30 | 28 | 2/10/60 | 18° | 10° ATB | 50,00 € |
| 286.020.12M | 300 | 2.8 | 1.8 | 30 | 20 | 2/10/60 | 15° | 5° ATB | 39,00 € |
| 278.036.14M | 350 | 3.5 | 2.5 | 30 | 36 | 2/10/60 | 18° | 10° ATB | 63,00 € |
| 285.036.16M | 400 | 3.5 | 2.5 | 30 | 36 | 2/10/60 | 20° | 10° ATB | 68,00 € |
| 285.036.18M | 450 | 3.8 | 2.8 | 30 | 36 | 2/10/60 | 20° | 10° ATB | 74,50 € |
| 285.044.20M | 500 | 4.0 | 2.8 | 30 | 44 | 2/10/60 | 20° | 10° ATB | 109,00 € |
| 286.040.22M | 550 | 4.2 | 3.2 | 30 | 40 | 2/10/60 | 15° | 5° ATB | 109,00 € |
| 286.040.24M | 600 | 4.2 | 3.2 | 30 | 40 | 2/10/60 | 15° | 5° ATB | 118,00 € |
| 286.046.28M | 700 | 4.4 | 3.2 | 30 | 46 | 2/10/60 | 15° | 5° ATB | 163,00 € |

ULTRA HASSAS KESİM TESTERE (SAĞ-SOL)

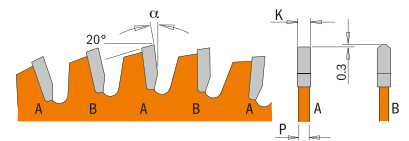
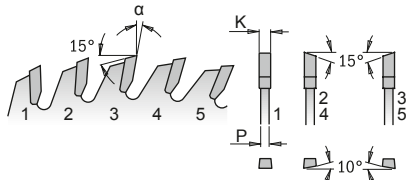

| Order No. | D | K | P | d | Z | FT | α | β | Fiyat |
|--------------------|-----|-----|-----|----|-----|---------|---------|-----------|---------|
| 274.100.12M | 300 | 3.2 | 2.2 | 30 | 100 | 2/10/60 | 15° | 1FTG+4ATB | 96,00 € |
| 276.300.96M (DECK) | 300 | 2.8 | 2.0 | 30 | 96 | 2/10/60 | -6°NEG. | TCG | 80,00 € |

*Fiyatlarımıza KDV Dahil Değildir.

*Diğer ölçüler için lütfen iletişime geçin.



AHŞAP ve KAPLAMALI MALZEME KESİM TESTERELER (Sık Diş)

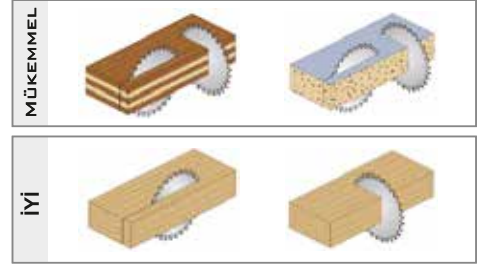
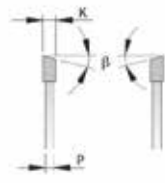

| Order No. | D | K | P | d | Z | FT | α | β | Fiyat |
|-------------|-----|-----|-----|----|----|------------------|----------|---------|----------|
| 285.056.07M | 180 | 3.2 | 2.2 | 30 | 56 | 2/7/42 | 5° | 15° ATB | 50,00 € |
| 285.048.08M | 200 | 3.2 | 2.2 | 30 | 48 | 2/10/60 + 2/7/42 | 15° | 15° ATB | 47,00 € |
| 285.048.10M | 250 | 3.2 | 2.2 | 30 | 48 | 2/10/60 | 15° | 10° ATB | 48,00 € |
| 285.060.10M | 250 | 3.2 | 2.2 | 30 | 60 | 2/10/60 | 10° | 15° ATB | 50,00 € |
| 285.080.10M | 250 | 3.2 | 2.2 | 30 | 80 | 2/10/60 | 5° | 15° ATB | 68,00 € |
| 285.060.11M | 260 | 2.8 | 1.8 | 30 | 60 | 2/10/60 + 2/7/42 | 10° | 15° ATB | 55,00 € |
| 295.064.11M | 280 | 2.8 | 1.8 | 30 | 64 | 2/10/60 + 2/7/42 | 10° | 15° ATB | 70,00 € |
| 285.048.12M | 300 | 3.2 | 2.2 | 30 | 48 | 2/10/60 | 15° | 10° ATB | 54,00 € |
| 285.060.12M | 300 | 3.2 | 2.2 | 30 | 60 | 2/10/60 | 15° | 10° ATB | 60,00 € |
| 285.072.12M | 300 | 3.2 | 2.2 | 30 | 72 | 2/10/60 | 10° | 15° ATB | 67,00 € |
| 285.096.12M | 300 | 3.2 | 2.2 | 30 | 96 | 2/10/60 | 5° | 15° ATB | 80,00 € |
| 285.072.22M | 305 | 3.2 | 2.2 | 30 | 72 | 2/10/60 | 10° | 15° ATB | 75,00 € |
| 285.072.13M | 315 | 3.2 | 2.2 | 30 | 72 | 2/10/60 | 15° | 10° ATB | 75,00 € |
| 285.054.14M | 350 | 3.5 | 2.5 | 30 | 54 | 2/10/60 | 15° | 10° ATB | 69,00 € |
| 285.072.14M | 350 | 3.5 | 2.5 | 30 | 72 | 2/10/60 | 15° | 10° ATB | 74,50 € |
| 285.084.14M | 350 | 3.5 | 2.5 | 30 | 84 | 2/10/60 | 10° | 15° ATB | 88,00 € |
| 285.048.16M | 400 | 3.5 | 2.5 | 30 | 48 | 2/10/60 | 20° | 10° ATB | 81,00 € |
| 285.060.16M | 400 | 3.5 | 2.5 | 30 | 60 | 2/10/60 | 10° | 15° ATB | 93,00 € |
| 285.054.18M | 450 | 3.8 | 2.8 | 30 | 54 | 2/10/60 | 15° | 15° ATB | 106,00 € |
| 285.066.18M | 450 | 3.8 | 2.8 | 30 | 66 | 2/10/60 | 10° | 15° ATB | 128,00 € |
| 285.060.20M | 500 | 3.8 | 2.8 | 30 | 60 | 2/10/60 | 15° | 15° ATB | 126,00 € |
| 285.072.20M | 500 | 3.8 | 2.8 | 30 | 72 | 2/10/60 | 10° | 15° ATB | 151,00 € |
| 285.060.22M | 550 | 4.2 | 3.2 | 30 | 60 | 2/10/60 | 10° | 15° ATB | 145,00 € |
| 285.066.24M | 600 | 4.2 | 3.2 | 30 | 66 | 2/10/60 | 10° | 15° ATB | 151,00 € |
| 285.072.28M | 700 | 4.4 | 3.2 | 30 | 72 | 2/10/60 | 10° | 15° ATB | 199,00 € |

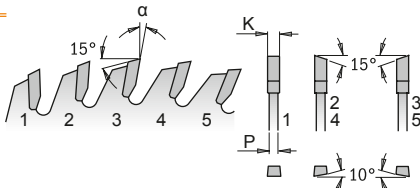

ULTRA İNCE TESTERELER (AHŞAP KESİM)

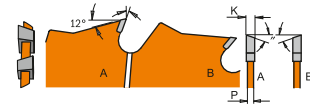

| Order No. | D | K | P | d | Z | FT | α | β | Fiyat |
|----------------|-----|-----|-----|----|----|---------|----------|------------|---------|
| 273.300.96M | 300 | 2.6 | 1.8 | 30 | 96 | 2/10/60 | 12° | 10° ATB+8° | 76,00 € |
| 273.250.80M | 250 | 2.4 | 1.6 | 30 | 80 | 2/10/60 | 12° | 10° ATB+8° | 53,00 € |
| 271.300.48M | 300 | 2.6 | 1.8 | 30 | 48 | 2/10/60 | 18° | 10° ATB+8° | 55,00 € |
| 271.300.24M BG | 300 | 2.6 | 1.8 | 30 | 24 | 2/10/60 | 22° | 10° ATB+8° | 45,00 € |
| 271.250.42M | 250 | 2.4 | 1.6 | 30 | 42 | 2/10/60 | 18° | 10° ATB+8° | 42,00 € |
| 271.250.24M BG | 250 | 2.4 | 1.6 | 30 | 24 | 2/10/60 | 20° | 10° ATB+8° | 32,00 € |
| S 272.04180 X | 250 | 2.2 | 1.6 | 30 | 40 | 2/10/60 | 20° | 1FTG+4ATB | 49,00 € |

*Fiyatlarımıza KDV Dahil Değildir.

*Diğer ölçüler için lütfen iletişime geçin.



CHROME KURT DİŞ MDFLAM TESTERELER

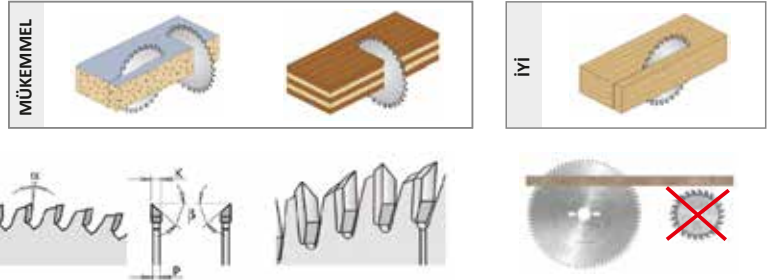

| Order No. | D | K | P | d | Z | FT | α | β | Fiyat |
|-------------|-----|-----|-----|----|----|---------|-----------|---------|----------|
| 283.680.10M | 250 | 3.2 | 2.2 | 30 | 80 | 2/10/60 | - 2° Neg. | 38° ATB | 86,00 € |
| 283.696.12M | 300 | 3.2 | 2.2 | 30 | 96 | 2/10/60 | 2° | 38° ATB | 105,00 € |

KURT DİŞ MDFLAM TESTERELER

| Order No. | D | K | P | d | Z | FT | α | β | Fiyat |
|-------------|-----|-----|-----|----|-----|---------|----------|---------|----------|
| 283.080.10M | 250 | 3.2 | 2.2 | 30 | 80 | 2/10/60 | -2° Neg. | 40° ATB | 74,50 € |
| 283.096.12M | 300 | 3.2 | 2.2 | 30 | 96 | 2/10/60 | 2° | 40° ATB | 90,00 € |
| 283.108.14M | 350 | 3.5 | 2.5 | 30 | 108 | 2/10/60 | 5° | 40° ATB | 109,00 € |

CHROME AHŞAP ve KAPLAMALI MALZEME KESİM TESTERELER (Sık Diş)

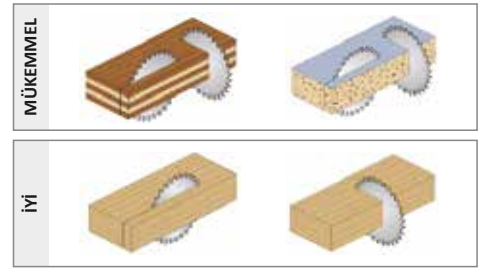
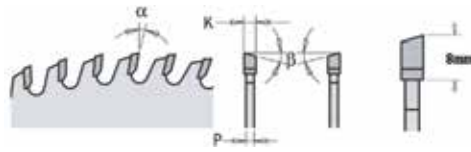

| Order No. | D | K | P | d | Z | FT | α | β | Fiyat |
|-------------|-----|-----|-----|----|-----|---------|----------|---------|----------|
| 285.640.10M | 250 | 3.2 | 2.2 | 30 | 40 | 2/10/60 | 15° | 10° ATB | 52,00 € |
| 285.660.10M | 250 | 3.2 | 2.2 | 30 | 60 | 2/10/60 | 10° | 15° ATB | 62,50 € |
| 285.680.10M | 250 | 3.2 | 2.2 | 30 | 80 | 2/10/60 | 5° | 15° ATB | 83,00 € |
| 285.648.12M | 300 | 3.2 | 2.2 | 30 | 48 | 2/10/60 | 15° | 10° ATB | 73,00 € |
| 285.672.12M | 300 | 3.2 | 2.2 | 30 | 72 | 2/10/60 | 10° | 15° ATB | 81,00 € |
| 285.696.12M | 300 | 3.2 | 2.2 | 30 | 96 | 2/10/60 | 5° | 15° ATB | 100,00 € |
| 285.654.14M | 350 | 3.5 | 2.5 | 30 | 54 | 2/10/60 | 15° | 10° ATB | 89,00 € |
| 285.684.14M | 350 | 3.5 | 2.5 | 30 | 84 | 2/10/60 | 10° | 15° ATB | 107,00 € |
| 285.708.14M | 350 | 3.5 | 2.5 | 30 | 108 | 2/10/60 | 5° | 15° ATB | 123,00 € |

*Diğer ölçüler için lütfen iletişime geçin.

*Fiyatlarımıza KDV Dahil Değildir.



CHROME OLUKLU DİŞ HASSAS KESİM TESTERELER

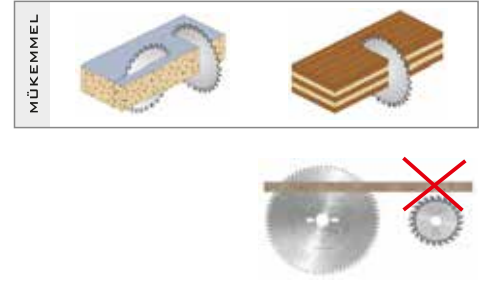
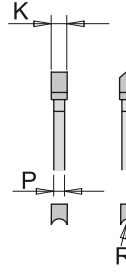

| Order No. | D | K | P | d | Z | FT | α | β | Fiyat |
|-------------|-----|-----|-----|----|----|---------|----------|---------|----------|
| 287.648.10M | 250 | 3.2 | 2.2 | 30 | 48 | 2/10/60 | 10° | HDF | 90,00 € |
| 287.660.12M | 303 | 3.2 | 2.2 | 30 | 60 | 2/10/60 | 10° | HDF | 110,00 € |

OLUKLU DİŞ HASSAS KESİM TESTERELER

| Order No. | D | K | P | d | Z | FT | α | β | Fiyat |
|-------------|-----|-----|-----|----|----|---------|----------|---------|---------|
| 287.048.10M | 250 | 3.2 | 2.2 | 30 | 48 | 2/10/60 | 10° | HDF | 78,00 € |
| 287.060.12M | 303 | 3.2 | 2.2 | 30 | 60 | 2/10/60 | 10° | HDF | 98,00 € |

PORTATİF MAKİNA TESTERELER

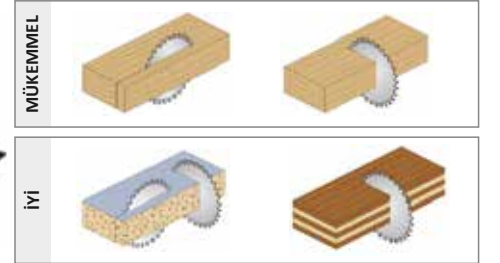

| Order No. | D | K | P | d | Z | FT | α | β | Fiyat |
|--------------|-----|-----|-----|-------|----|---------|----------|---------|---------|
| 291.160.24M | 160 | 2.2 | 1.6 | 30 | 24 | 2/7/42 | 15° | 15° ATB | 26,00 € |
| 292.160.40H | 160 | 2.2 | 1.6 | 20 | 40 | 2/6/32 | 10° | 15° ATB | 33,00 € |
| 292.160.40M | 160 | 2.2 | 1.6 | 30 | 40 | 2/7/42 | 10° | 15° ATB | 33,00 € |
| 285.160.48H | 160 | 2.2 | 1.6 | 20 | 48 | 2/6/32 | 5° | 15° ATB | 37,00 € |
| 291.180.24H | 180 | 2.6 | 1.6 | 20 | 24 | 2/6/32 | 20° | 10° ATB | 28,00 € |
| 291.180.24M | 180 | 2.6 | 1.6 | 30 | 24 | 2/7/42 | 20° | 10° ATB | 28,00 € |
| 292.180.40H | 180 | 2.6 | 1.6 | 20 | 40 | 2/6/32 | 15° | 15° ATB | 36,00 € |
| 292.180.40M | 180 | 2.6 | 1.6 | 30 | 40 | 2/7/42 | 15° | 15° ATB | 36,00 € |
| 291.190.24H | 190 | 2.6 | 1.6 | 20 | 24 | 2/6/32 | 20° | 10° ATB | 29,00 € |
| 291.190.24M | 190 | 2.6 | 1.6 | 30 | 24 | 2/7/42 | 20° | 10° ATB | 29,00 € |
| 292.190.40M | 190 | 2.6 | 1.6 | 30 | 40 | 2/7/42 | 15° | 15° ATB | 36,00 € |
| 292.190.48FF | 190 | 2.4 | 1.8 | 20-16 | 48 | 5/7/2,5 | 10° | 15° ATB | 41,00 € |
| 291.200.36M | 200 | 2.8 | 1.8 | 30 | 36 | 2/7/42 | 15° | 15° ATB | 39,00 € |
| 292.200.48M | 200 | 2.8 | 1.8 | 30 | 48 | 2/7/42 | 15° | 15° ATB | 41,00 € |
| 292.210.64M | 210 | 2.8 | 1.8 | 30 | 64 | 2/7/42 | 15° | 15° ATB | 54,00 € |

*Fiyatlarımıza KDV Dahil Değildir.

*Diğer ölçüler için lütfen iletişime geçin.

CORIAN ve DOLU MALZEME KESİM TESTERELER

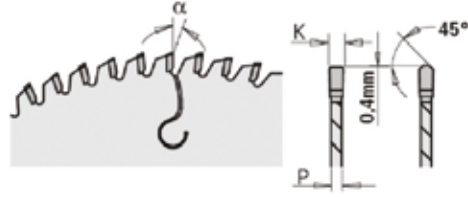

| Order No. | D | K | P | d | Z | FT | α | β | Fiyat |
|-------------|-----|-----|-----|----|----|----|----------|---------|---------|
| 223.072.10M | 250 | 3.2 | 2.5 | 30 | 72 | | 0° | MTCG | 74,00 € |
| 223.084.12M | 300 | 3.2 | 2.5 | 30 | 84 | | 0° | MTCG | 82,00 € |

PVC & PLEXIGLASS TESTERELER

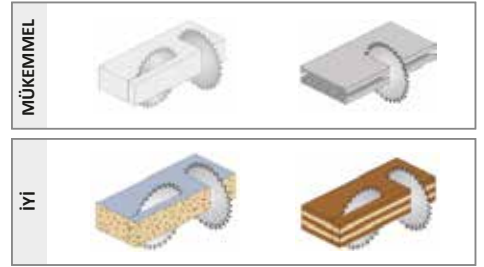
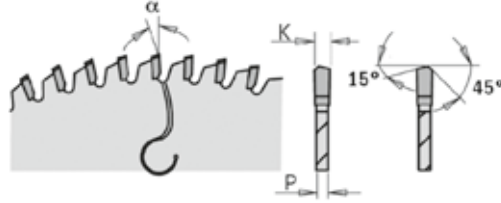

| Order No. | D | K | P | d | Z | FT | α | β | Fiyat |
|-------------|-----|-----|-----|----|----|---------|----------|---------|---------|
| 222.080.10M | 250 | 2.8 | 2.2 | 30 | 80 | 2/10/60 | -3°Neg. | MATB | 78,00 € |
| 222.096.12M | 300 | 2.8 | 2.2 | 30 | 96 | 2/10/60 | -3°Neg. | MATB | 95,00 € |

ÇİM BİÇME TESTERELER

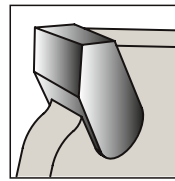
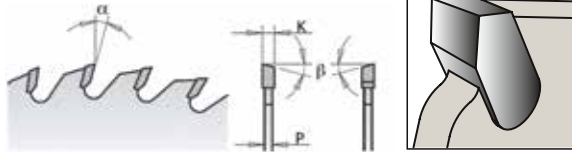

| Order No. | D | K | P | d | Z | RPM _{max.} | α | β | Fiyat |
|------------|-----|-----|-----|------|----|---------------------|----------|---------|---------|
| 298.250.20 | 250 | 2.2 | 1.4 | 25.4 | 20 | 12.000 | 15° | 10° ATB | 27,00 € |

*Diğer ölçüler için lütfen iletişime geçin.

*Fiyatlarımıza KDV Dahil Değildir.



(DRY CUT) METAL PROFİL KESİM TESTERELER

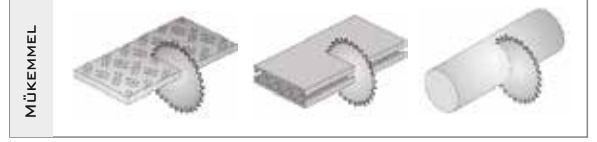
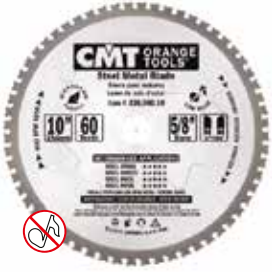

MÜKEMMEL

| Order No. | D | K | P | d | Z | RPM | FT | α | β | Fiyat |
|-------------|-----|-----|-----|-------|----|------|--------|----------|---------|----------|
| 226.032.06H | 150 | 1.6 | 1.2 | 20 | 32 | 4400 | | 0° | 8° FWF | 42,00 € |
| 226.036.06 | 165 | 1.6 | 1.2 | 15.87 | 36 | 4000 | | 0° | 8° FWF | 46,00 € |
| 226.048.07 | 184 | 2.0 | 1.6 | 15.87 | 48 | 3600 | | 0° | 8° FWF | 61,00 € |
| 226.040.07M | 190 | 2.0 | 1.6 | 30 | 40 | 3500 | 2/7/42 | 0° | 8° FWF | 55,00 € |
| 226.048.08M | 210 | 2.2 | 1.8 | 30 | 48 | 3100 | 2/7/42 | 0° | 8° FWF | 62,00 € |
| 226.048.09M | 235 | 2.2 | 1.8 | 30 | 48 | 3000 | 2/7/42 | 0° | 8° FWF | 67,00 € |
| 226.060.10 | 254 | 2.2 | 1.8 | 15.87 | 60 | 2600 | | 0° | 8° FWF | 100,00 € |
| 226.060.10M | 254 | 2.2 | 1.8 | 30 | 60 | 2600 | COMBI3 | 0° | 8° FWF | 100,00 € |
| 226.060.12 | 305 | 2.2 | 1.8 | 25.4 | 60 | 2100 | | 0° | 8° FWF | 106,00 € |
| 226.080.12 | 305 | 2.2 | 1.8 | 25.4 | 80 | 2100 | | 0° | 8° FWF | 133,00 € |
| 226.080.12M | 305 | 2.2 | 1.8 | 30 | 80 | 2100 | COMBI3 | 0° | 8° FWF | 133,00 € |
| 226.072.14 | 355 | 2.2 | 1.8 | 25.4 | 72 | 1800 | | 0° | 8° FWF | 115,00 € |
| 226.090.14 | 355 | 2.2 | 1.8 | 25.4 | 90 | 1800 | | 0° | 8° FWF | 145,00 € |
| 226.090.14M | 355 | 2.2 | 1.8 | 30 | 90 | 1800 | COMBI3 | 0° | 8° FWF | 145,00 € |

(DRY CUT) PASLANMAZ ÇELİK PROFİL KESİM TESTERELER

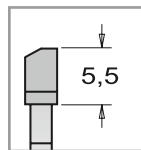

Stainless Steel

SPECIAL CARBIDE
CERMET

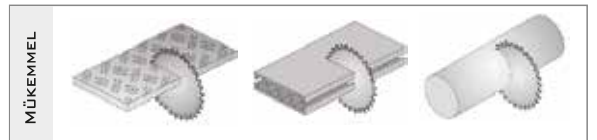

MÜKEMMEL

| Order No. | D | K | P | d | Z | RPM | FT | α | β | Fiyat |
|-------------|-----|-----|-----|------|----|------|--------|----------|---------|----------|
| 226.580.12 | 305 | 2.2 | 1.8 | 25.4 | 80 | 2100 | | 0° | 8° FWF | 155,00 € |
| 226.580.12M | 300 | 2.2 | 1.8 | 30 | 80 | 2200 | COMBI3 | 0° | 8° FWF | 155,00 € |
| 226.590.14 | 355 | 2.2 | 1.8 | 25.4 | 90 | 1800 | | 0° | 8° FWF | 170,00 € |
| 226.590.14M | 355 | 2.2 | 1.8 | 30 | 90 | 1800 | COMBI3 | 0° | 8° FWF | 170,00 € |

*Fiyatlarımıza KDV Dahil Değildir.

*Diğer ölçüler için lütfen iletişime geçin.

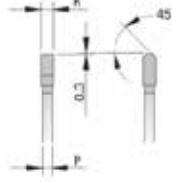
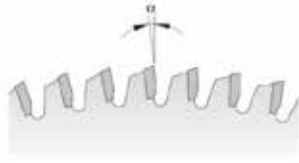

ALÜMİNYUM TESTERELER



| Order No. | D | K | P | d | Z | FT | α | FİYAT |
|-------------|-----|-----|-----|----|-----|---------|----------|----------|
| 297.080.10M | 250 | 3,2 | 2,5 | 30 | 80 | COMBI 3 | -6° Neg. | 70,00 € |
| 297.080.10P | 250 | 3,2 | 2,5 | 32 | 80 | 2/12/64 | -6° Neg. | 70,00 € |
| 297.096.12M | 300 | 3,2 | 2,5 | 30 | 96 | COMBI 3 | -6° Neg. | 79,00 € |
| 297.096.12P | 300 | 3,2 | 2,5 | 32 | 96 | 2/12/64 | -6° Neg. | 79,00 € |
| 297.108.14M | 350 | 3,6 | 3,0 | 30 | 108 | COMBI 3 | -6° Neg. | 95,00 € |
| 297.108.14P | 350 | 3,6 | 3,0 | 32 | 108 | 4/12/64 | -6° Neg. | 95,00 € |
| 297.108.16P | 400 | 4,0 | 3,2 | 32 | 96 | 4/12/64 | -6° Neg. | 134,00 € |
| 297.120.16M | 400 | 4,0 | 3,2 | 30 | 120 | 2/10/60 | -6° Neg. | 155,00 € |
| 297.120.16P | 400 | 4,0 | 3,2 | 32 | 120 | 4/12/64 | -6° Neg. | 155,00 € |
| 297.108.18M | 450 | 4,2 | 3,5 | 30 | 96 | 2/10/60 | -6° Neg. | 160,00 € |
| 297.108.18P | 450 | 4,2 | 3,5 | 32 | 96 | 2/12/64 | -6° Neg. | 160,00 € |
| 297.120.18P | 450 | 4,2 | 3,5 | 32 | 120 | 4/12/64 | -6° Neg. | 165,00 € |
| 297.120.20M | 500 | 4,3 | 3,5 | 30 | 120 | 2/10/60 | -6° Neg. | 170,00 € |
| 297.120.20P | 500 | 4,3 | 3,5 | 32 | 120 | 2/12/64 | -6° Neg. | 170,00 € |

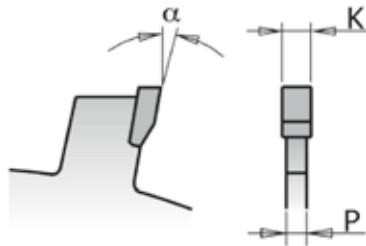

KANAL TESTERELER

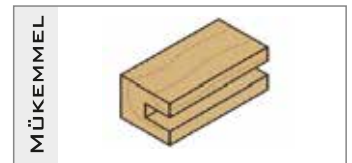

| Order No. | D | K | P | d | Z | FT | α | β | Fiyat |
|-------------|-----|-----|-----|----|----|----|----------|---------|---------|
| 240.040.06M | 150 | 4.0 | 3.0 | 30 | 12 | | 15° | FLAT | 38,00 € |
| 240.050.06M | 150 | 5.0 | 3.0 | 30 | 12 | | 15° | FLAT | 44,00 € |
| 240.060.06M | 150 | 6.0 | 3.0 | 30 | 12 | | 15° | FLAT | 45,00 € |
| 240.040.07M | 180 | 4.0 | 3.0 | 30 | 18 | | 15° | FLAT | 47,00 € |
| 240.050.07M | 180 | 5.0 | 3.0 | 30 | 18 | | 15° | FLAT | 50,00 € |
| 240.060.07M | 180 | 6.0 | 3.0 | 30 | 18 | | 15° | FLAT | 54,00 € |
| S 240.04008 | 200 | 4.0 | 3.0 | 30 | 18 | | 15° | FLAT | 45,00 € |
| S 240.05008 | 200 | 5.0 | 3.0 | 30 | 18 | | 15° | FLAT | 50,00 € |
| S 240.06008 | 200 | 6.0 | 3.0 | 30 | 18 | | 15° | FLAT | 55,00 € |
| S 240.07008 | 200 | 7.0 | 5.0 | 30 | 18 | | 15° | FLAT | 60,00 € |
| S 240.08008 | 200 | 8.0 | 5.0 | 30 | 18 | | 15° | FLAT | 65,00 € |

*İstenilen ölçü üretim yapılmaktadır.

*Diğer ölçüler için lütfen iletişime geçin.

*Fiyatlarımıza KDV Dahil Değildir.



230.312.08M

DADO KANAL TESTERESİ (6-20 mm Arası Ayarlı)

Kanal Geniřlięi

| | 6mm | 7mm | 8mm | 9mm | 10mm | 11mm | 12mm | 13mm | 14mm | 15mm | 16mm | 17mm | 18mm | 19mm | 20mm |
|---|-----|-----|-----|-----|------|------|------|------|------|------|------|------|------|------|------|
| A Sol Bıçak (203 mm 1 Ad.) | ● | ● | ● | ● | ● | ● | ● | ● | ● | ● | ● | ● | ● | ● | ● |
| B Saę Bıçak (203 mm 1 Ad.) | ● | ● | ● | ● | ● | ● | ● | ● | ● | ● | ● | ● | ● | ● | ● |
| C Ara Bıçak (3.14 mm 3 Ad.) | 0 | 0 | 0 | 0 | 1 | 1 | 1 | 2 | 2 | 2 | 2 | 3 | 3 | 3 | 3 |
| D Kilit Ara Parça Pvc (1.6 mm 3 Ad.) | 0 | 0 | 1 | 1 | 0 | 1 | 1 | 0 | 1 | 1 | 2 | 0 | 1 | 2 | 2 |
| E PVC Pul (0.1 mm 5 Ad.) | 0 | 0 | 0 | 2 | 1 | 0 | 0 | 0 | 1 | 1 | 0 | 4 | 0 | 0 | 2 |
| F PVC Pul (0.2 mm 2 Ad.) | 0 | 1 | 2 | 2 | 1 | 1 | 2 | 1 | 0 | 1 | 1 | 2 | 1 | 2 | 2 |
| G Manyetik Pul (0.3 mm 1 Ad.) | 0 | 1 | 0 | 1 | 0 | 0 | 1 | 0 | 0 | 1 | 1 | 1 | 1 | 0 | 1 |
| H Manyetik Pul (0.5 mm 1 Ad.) | 0 | 1 | 0 | 1 | 1 | 0 | 1 | 1 | 0 | 1 | 0 | 1 | 1 | 0 | 1 |

| Order No. | D | K | P | d | Z | FT | α | β | Fiyat |
|-------------|-----|------|---|----|-------|----|------|-----------|----------|
| 230.312.08M | 203 | 6-20 | | 30 | 12-12 | | -12* | FTG + ATB | 220,00 € |

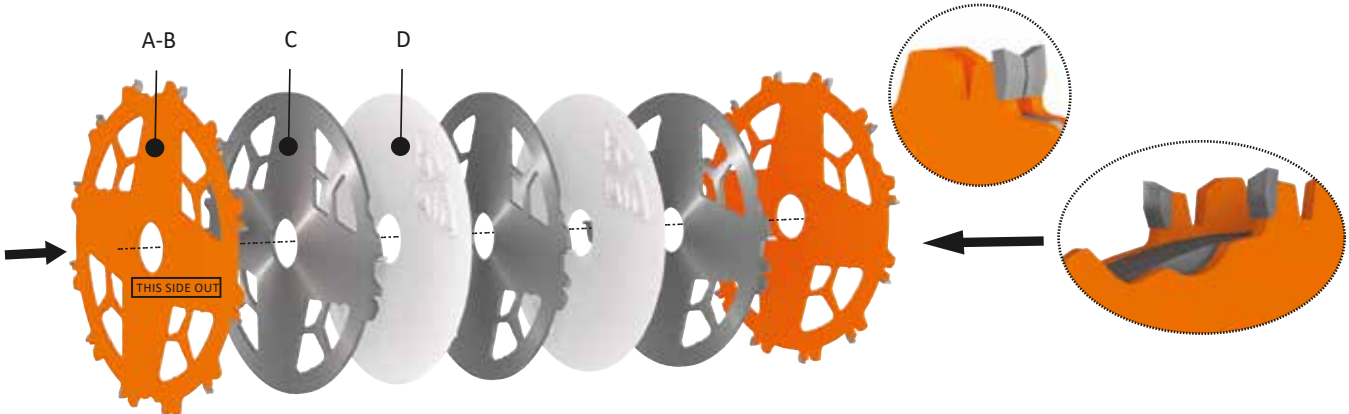
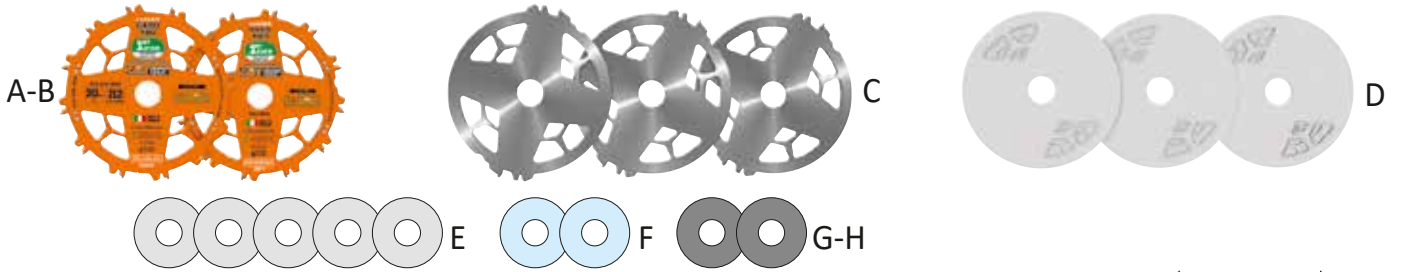

*Fiyatlarımıza KDV Dahil Deęildir. *Dięer ölçüler için lütfen iletiřime geçin.



DİA OLUKLU TESTERE (ÇİZİCİSİZ)



20X
UZUN ÖMÜR

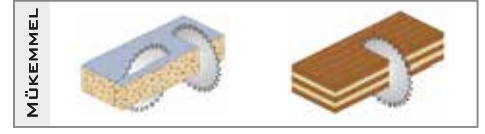
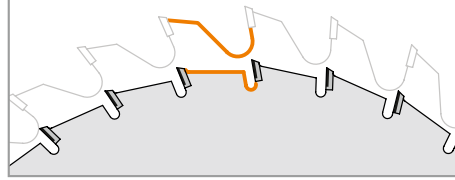
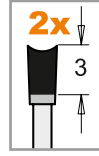

| Order No. | D | K | P | d | Z | FT | α | β | Fiyat |
|-------------|-----|-----|-----|----|----|--------|----------|---------|----------|
| 235.250.36M | 250 | 2.5 | 2.0 | 30 | 36 | COMBI3 | 10° | HR | 525,00 € |
| 235.300.44M | 300 | 2.5 | 2.0 | 30 | 44 | COMBI3 | 10° | HR | 600,00 € |



50X
UZUN ÖMÜR

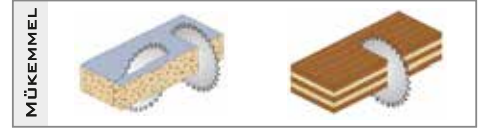
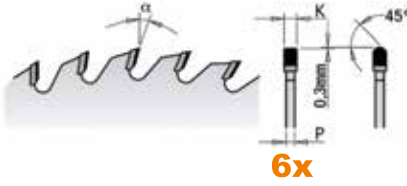
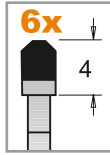

| Order No. | D | K | P | d | Z | FT | α | β | Fiyat |
|-------------|-----|-----|-----|----|----|--------|----------|---------|------------|
| 237.048.10M | 250 | 3.2 | 2.2 | 30 | 48 | COMBI3 | 10° | 45° TCG | 926,00 € |
| 237.060.12M | 300 | 3.2 | 2.2 | 30 | 60 | COMBI3 | 10° | 45° TCG | 1.125,00 € |
| 237.072.14M | 350 | 3.5 | 2.4 | 30 | 72 | COMBI3 | 15° | 45° TCG | 1.372,00 € |

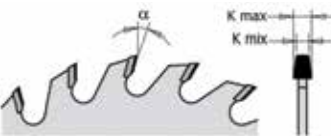
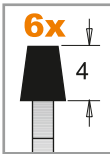

50X
UZUN ÖMÜR



DİA ÇİZİCİ TESTERE

| Order No. | D | K | P | d | Z | FT | α | β | Fiyat |
|-------------|-----|---------|---|----|----|----|----------|---------|----------|
| 238.120.20H | 120 | 3.1-3.7 | | 20 | 20 | | 5° | CON | 480,00 € |
| 238.125.20H | 125 | 3.1-3.7 | | 20 | 20 | | 5° | CON | 480,00 € |

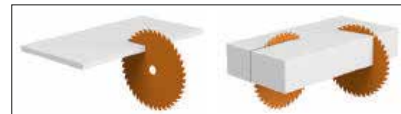
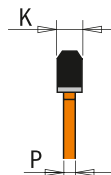
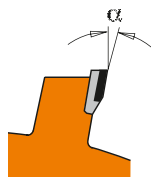

DİA ULTRA TESTERE (BETOPAN/ETERNIT/ CORIAN/FORMICA)

| Order No. | D | K | P | d | Z | FT | α | β | Fiyat |
|-------------|-----|-----|-----|----|----|--------|----------|---------|----------|
| 236.250.16M | 250 | 2.4 | 1.8 | 30 | 16 | COMBI3 | 12° | TCG | 210,00 € |

*Fiyatlarımıza KDV Dahil Değildir.

*Diğer ölçüler için lütfen iletişime geçin.



COMPACT DİA HOGGER

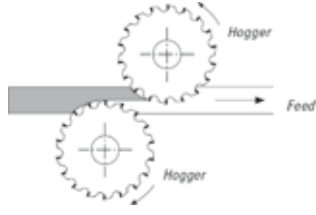

| Order No. | D | K | P | d | Z | FT | RH/LH | Fiyat |
|-----------|-----|----|---|----|----|----|-------|--------------------------------------|
| 003901L | 250 | 10 | | 80 | 24 | | LH | Fiyat bilgisi için irtibata geçiniz. |
| 003901R | 250 | 10 | | 80 | 24 | | RH | Fiyat bilgisi için irtibata geçiniz. |
| 003902L | 250 | 10 | | 80 | 36 | | LH | Fiyat bilgisi için irtibata geçiniz. |
| 003902R | 250 | 10 | | 80 | 36 | | RH | Fiyat bilgisi için irtibata geçiniz. |
| 003903L | 250 | 10 | | 80 | 48 | | LH | Fiyat bilgisi için irtibata geçiniz. |
| 003903R | 250 | 10 | | 80 | 48 | | RH | Fiyat bilgisi için irtibata geçiniz. |



DİA HOGGER

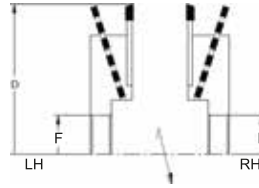
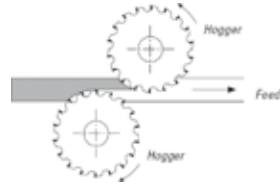

| Order No. | D | K | P | d | Z | FT | RH/LH | Fiyat |
|-------------|-----|----|---|--------|---------|----|-------|--------------------------------------|
| 0033.251.31 | 250 | 18 | | 35 DKN | 48F+6x4 | | LH | Fiyat bilgisi için irtibata geçiniz. |
| 0033.251.01 | 250 | 18 | | 35 DKN | 48F+6x4 | | RH | Fiyat bilgisi için irtibata geçiniz. |
| 0033.251.41 | 250 | 18 | | 35 DKN | 72F+6x4 | | LH | Fiyat bilgisi için irtibata geçiniz. |
| 0033.251.10 | 250 | 18 | | 35 DKN | 72F+6x4 | | RH | Fiyat bilgisi için irtibata geçiniz. |



SEGMENT DİA HOGGER

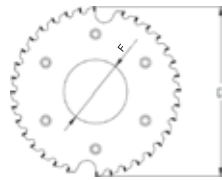

| Order No. | D | K | P | d | Z | FT | RH/LH | Fiyat |
|-------------|-----|-----|-----|-----|-----|----------|-------|--------------------------------------|
| 0032.250.08 | 250 | 4.0 | 2.8 | 80 | 48F | 6/10/200 | LH | Fiyat bilgisi için irtibata geçiniz. |
| 0032.250.09 | 250 | 4.0 | 2.8 | 80 | 48F | 6/10/200 | RH | Fiyat bilgisi için irtibata geçiniz. |
| 0032.250.80 | 250 | 4.0 | 2.8 | 80 | 72F | 6/10/200 | LH | Fiyat bilgisi için irtibata geçiniz. |
| 0032.251.80 | 250 | 4.0 | 2.8 | 80 | 72F | 6/10/200 | RH | Fiyat bilgisi için irtibata geçiniz. |
| 0032.255.41 | 250 | 4.0 | 2.8 | 100 | 54F | 6/10/200 | LH | Fiyat bilgisi için irtibata geçiniz. |
| 0032.256.41 | 250 | 4.0 | 2.8 | 100 | 54F | 6/10/200 | RH | Fiyat bilgisi için irtibata geçiniz. |
| 0032.257.41 | 250 | 4.0 | 2.8 | 80 | 60F | 6/10/200 | LH | Fiyat bilgisi için irtibata geçiniz. |
| 0032.258.41 | 250 | 4.0 | 2.8 | 80 | 60F | 6/10/200 | RH | Fiyat bilgisi için irtibata geçiniz. |

*Fiyatlarımıza KDV Dahil Değildir.

*Diğer ölçüler için lütfen iletişime geçin.

PANEL EBATLAMA TESTERELER **CMT** ORANGE TOOLS®





PANEL EBATLAMA ANA TESTERELER

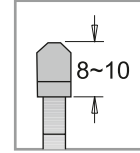
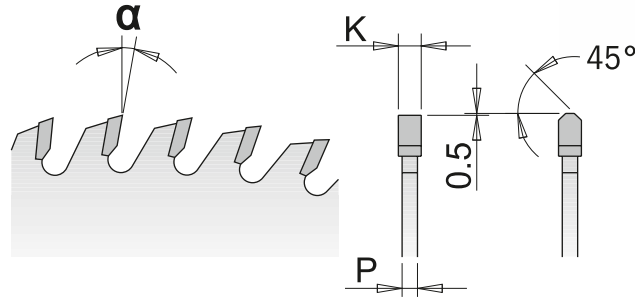

| Order No. | D | K | P | d | Z | PİN ⊕⊕⊕ | α | β | Fiyat |
|---------------|-----|-----|-----|-------|----|------------------------------|-----|-----|----------|
| 282.060.12M | 300 | 4.4 | 3.2 | 30 | 60 | COMBI3 | 16° | TCG | 135,00 € |
| 282.072.13J | 320 | 4.4 | 3.2 | 65/75 | 72 | (2/9/100+2/9/110) 3/7/100 | 16° | TCG | 145,00 € |
| 282.072.14M | 350 | 4.4 | 3.2 | 30 | 72 | COMBI3 | 16° | TCG | 155,00 € |
| 282.072.14T | 350 | 4.4 | 3.2 | 50 | 72 | 3/13/80 | 16° | TCG | 155,00 € |
| 282.072.14J2 | 355 | 4.4 | 3.2 | 65 | 72 | 2/9/100 + 2/9/110 | 16° | TCG | 160,00 € |
| 282.072.14W2 | 355 | 4.4 | 3.2 | 80 | 72 | 4/9/100 + 2/9/110 + 2/14/110 | 16° | TCG | 160,00 € |
| 282.072.15U2 | 380 | 4.4 | 3.2 | 60 | 72 | 2/14/100 | 16° | TCG | 180,00 € |
| 282.072.15W | 380 | 4.4 | 3.2 | 80 | 72 | COMBI5 | 16° | TCG | 180,00 € |
| 282.072.16M | 400 | 4.4 | 3.2 | 30 | 72 | 2/10/60 | 16° | TCG | 180,00 € |
| 282.072.16X | 400 | 4.4 | 3.2 | 72 | 72 | 4/15/105 | 16° | TCG | 180,00 € |
| 282.072.16W | 400 | 4.4 | 3.2 | 80 | 72 | COMBI5 | 16° | TCG | 180,00 € |
| Y282.072.17J | 430 | 4.4 | 3.2 | 65 | 72 | 2/9/100 + 2/9/110 | 16° | TCG | 200,00 € |
| 282.072.17X | 430 | 4.4 | 3.2 | 75 | 72 | 4/15/105 | 16° | TCG | 200,00 € |
| 282.072.17W2 | 430 | 4.4 | 3.2 | 80 | 72 | COMBI5 | 16° | TCG | 200,00 € |
| Y282.072.18M2 | 450 | 4.4 | 3.2 | 30 | 72 | 2/10/60+2/13/94 | 16° | TCG | 225,00 € |
| 282.072.15U | 380 | 4.8 | 3.5 | 60 | 72 | 2/14/100 | 16° | TCG | 200,00 € |
| 282.072.18U | 450 | 4.8 | 3.5 | 60 | 72 | COMBI7 | 16° | TCG | 220,00 € |
| 282.072.18W2 | 450 | 4.8 | 3.5 | 80 | 72 | COMBI5 | 16° | TCG | 220,00 € |

*Diğer ölçüler için lütfen iletişime geçin.

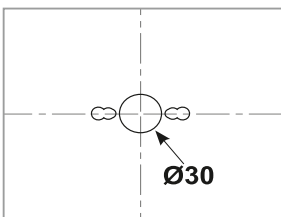

COMBI3
2/7/42mm
2/9/46,4mm
2/10/60mm

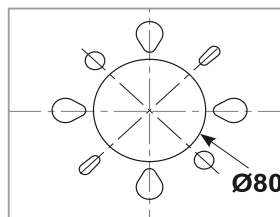

COMBI5
2/7/110mm
2/8,4/130mm
2/14/110mm
4/9/100mm
4/19/120mm
4/15/125mm

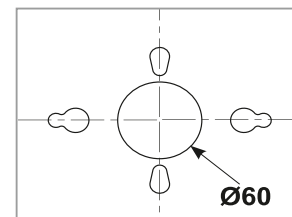

COMBI7
2/10/80mm
1/11/85mm
2/11/115mm
2/11/148mm
2/14/100mm
2/14/125mm
2/19/120mm

*Fiyatlarımıza KDV Dahil Değildir.

*Diğer ölçüler için lütfen iletişime geçin.

X TREME

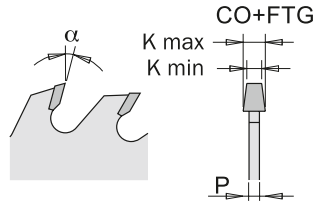
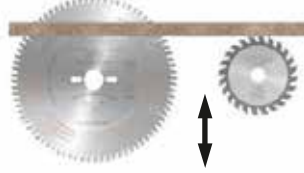

PANEL EBATLAMA ÇİZİCİ TESTERELER

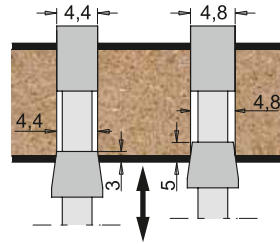

| Order No. | D | K | P | d | Z | PİN $\oplus\ominus$ | α | β | Fiyat |
|--------------|-----|---------|-----|----|----|---------------------|----------|---------|----------|
| 288.125.24H2 | 125 | 3.1-5.5 | 3.2 | 20 | 24 | | 10° | CO+FTG | 75,00 € |
| 288.125.24Q | 125 | 4.3-5.5 | 3.2 | 45 | 24 | | 10° | CO+FTG | 75,00 € |
| 288.150.36Y | 150 | 4.4-5.6 | 3.2 | 30 | 36 | | 10° | CO+FTG | 85,00 € |
| 288.160.36Q | 160 | 4.3-5.5 | 3.2 | 45 | 36 | 3/11/70 | 10° | CO+FTG | 100,00 € |
| 288.160.36O | 160 | 4.3-5.5 | 3.2 | 55 | 36 | 3/7/66 + 3/6/84 | 10° | CO+FTG | 100,00 € |
| 288.180.36M | 180 | 4.4-5.3 | 3.2 | 30 | 36 | | 10° | CO+FTG | 110,00 € |
| 288.180.44T | 180 | 4.3-5.5 | 3.2 | 50 | 44 | 3/13/80 | 10° | CO+FTG | 110,00 € |
| 288.200.36H | 200 | 4.4-5.3 | 3.2 | 20 | 36 | | 10° | CO+FTG | 110,00 € |
| 288.200.36J | 200 | 4.4-5.3 | 3.2 | 65 | 36 | 2/9/100 + 2/9/110 | 10° | CO+FTG | 110,00 € |
| 288.180.36Q | 180 | 4.8-5.6 | 3.5 | 45 | 36 | | 10° | CO+FTG | 110,00 € |
| 288.200.36Q | 200 | 4.7-6.0 | 3.5 | 45 | 36 | | 10° | CO+FTG | 110,00 € |

*Diğer ölçüler için lütfen iletişime geçin.

| MAKİNA MODEL | ANA TESTERE ÇAPLARI | ELMAS KALINLIĞI | GÖBEK DELİĞİ | PİN DELİĞİ |
|---|-------------------------|-----------------|--------------|--------------------------------|
| GABBIANI ANA TESTERE | 350+355+380+400+420+450 | 4,4 | 80 | 2/7/110 + 2/14/110 |
| GABBIANI ÇİZİCİ TESTERE | 160+200 | 4,4 | 55/80 | 3/7/66+3/6/84+ 2/14/110 |
| GİBEN ANA TESTERE | 350+380+400+430 | 4,4 | 50 + 75 | 4/13/80 + 4/15/105 + (2/7/110) |
| GİBEN ÇİZİCİ TESTERE | 125+160+180+200+215 | 4,4 | 45 + 50 | 3/13/70 + 3/13/80 + (2/7/80) |
| BIESSE-SELCO ANA TESTERE | 355+400+430+450 | 4,4 - 4,8 | 65 + 80 | 2/9/110 + 4/19/120 + 4/11/130 |
| BIESSE-SELCO ÇİZİCİ TESTERE | 200 | 4,4 - 4,8 | 65 | 2/9/100 + 2/9/110 |
| HOMAG-HOLZMA ANA TESTERE | 350+380+450 | 4,4 - 4,8 | 60 | 2/14/100 + 2/14/125 |
| HOMAG-HOLZMA ÇİZİCİ TESTERE | 180+200 | 4,4 - 4,8 | 45 | 0 + (2/10/60) |
| SCM, MAYER, HOLZHER, CASADEI ANA TESTERE | 300+320+350+355 | 4,4 | 30 | 2/10/60 + 2/7/42 (2/14/110) |
| SCM, MAYER, HOLZHER, CASADEI ÇİZİCİ TESTERE | 125+150+180+200 | 4,4 | 30 | 0 |
| TURANLAR ANA TESTERE | 300+320+350+400+430+450 | 4,4 | 30 + 80 | 2/10/60 + 2/15/125 + (2/13/94) |
| TURANLAR ÇİZİCİ TESTERE | 150+180+200 | 4,4 | 30 + 65 | 02/10/60 + (2/11/110) |
| TÖRK ANA TESTERE | 320 | 4,4 | 75 | 3/7/100 |
| TÖRK ÇİZİCİ TESTERE | 160 | 4,4 | 55 | 3/7/66+3/6/84 |

*Diğer ölçüler için lütfen iletişime geçin.

*Fiyatlarımıza KDV Dahil Değildir.



PANEL EBATLAMA TESTERELER ÖLÇÜ BELİRLEME ŞABLONU

2 DELİKLİ

PİN DELİK ÇAPI :
GÖBEK DELİK ÇAPI :
PİN DELİK AKS ARASI :

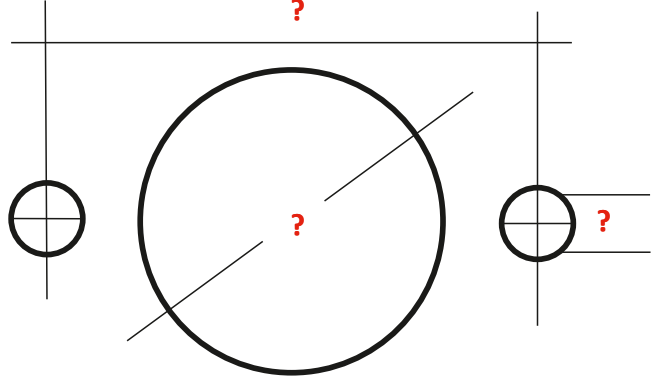

3 DELİKLİ

PİN DELİK ÇAPI :
GÖBEK DELİK ÇAPI :
PİN DELİK AKS ARASI :

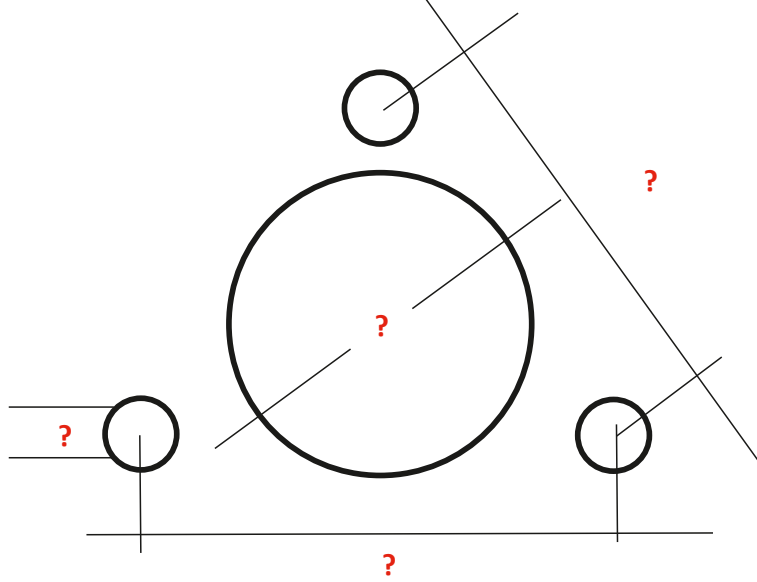

4 DELİKLİ

PİN DELİK ÇAPI :
GÖBEK DELİK ÇAPI :
PİN DELİK AKS ARASI :

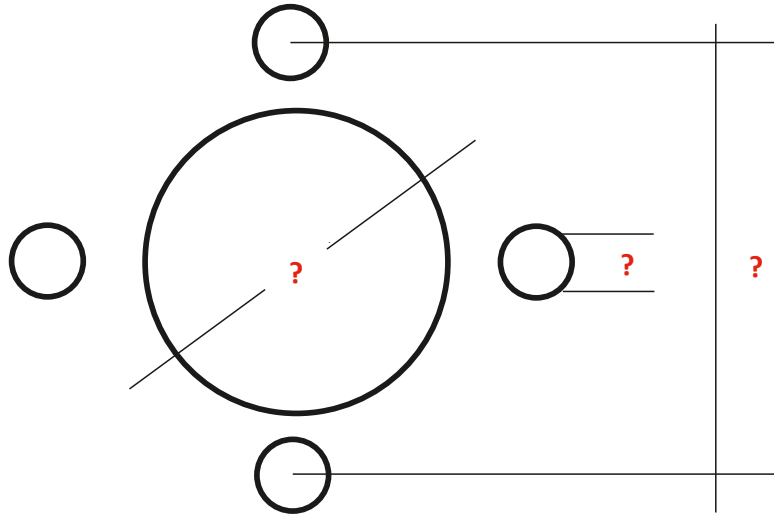

MATKAP UÇLARI

CMT ORANGE
TOOLS®



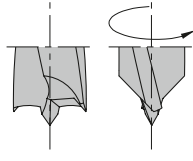
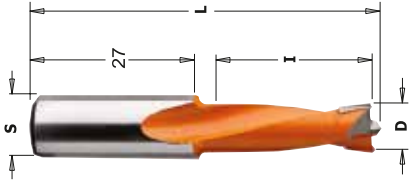

YARIM DELİK MATKAP UÇLARI (KISA)

| Order No. LH | Order No. RH | D | I | L | S | Fiyat |
|--------------|--------------|----|----|------|-------|---------|
| 310.040.12 | 310.040.11 | 4 | 27 | 57.5 | 10x27 | 12,50 € |
| 310.050.12 | 310.050.11 | 5 | 27 | 57.5 | 10x27 | 10,00 € |
| 310.060.12 | 310.060.11 | 6 | 27 | 57.5 | 10x27 | 10,30 € |
| 310.070.12 | 310.070.11 | 7 | 27 | 57.5 | 10x27 | 11,40 € |
| 310.080.12 | 310.080.11 | 8 | 27 | 57.5 | 10x27 | 11,00 € |
| 310.090.12 | 310.090.11 | 9 | 27 | 57.5 | 10x27 | 12,60 € |
| 310.100.12 | 310.100.11 | 10 | 27 | 57.5 | 10x27 | 12,60 € |
| 310.110.12 | 310.110.11 | 11 | 27 | 57.5 | 10x27 | 13,60 € |
| 310.120.12 | 310.120.11 | 12 | 27 | 57.5 | 10x27 | 13,60 € |

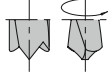
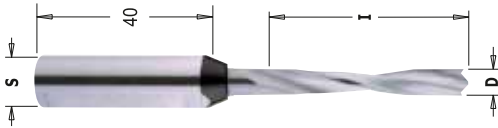

YARIM DELİK MATKAP UÇLARI (İNCE/UZUN)

| Order No. LH | Order No. RH | D | I | L | S | Fiyat |
|--------------|--------------|-----|----|----|-------|---------|
| 311.030.22 | 311.030.21 | 3 | 18 | 70 | 10x40 | 16,50 € |
| 311.035.22 | 311.035.21 | 3.5 | 18 | 70 | 10x40 | 18,00 € |
| 311.040.22 | 311.040.21 | 4 | 27 | 70 | 10x29 | 18,00 € |
| 311.050.22 | 311.050.21 | 5 | 30 | 70 | 10x28 | 19,00 € |

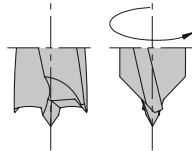
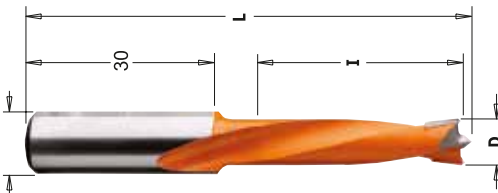

YARIM DELİK MATKAP UÇLARI (UZUN)

| Order No. LH | Order No. RH | D | I | L | S | Fiyat |
|--------------|--------------|----|----|----|-------|---------|
| 311.040.12 | 311.040.11 | 4 | 35 | 70 | 10x30 | 13,00 € |
| 311.050.12 | 311.050.11 | 5 | 35 | 70 | 10x30 | 10,50 € |
| 311.060.12 | 311.060.11 | 6 | 35 | 70 | 10x30 | 11,00 € |
| 311.070.12 | 311.070.11 | 7 | 35 | 70 | 10x30 | 11,80 € |
| 311.080.12 | 311.080.11 | 8 | 35 | 70 | 10x30 | 11,50 € |
| 311.090.12 | 311.090.11 | 9 | 35 | 70 | 10x30 | 13,20 € |
| 311.100.12 | 311.100.11 | 10 | 35 | 70 | 10x30 | 13,20 € |
| 311.110.12 | 311.110.11 | 11 | 35 | 70 | 10x30 | 14,00 € |
| 311.120.12 | 311.120.11 | 12 | 35 | 70 | 10x30 | 14,00 € |

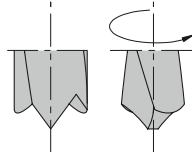
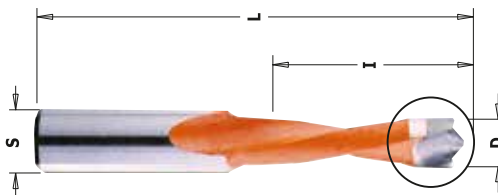

YARIM DELİK MATKAP UÇLARI (UZUN)

| Order No. LH | Order No. RH | D | I | L | S | Fiyat |
|--------------|--------------|---|----|----|-------|---------|
| 311.080.42 | 311.080.41 | 8 | 35 | 70 | 10x30 | 13,00 € |

*Fiyatlarımıza KDV Dahil Değildir.

*Diğer ölçüler için lütfen iletişime geçin.

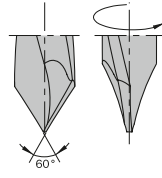
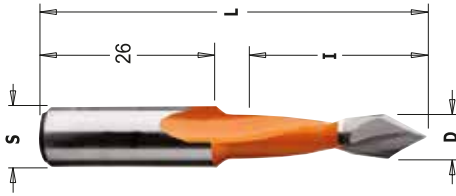

TAM DELİK MATKAP UÇLARI (KISA)

| Order No. LH | Order No. RH | D | I | L | S | Fiyat |
|--------------|--------------|----|----|------|-------|---------|
| 313.050.12 | 313.050.11 | 5 | 27 | 57.5 | 10x26 | 13,20 € |
| 313.080.12 | 313.080.11 | 8 | 27 | 57.5 | 10x26 | 14,50 € |
| 313.100.12 | 313.100.11 | 10 | 27 | 57.5 | 10x26 | 16,00 € |

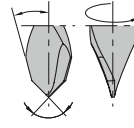
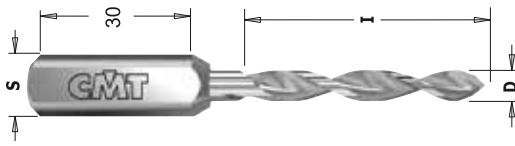

TAM DELİK MATKAP UÇLARI (İNCE/UZUN)

| Order No. LH | Order No. RH | D | I | L | S | Fiyat |
|--------------|--------------|---|----|----|-------|---------|
| 314.030.22 | 314.030.21 | 3 | 27 | 70 | 10x30 | 17,50 € |
| 314.040.22 | 314.040.21 | 4 | 35 | 70 | 10x26 | 18,50 € |
| 314.050.22 | 314.050.21 | 5 | 35 | 70 | 10x26 | 19,50 € |

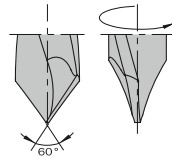
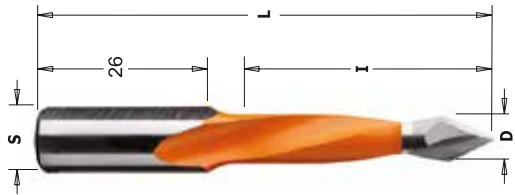

TAM DELİK MATKAP UÇLARI (UZUN)

| Order No. LH | Order No. RH | D | I | L | S | Fiyat |
|--------------|--------------|----|----|----|-------|---------|
| 314.040.12 | 314.040.11 | 4 | 30 | 70 | 10x26 | 16,30 € |
| 314.050.12 | 314.050.11 | 5 | 35 | 70 | 10x26 | 14,00 € |
| 314.060.12 | 314.060.11 | 6 | 35 | 70 | 10x26 | 14,50 € |
| 314.070.12 | 314.070.11 | 7 | 35 | 70 | 10x26 | 16,00 € |
| 314.080.12 | 314.080.11 | 8 | 35 | 70 | 10x26 | 16,50 € |
| 314.090.12 | 314.090.11 | 9 | 35 | 70 | 10x26 | 16,50 € |
| 314.100.12 | 314.100.11 | 10 | 35 | 70 | 10x26 | 16,50 € |
| 314.120.12 | 314.120.11 | 12 | 35 | 70 | 10x26 | 19,00 € |

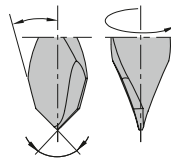
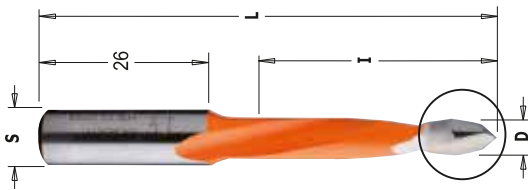

TAM DELİK MATKAP UÇLARI (UZUN)

| Order No. LH | Order No. RH | D | I | L | S | Fiyat |
|--------------|--------------|---|----|----|-------|---------|
| 314.080.42 | 314.080.41 | 8 | 35 | 70 | 10x26 | 18,00 € |

*Fiyatlarımıza KDV Dahil Değildir.

*Diğer ölçüler için lütfen iletişime geçin.

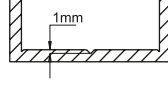
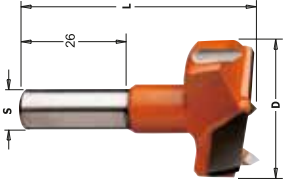

MENTEŞE MATKAP UÇLARI (KISA)

| Order No. LH | Order No. RH | D | I | L | S | Fiyat |
|--------------|--------------|----|---|------|-------|---------|
| 317.150.12 | 317.150.11 | 15 | | 57.5 | 10x26 | 20,50 € |
| 317.160.12 | 317.160.11 | 16 | | 57.5 | 10x26 | 20,50 € |
| 317.180.12 | 317.180.11 | 18 | | 57.5 | 10x26 | 21,40 € |
| 317.200.12 | 317.200.11 | 20 | | 57.5 | 10x26 | 21,40 € |
| 317.250.12 | 317.250.11 | 25 | | 57.5 | 10x26 | 24,30 € |
| 317.260.12 | 317.260.11 | 26 | | 57.5 | 10x26 | 24,30 € |
| 317.300.12 | 317.300.11 | 30 | | 57.5 | 10x26 | 26,00 € |
| 317.350.12 | 317.350.11 | 35 | | 57.5 | 10x26 | 26,00 € |

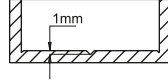
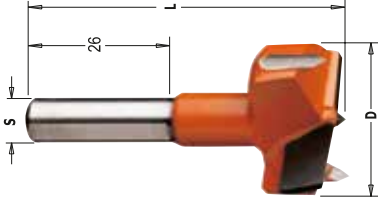

MENTEŞE MATKAP UÇLARI (UZUN)

| Order No. LH | Order No. RH | D | I | L | S | Fiyat |
|--------------|--------------|----|---|----|-------|---------|
| 369.150.12 | 369.150.11 | 15 | | 70 | 10x26 | 22,00 € |
| 369.160.12 | 369.160.11 | 16 | | 70 | 10x26 | 23,00 € |
| 369.180.12 | 369.180.11 | 18 | | 70 | 10x26 | 24,00 € |
| 369.200.12 | 369.200.11 | 20 | | 70 | 10x26 | 24,00 € |
| 369.220.12 | 369.220.11 | 22 | | 70 | 10x26 | 25,00 € |
| 369.250.12 | 369.250.11 | 25 | | 70 | 10x26 | 25,00 € |
| 369.260.12 | 369.260.11 | 26 | | 70 | 10x26 | 26,00 € |
| 369.300.12 | 369.300.11 | 30 | | 70 | 10x26 | 28,00 € |
| 369.350.12 | 369.350.11 | 35 | | 70 | 10x26 | 28,50 € |

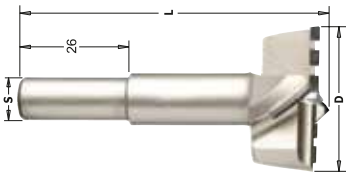

20X
UZUN ÖMÜR

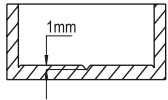

DIA MENTEŞE MATKAP UÇLARI (KISA & UZUN)

| Order No. LH | Order No. RH | D | I | L | S | Fiyat |
|--------------|--------------|----|---|------|-------|----------|
| 317.150.62 | 317.150.61 | 15 | | 57,5 | 10x26 | 317,00 € |
| 317.350.62 | 317.350.61 | 35 | | 57,5 | 10x26 | 357,00 € |

| Order No. LH | Order No. RH | D | I | L | S | Fiyat |
|--------------|--------------|----|---|----|-------|----------|
| 369.150.62 | 369.150.61 | 15 | | 70 | 10x26 | 317,00 € |
| 369.350.62 | 369.350.61 | 35 | | 70 | 10x26 | 357,00 € |

*Fiyatlarımıza KDV Dahil Değildir.

*Diğer ölçüler için lütfen iletişime geçin.



HAVŞALI DÜBEL MATKAP UÇLARI (KISA/UZUN)

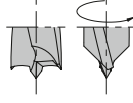
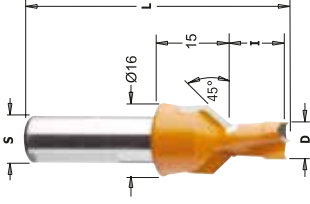

| Order No. LH | Order No. RH | D | I | L | S | Fiyat |
|--------------|--------------|---|----|------|----|---------|
| 376.080.12 | 376.080.11 | 8 | 12 | 57.5 | 10 | 20,00 € |
| 376.081.12 | 376.081.11 | 8 | 15 | 57.5 | 10 | 20,00 € |
| 376.082.12 | 376.082.11 | 8 | 20 | 57.5 | 10 | 20,00 € |

| Order No. LH | Order No. RH | D | I | L | S | Fiyat |
|--------------|--------------|---|----|----|----|---------|
| 377.080.12 | 377.080.11 | 8 | 12 | 70 | 10 | 20,00 € |
| 377.081.12 | 377.081.11 | 8 | 15 | 70 | 10 | 20,00 € |
| 377.082.12 | 377.082.11 | 8 | 20 | 70 | 10 | 20,00 € |

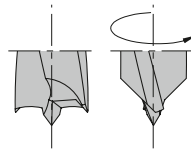
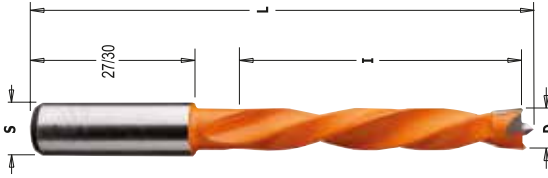

YARIM DELİK MATKAP UÇLARI (UZUN 4 HELİSLİ)

| Order No. LH | Order No. RH | D | I | L | S | Fiyat |
|--------------|--------------|----|----|----|-------|---------|
| 373.080.12 | 373.080.11 | 8 | 50 | 85 | 10x27 | 15,00 € |
| 373.100.12 | 373.100.11 | 10 | 50 | 85 | 10x27 | 16,50 € |
| 373.120.12 | 373.120.11 | 12 | 50 | 85 | 10x27 | 18,50 € |

| Order No. LH | Order No. RH | D | I | L | S | Fiyat |
|--------------|--------------|----|----|-----|-------|---------|
| 372.080.12 | 372.080.11 | 8 | 65 | 105 | 10x30 | 17,00 € |
| 372.100.12 | 372.100.11 | 10 | 65 | 105 | 10x30 | 19,00 € |
| 372.120.12 | 372.120.11 | 12 | 65 | 105 | 10x30 | 21,00 € |

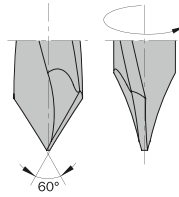
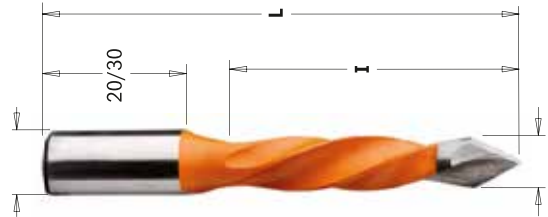

TAM DELİK MATKAP UÇLARI (UZUN 4 HELİSLİ)

| Order No. LH | Order No. RH | D | I | L | S | Fiyat |
|--------------|--------------|----|----|-----|-------|---------|
| 381.050.11 | 381.050.12 | 5 | 70 | 115 | 10X30 | 21,00 € |
| 381.080.11 | 381.080.12 | 8 | 70 | 115 | 10X30 | 22,00 € |
| 381.100.11 | 381.100.12 | 10 | 70 | 115 | 10X30 | 23,00 € |

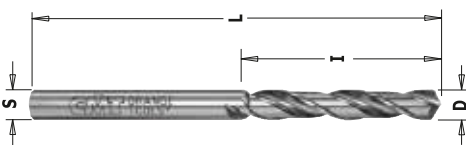

SOLID HM MATKAP UÇLARI

| Order No. LH | Order No. RH | D | I | L | S | Fiyat |
|--------------|--------------|-----|----|----|-----|---------|
| 363.025.12 | 363.025.11 | 2.5 | 27 | 55 | 2.5 | 9,00 € |
| 363.030.12 | 363.030.11 | 3 | 27 | 55 | 3 | 10,00 € |
| 363.035.12 | 363.035.11 | 3.5 | 27 | 55 | 3.5 | 12,00 € |

*Diğer ölçüler için lütfen iletişime geçin.

*Fiyatlarımıza KDV Dahil Değildir.

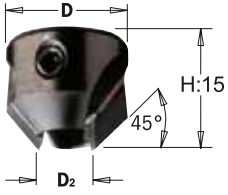

HAVŞALAR

| Order No. LH | Order No. RH | D ₂ | D | H | Açı | Fiyat |
|--------------|--------------|----------------|----|----|-----|---------|
| 316.040.12 | 316.040.11 | 4 | 16 | 15 | 45° | 19,00 € |
| 316.050.12 | 316.050.11 | 5 | 16 | 15 | 45° | 19,00 € |
| 316.060.12 | 316.060.11 | 6 | 16 | 15 | 45° | 19,00 € |
| 316.070.12 | 316.070.11 | 7 | 16 | 15 | 45° | 19,00 € |
| 316.080.12 | 316.080.11 | 8 | 18 | 15 | 45° | 19,00 € |
| 316.090.12 | 316.090.11 | 9 | 18 | 15 | 45° | 19,00 € |
| 316.100.12 | 316.100.11 | 10 | 20 | 15 | 45° | 19,00 € |
| 316.120.12 | 316.120.11 | 12 | 20 | 15 | 45° | 19,00 € |

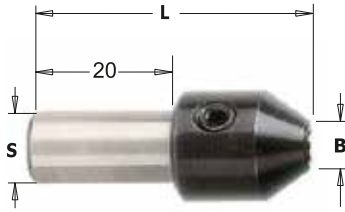

SOLID HM MATKAP UCU ADAPTÖRÜ

| Order No. | B | L | S | Fiyat |
|------------|-----|----|-------|---------|
| 364.025.00 | 2,5 | 38 | 10x20 | 10,00 € |
| 364.030.00 | 3 | 38 | 10x20 | 10,00 € |
| 364.035.00 | 3,5 | 38 | 10x20 | 10,00 € |

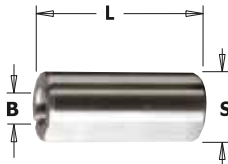

MATKAP UCU KOVANI

| Order No. | B | L | S | Fiyat |
|------------|-----|----|----|--------|
| 365.025.00 | 2,5 | 23 | 10 | 9,00 € |
| 365.030.00 | 3 | 23 | 10 | 9,00 € |
| 365.035.00 | 3,5 | 23 | 10 | 9,00 € |



M10 ŞAFTLI DÜBEL MATKAP UÇLARI

*Diğer ölçüler için lütfen iletişime geçin.

| Order No. LH | Order No. RH | D | I | LB | L | S | Fiyat |
|--------------|--------------|----|----|----|----|------------|---------|
| 339.050.12 | 339.050.11 | 5 | 40 | 55 | 70 | M10 (11+4) | 27,50 € |
| 339.080.12 | 339.080.11 | 8 | 40 | 55 | 70 | M10 (11+4) | 28,50 € |
| 339.100.12 | 339.100.11 | 10 | 40 | 55 | 70 | M10 (11+4) | 28,50 € |

*Fiyatlarımıza KDV Dahil Değildir.

*Diğer ölçüler için lütfen iletişime geçin.

DELİK GRUBU ADAPTÖRLERİ



| Order No. | B | d | D | H | Fiyat |
|------------|----|------|----|----|---------|
| 360.101.00 | 10 | 17.5 | 18 | 42 | 16,00 € |

Vitap

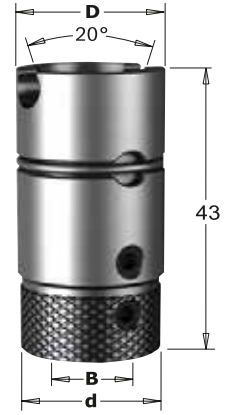

| Order No. | B | d | D | H | Fiyat |
|------------|----|------|----|----|---------|
| 360.201.00 | 10 | 19.5 | 20 | 43 | 20,00 € |

Morbidelli



| Order No. | B | d | D | H | Fiyat |
|------------|----|------|----|----|---------|
| 360.301.00 | 10 | 19.5 | 20 | 40 | 20,00 € |

Masterwood, Maggi, Griggio



| Order No. RH | Order No. LH | B | d | D | H | Fiyat |
|--------------|--------------|----|----|----|----|---------|
| 360.001.01 | 360.001.02 | 10 | 20 | 15 | 40 | 16,00 € |

Biesse



| Order No. RH | Order No. LH | B | D | S | H | Fiyat |
|--------------|--------------|----|------|------|----|--------|
| 358.000.01 | 358.000.02 | 10 | 19.5 | M8/9 | 40 | 8,00 € |

Masterwood, Morbidelli

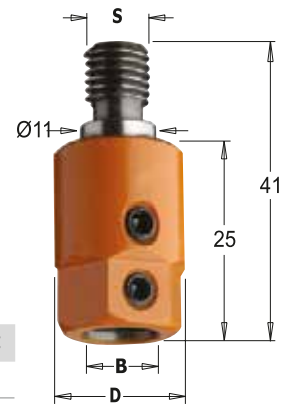

| Order No. RH | Order No. LH | B | D | S | H | Fiyat |
|--------------|--------------|----|------|--------|----|--------|
| 305.000.01 | 305.000.02 | 10 | 19.5 | M10/11 | 41 | 8,00 € |

Biesse, Masterwood, Morbidelli, Vitap, Weeke

*Diğer ölçüler için lütfen iletişime geçin.

*Fiyatlarımıza KDV Dahil Değildir.

CNC ADAPTÖRLER

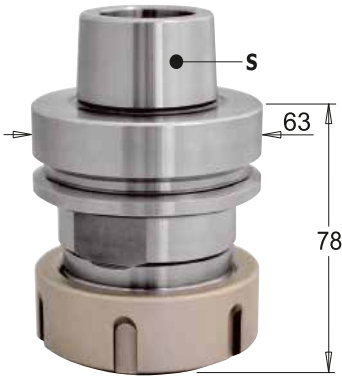

HSK-63F ER40

| Order No. RH | Fiyat |
|--------------|---------|
| 183.310.01 | 85,00 € |



HSK-63F ER32

| Order No. RH | Fiyat |
|--------------|---------|
| 183.300.01 | 80,00 € |



ISO30 ER40

| Order No. RH | Fiyat |
|--------------|---------|
| 183.201.01 | 85,00 € |

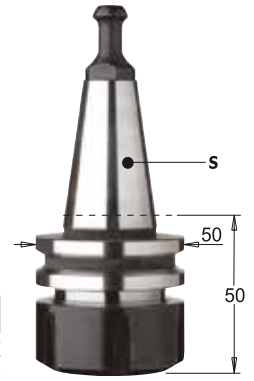

ISO30 ER32

| Order No. RH | Fiyat |
|--------------|---------|
| 183.200.01 | 76,00 € |



184 - ER40

| Order No. | Fiyat |
|------------|---------|
| 184.002.00 | 14,00 € |

4mm - 25mm'ye kadar.

184 - ER32

| Order No. | Fiyat |
|------------|---------|
| 184.000.00 | 13,00 € |

3mm - 20mm'ye kadar.



184 - ER25

| Order No. | Fiyat |
|------------|---------|
| 184.000.25 | 11,00 € |

3mm - 16mm'ye kadar.

184 - ER20

| Order No. | Fiyat |
|------------|---------|
| 184.000.20 | 11,00 € |

2mm - 12mm'ye kadar.

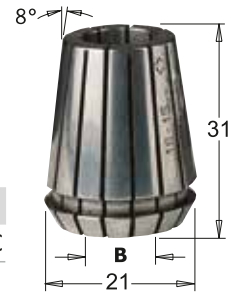

*Fiyatlarımıza KDV Dahil Değildir.

*Diğer ölçüler için lütfen iletişime geçin.



CNC KİNETİK TOZ EMİCİ

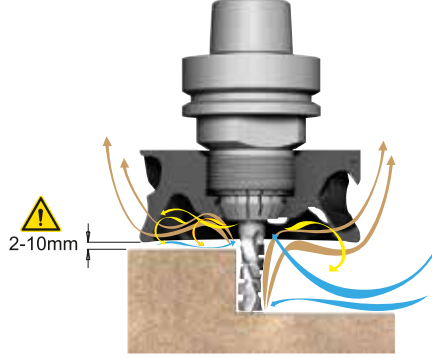

| Order No. | D | Fiyat |
|--------------|-----|----------|
| 992.101.ER32 | 100 | 400,00 € |
| 992.101.ER40 | 100 | 400,00 € |



VIDEO İZLE



*Diğer ölçüler için lütfen iletişime geçin.

*Fiyatlarımıza KDV Dahil Değildir.

ADAPTÖR SOMUNU



ER 40

| Order No. | Fiyat |
|------------|---------|
| 992.383.01 | 15,00 € |

ER 32

| Order No. | Fiyat |
|------------|---------|
| 992.183.01 | 15,00 € |



MONTAJ DESTEĞİ

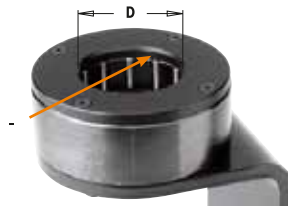

| Order No. | D | Fiyat |
|-----------|----|----------|
| 183-HSK | 63 | 255,00 € |
| 183-ISO | 50 | 255,00 € |

ANAHTAR



| Order No. | | Fiyat |
|------------|-------|---------|
| 991.183.00 | ER 32 | 21,00 € |
| 991.184.00 | ER 40 | 23,00 € |

FREZELER

CMT ORANGE
TOOLS®



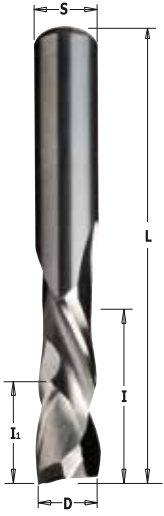

HWM

NEGATİF / POZİTİF ALT ÜST HASSAS KESİM

| Order No. | D mm | I mm | I ₁ mm | L mm | S mm | Z | Fiyat |
|------------|------|------|-------------------|------|------|-----|----------|
| 190.040.11 | 4 | 15 | 7 | 50 | 4 | 1+1 | 22,00 € |
| 190.050.11 | 5 | 22 | 8 | 60 | 5 | 1+1 | 28,00 € |
| 190.060.11 | 6 | 22 | 8 | 60 | 6 | 1+1 | 30,00 € |
| 190.080.11 | 8 | 32 | 7 | 80 | 8 | 2+2 | 57,00 € |
| 190.100.11 | 10 | 32 | 7 | 80 | 10 | 2+2 | 81,00 € |
| 190.101.11 | 10 | 42 | 7 | 90 | 10 | 2+2 | 85,00 € |
| 190.120.11 | 12 | 42 | 7 | 90 | 12 | 2+2 | 115,00 € |
| 190.121.11 | 12 | 52 | 7 | 100 | 12 | 2+2 | 120,00 € |
| 190.160.11 | 16 | 55 | 24 | 110 | 16 | 2+2 | 198,00 € |
| 190.180.11 | 18 | 55 | 30 | 110 | 18 | 2+2 | 265,00 € |

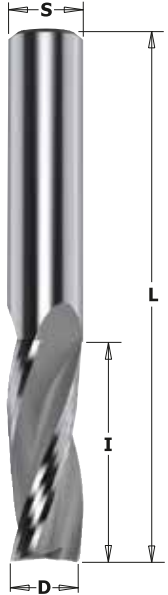

HWM

HASSAS KESİM

| Order No. | D mm | I mm | L mm | S mm | Z | Fiyat |
|------------|------|------|------|------|---|----------|
| 193.081.11 | 8 | 32 | 80 | 8 | 3 | 42,00 € |
| 193.100.11 | 10 | 32 | 80 | 10 | 3 | 63,00 € |
| 193.101.11 | 10 | 42 | 90 | 10 | 3 | 77,00 € |
| 193.120.11 | 12 | 35 | 83 | 12 | 3 | 86,00 € |
| 193.121.11 | 12 | 42 | 90 | 12 | 3 | 98,00 € |
| 193.122.11 | 12 | 52 | 100 | 12 | 3 | 103,00 € |
| 193.140.11 | 14 | 58 | 110 | 14 | 3 | 138,00 € |
| 193.160.11 | 16 | 55 | 110 | 16 | 3 | 175,00 € |
| 193.161.11 | 16 | 35 | 90 | 16 | 3 | 145,00 € |
| 193.165.11 | 16 | 72 | 120 | 16 | 3 | 188,00 € |
| 193.180.11 | 18 | 55 | 110 | 18 | 3 | 222,00 € |
| 193.200.11 | 20 | 60 | 120 | 20 | 3 | 250,00 € |
| 193.201.11 | 20 | 70 | 120 | 20 | 3 | 258,00 € |

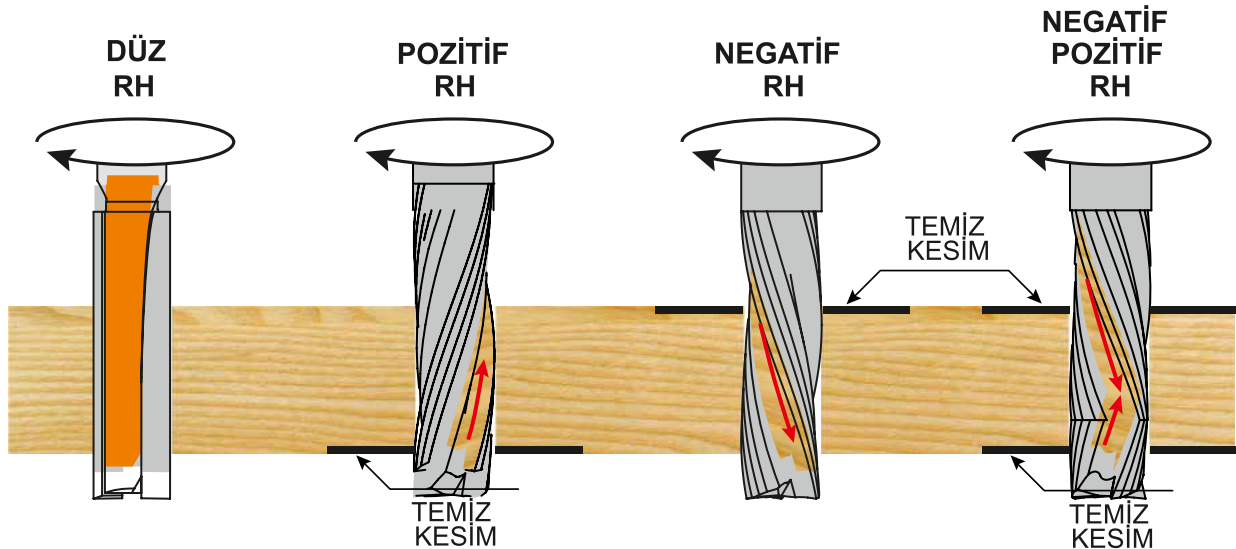

*Fiyatlarımıza KDV Dahil Değildir.

*Diğer ölçüler için lütfen iletişime geçin.



HWM

PVC & PLEKSİ KESİM

| Order No. | D mm | I mm | L mm | S mm | Z | Fiyat |
|------------|------|------|------|------|---|---------|
| 198.030.11 | 3 | 12 | 50 | 3 | 1 | 20,00 € |
| 198.040.11 | 4 | 15 | 50 | 4 | 1 | 22,00 € |
| 198.050.11 | 5 | 17 | 50 | 5 | 1 | 27,00 € |
| 198.060.11 | 6 | 22 | 60 | 6 | 1 | 34,00 € |
| 198.080.11 | 8 | 22 | 70 | 8 | 1 | 38,00 € |
| 198.081.11 | 8 | 32 | 80 | 8 | 1 | 40,00 € |
| 198.100.11 | 10 | 32 | 70 | 10 | 1 | 58,00 € |
| 198.101.11 | 10 | 42 | 80 | 10 | 1 | 60,00 € |
| 198.102.11 | 10 | 52 | 90 | 12 | 1 | 66,00 € |
| 198.120.11 | 12 | 32 | 83 | 10 | 1 | 81,00 € |



HWM

2D / 3D KESİM

| Order No. | D mm | R mm | A | I mm | L mm | S mm | Z | Fiyat |
|-------------|------|------|------|------|-------|------|---|----------|
| 152.060.082 | 0,8 | 0,4 | 5,5° | 25 | 70 | 6 | 3 | 38,00 € |
| 152.064.082 | 0,8 | 0,4 | 6,2° | 25,4 | 76,2 | 6,35 | 3 | 38,00 € |
| 152.060.162 | 1,6 | 0,8 | 4,5° | 25 | 70 | 6 | 3 | 38,00 € |
| 152.064.162 | 1,6 | 0,8 | 5,4° | 25,4 | 76,2 | 6,35 | 3 | 38,00 € |
| 152.080.163 | 1,6 | 0,8 | 5,5° | 30 | 80 | 8 | 3 | 42,00 € |
| 152.120.208 | 2 | 1 | 3° | 80 | 120 | 12 | 2 | 122,00 € |
| 152.060.323 | 3,2 | 1,6 | 2,5° | 30 | 70 | 6 | 3 | 40,00 € |
| 152.064.322 | 3,2 | 1,6 | 3,6° | 25,4 | 76,2 | 6,35 | 3 | 40,00 € |
| 152.080.325 | 3,2 | 1,6 | 2,5° | 50 | 90 | 8 | 3 | 54,00 € |
| 152.120.605 | 6 | 3 | 3° | 50 | 100 | 12 | 2 | 95,00 € |
| 152.127.635 | 6,4 | 3,2 | 3° | 50,8 | 101,6 | 12,7 | 2 | 115,00 € |

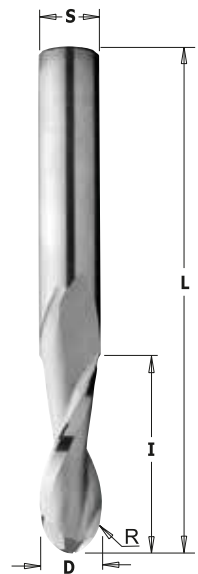

HWM

KÜRE KESİM

| Order No. | D mm | R mm | I mm | L mm | S mm | Z | Fiyat |
|------------|------|------|------|------|------|---|----------|
| 199.060.11 | 6 | 3 | 27 | 70 | 6 | 2 | 33,00 € |
| 199.081.11 | 8 | 4 | 32 | 80 | 8 | 2 | 39,00 € |
| 199.100.11 | 10 | 5 | 32 | 80 | 10 | 2 | 62,00 € |
| 199.120.11 | 12 | 6 | 35 | 80 | 12 | 2 | 85,00 € |
| 199.160.11 | 16 | 8 | 55 | 110 | 16 | 2 | 165,00 € |

HWM Karbür Elmas.

*Diğer ölçüler için lütfen iletişime geçin.

*Fiyatlarımıza KDV Dahil Değildir.

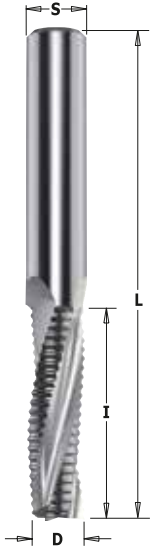

HWM

KABA TALAŞ KESİM

| Order No. | D mm | I mm | L mm | S mm | Z | Fiyat |
|------------|------|------|------|------|---|----------|
| 195.081.11 | 8 | 32 | 80 | 8 | 3 | 46,00 € |
| 195.082.11 | 8 | 42 | 90 | 8 | 3 | 57,00 € |
| 195.100.11 | 10 | 32 | 80 | 10 | 3 | 67,00 € |
| 195.101.11 | 10 | 42 | 90 | 10 | 3 | 82,00 € |
| 195.120.11 | 12 | 35 | 83 | 12 | 3 | 90,00 € |
| 195.121.11 | 12 | 42 | 90 | 12 | 3 | 103,00 € |
| 195.122.11 | 12 | 52 | 100 | 12 | 3 | 108,00 € |
| 195.140.11 | 14 | 58 | 110 | 14 | 3 | 150,00 € |
| 195.160.11 | 16 | 55 | 110 | 16 | 3 | 188,00 € |
| 195.161.11 | 16 | 35 | 90 | 16 | 3 | 155,00 € |
| 195.165.11 | 16 | 72 | 120 | 16 | 3 | 200,00 € |
| 195.180.11 | 18 | 55 | 110 | 18 | 3 | 230,00 € |
| 195.200.11 | 20 | 60 | 120 | 20 | 3 | 257,00 € |
| 195.201.11 | 20 | 72 | 120 | 20 | 3 | 267,00 € |
| 195.202.11 | 20 | 102 | 165 | 20 | 3 | 340,00 € |



HWM

KABA TALAŞ KESİM (KİLİT YERİ)

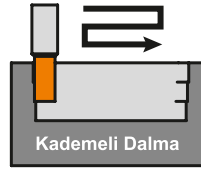

| Order No. | D mm | I mm | I ₁ mm | L mm | S mm | Z | Fiyat |
|------------|------|------|-------------------|------|------|---|----------|
| 195.142.11 | 14 | 95 | 45 | 150 | 14 | 3 | 200,00 € |
| 195.144.11 | 14 | 125 | 45 | 170 | 14 | 3 | 227,00 € |
| 195.162.11 | 16 | 95 | 45 | 150 | 16 | 3 | 218,00 € |
| 195.164.11 | 16 | 120 | 50 | 170 | 16 | 3 | 247,00 € |
| 195.182.11 | 18 | 95 | 45 | 150 | 18 | 3 | 308,00 € |

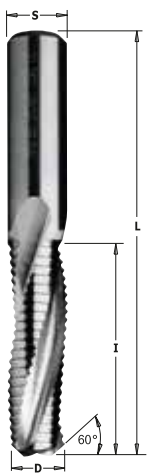

HWM

KABA TALAŞ KESİM (SİVRİ KOL ve GÖZ YERİ)

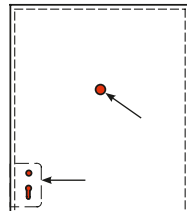
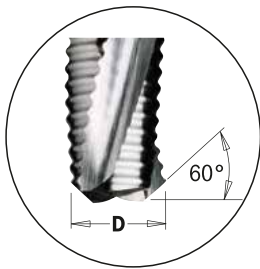

| Order No. | D mm | I mm | I ₁ mm | L mm | S mm | Z | Fiyat |
|------------|------|------|-------------------|------|------|---|----------|
| 195.142.11 | 14 | 95 | 45 | 150 | 14 | 3 | 200,00 € |
| 195.144.11 | 14 | 125 | 45 | 170 | 14 | 3 | 225,00 € |
| 195.162.11 | 16 | 95 | 45 | 150 | 16 | 3 | 220,00 € |
| 195.164.11 | 16 | 120 | 50 | 170 | 16 | 3 | 250,00 € |
| 195.182.11 | 18 | 95 | 45 | 150 | 18 | 3 | 300,00 € |

*Fiyatlarımıza KDV Dahil Değildir.

*Diğer ölçüler için lütfen iletişime geçin.

HWM Karbür Elmas.

40X
 UZUN ÖMÜR

DİA 1+1 EBATLAMA FREZELER

| Order No. | D mm | I mm | L mm | S mm | Z | Fiyat |
|------------|------|------|------|-------|-----------------|----------|
| 140.120.61 | 12 | 27 | 75 | 12x40 | 1+1 (3 DP+1 HW) | 115,00 € |
| 140.121.61 | 12 | 35 | 85 | 12x40 | 1+1 (4 DP+1 HW) | 157,00 € |
| 140.161.61 | 16 | 35 | 93 | 16x50 | 1+1 (4 DP+1 HW) | 157,00 € |
| 140.181.61 | 18 | 35 | 95 | 20x50 | 1+1 (4 DP+1 HW) | 157,00 € |
| 140.182.61 | 18 | 45 | 105 | 20x50 | 1+1 (5 DP+1 HW) | 195,00 € |
| 140.201.61 | 20 | 35 | 95 | 20x50 | 1+1 (5 DP+1 HW) | 157,00 € |
| 140.203.61 | 20 | 55 | 115 | 20x50 | 1+1 (6 DP+1 HW) | 235,00 € |

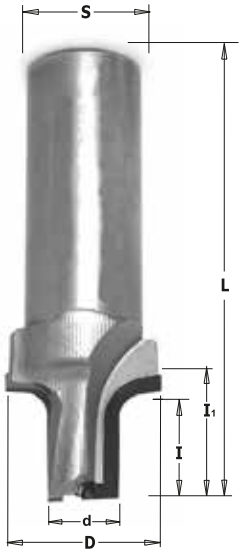
40X
 UZUN ÖMÜR

**DİA NESTİNG EBATLAMA FREZELER
(MEBRAN RADÜS KAPAK)**

| Order No. | D mm | d mm | I mm | I ₁ mm | L mm | S mm | Z | R | Fiyat |
|-----------|------|------|------|-------------------|------|-------|-----|-----|----------|
| NESTİNG | 19 | 12 | 19 | 24 | 85 | 20x50 | 2+1 | 2-5 | 250,00 € |

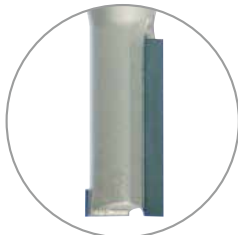

40X
 UZUN ÖMÜR

DİA KANAL FREZELER

***141.101.61 Z1+1**

| Order No. | D mm | I mm | L mm | S mm | Z | Fiyat |
|-------------|------|------|------|-------|-----|----------|
| 141.060.61 | 6 | 8 | 65 | 12x40 | 1 | 105,00 € |
| 141.080.61 | 8 | 12 | 65 | 12x40 | 1 | 125,00 € |
| S141.090.61 | 9 | 15 | 65 | 12x40 | 1 | 190,00 € |
| S141.091.61 | 9 | 15 | 65 | 12x40 | 2 | 290,00 € |
| *141.101.61 | 10 | 22 | 75 | 12x40 | 1+1 | 160,00 € |

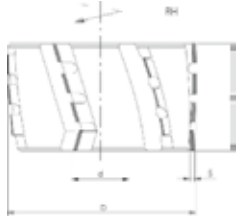
*Diğer ölçüler için lütfen iletişime geçin.

*Fiyatlarımıza KDV Dahil Değildir.



40X
UZUN ÖMÜR



DİA ÖN FREZELER

| Order No. LH | Order No. RH | D | B | b | d | Z | Makina | Fiyat |
|--------------|--------------|-----|----|------|----|-----|-----------|--------------------------------------|
| 10036533 | 10036534 | 85 | 45 | 45 | 30 | 3+3 | Ott | Fiyat bilgisi için irtibata geçiniz. |
| 10021305 | 10021304 | 100 | 34 | 37.6 | 30 | 3+3 | IMA/Brant | Fiyat bilgisi için irtibata geçiniz. |
| 10021307 | 10021306 | 100 | 48 | 40.6 | 30 | 2+2 | IMA/Brant | Fiyat bilgisi için irtibata geçiniz. |
| 10037003 | 10037004 | 100 | 48 | 25 | | 2+2 | HolzHer | Fiyat bilgisi için irtibata geçiniz. |
| 10102851 | | 125 | 43 | 40 | 30 | 3+3 | Homag | Fiyat bilgisi için irtibata geçiniz. |
| 10021303 | | 125 | 63 | 40.6 | 30 | 3+3 | Homag | Fiyat bilgisi için irtibata geçiniz. |
| 10109727 | | 125 | 42 | 47 | 30 | 3+3 | Biesse | Fiyat bilgisi için irtibata geçiniz. |
| 10028686 | 10028687 | 125 | 63 | 40.6 | 30 | 3+3 | IMA | Fiyat bilgisi için irtibata geçiniz. |

| Order No. LH | Order No. RH | D | B | b | d | Z | Makina | Fiyat |
|--------------|--------------|-----|----|------|----|---|-----------|--------------------------------------|
| 1100068 | 1100069 | 100 | 65 | 40.6 | 30 | 3 | IMA/Brant | Fiyat bilgisi için irtibata geçiniz. |
| 1100102 | 1100103 | 125 | 48 | 40.6 | 30 | 3 | IMA | Fiyat bilgisi için irtibata geçiniz. |
| 1100112 | 1100113 | 125 | 65 | 42 | 30 | 3 | IMA | Fiyat bilgisi için irtibata geçiniz. |
| 1100030 | 1100031 | 80 | 43 | 22 | 30 | 3 | IDM | Fiyat bilgisi için irtibata geçiniz. |
| 1100072 | 1100073 | 100 | 65 | 25 | 30 | 3 | HolzHer | Fiyat bilgisi için irtibata geçiniz. |
| 1100098 | | 125 | 43 | 47 | 30 | 3 | Biesse | Fiyat bilgisi için irtibata geçiniz. |
| 1100100 | | 125 | 43 | 40.6 | 30 | 3 | IMA/Homag | Fiyat bilgisi için irtibata geçiniz. |
| 1100106 | | 125 | 65 | 40.6 | 30 | 3 | Homag | Fiyat bilgisi için irtibata geçiniz. |

*Diğer tüm marka makinalar için lütfen iletişime geçin.



*Fiyatlarımıza KDV Dahil Değildir.

*Diğer ölçüler için lütfen iletişime geçin.

JİLETLİ MDF KAPAK MOTİF FREZE SETİ

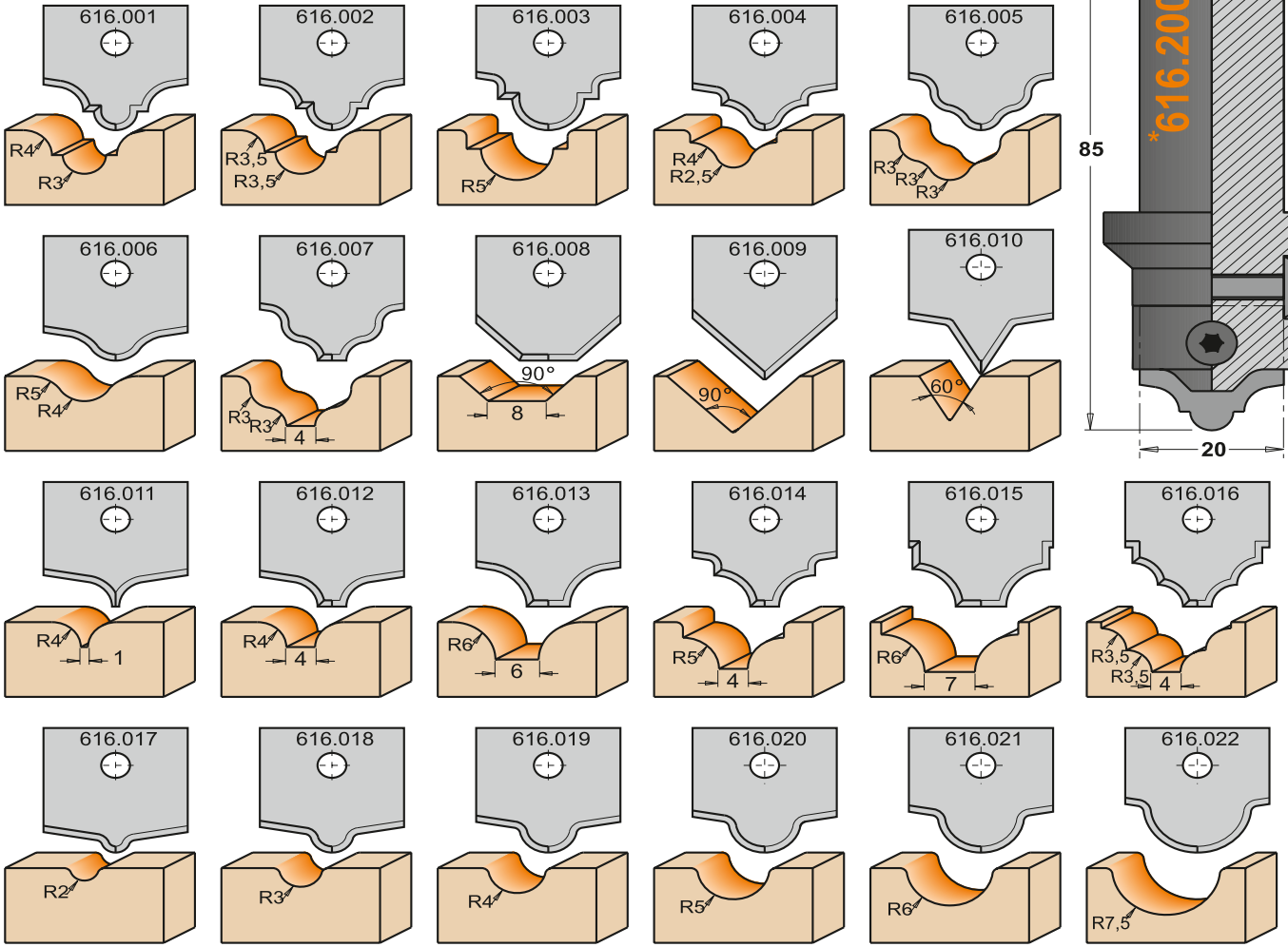
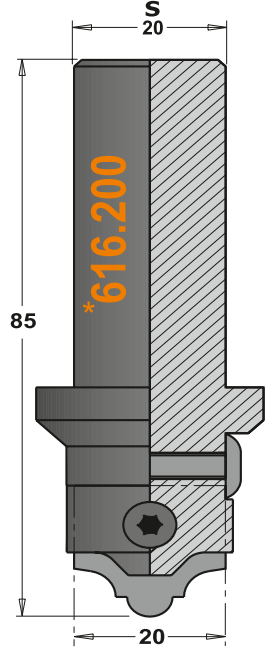

| Order No. | | Fiyat |
|-------------|---|----------|
| 616.000.01 | SET (1 Adet sap, 22 adet jilet) | 565,00 € |
| *616.200 | FREZE SAPI (1 Adet freze sapı) | 90,00 € |
| 616.001-022 | JİLET (İsteğe Göre 001-022 Arası Tek Olarak Jilet Sipariş Verilebilir.) | 23,00 € |

*Diğer ölçüler için lütfen iletişime geçin.

*Fiyatlarımıza KDV Dahil Değildir.



JİLETLİ MDF KAPAK MOTİF FREZE SETİ

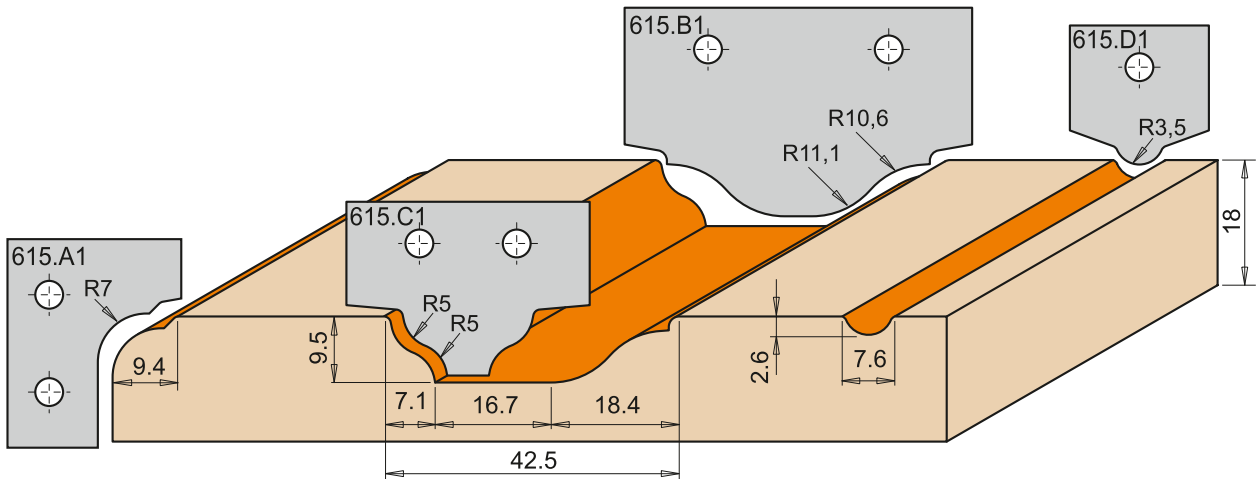
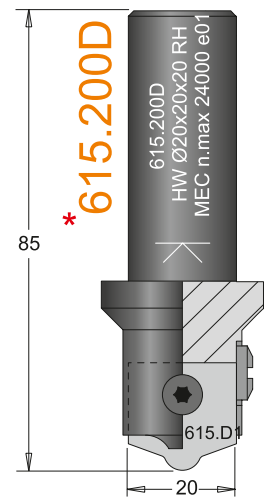
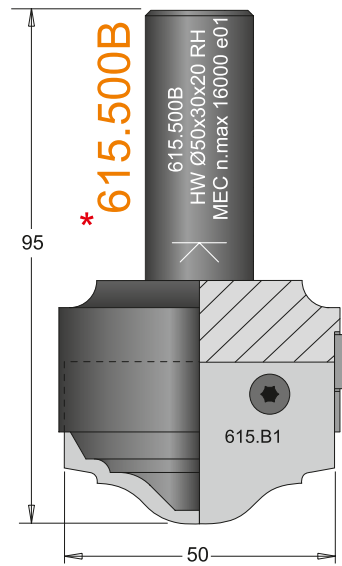
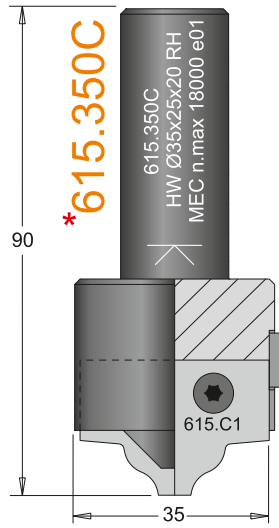
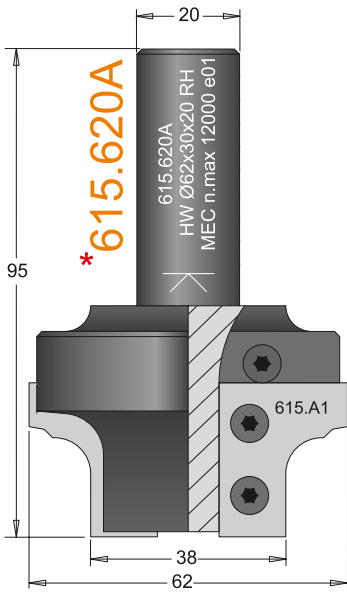

| Order No. | | Fiyat |
|------------|----------------------------|----------|
| 615.004.01 | SET (4 Adet Jiletli Freze) | 720,00 € |
| *615.620A | FREZE SAPI (Jilet Hariç) | 185,00 € |
| *615.350C | FREZE SAPI (Jilet Hariç) | 135,00 € |
| *615.500B | FREZE SAPI (Jilet Hariç) | 160,00 € |
| *615.200D | FREZE SAPI (Jilet Hariç) | 95,00 € |

*İsteğe Göre Ürün Kodu İle Tek Olarak Freze ve Jilet Sipariş Verilebilir.

*Diğer ölçüler için lütfen iletişime geçin.

*Fiyatlarımıza KDV Dahil Değildir.

JİLETLİ PARMAK FREZELER

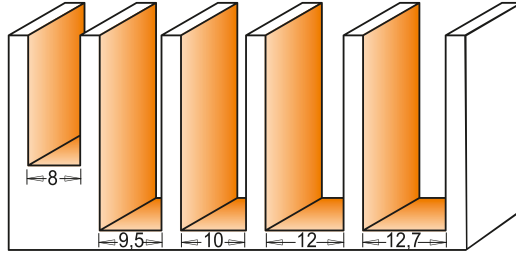
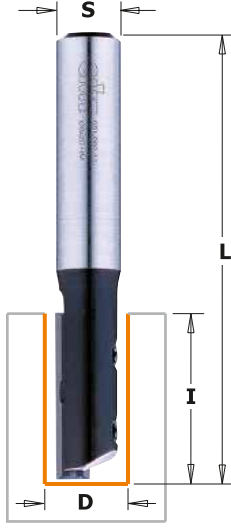

| Order No. | D | I | L | S | Jilet Order No. | Jilet | Fiyat |
|------------|-----|----|----|------|-----------------|------------|---------|
| 651.080.11 | 8 | 20 | 60 | 8 | 790.200.01 | 20x4.1x1.1 | 62,00 € |
| 651.081.11 | 8 | 20 | 67 | 12 | 790.200.01 | 20x4.1x1.1 | 65,00 € |
| 651.695.11 | 9.5 | 30 | 80 | 12.7 | 790.300.01 | 30x5.5x1.1 | 65,00 € |
| 651.101.11 | 10 | 30 | 80 | 12 | 790.300.01 | 30x5.5x1.1 | 65,00 € |
| 651.121.11 | 12 | 30 | 80 | 12 | 790.300.01 | 30x5.5x1.1 | 70,00 € |

JİLETLİ FREZELER



652.161.11



654.662.11



653.701.11

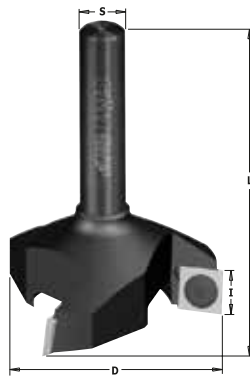

663.004.11



652.690.11B



657.993.11B



657.991.11

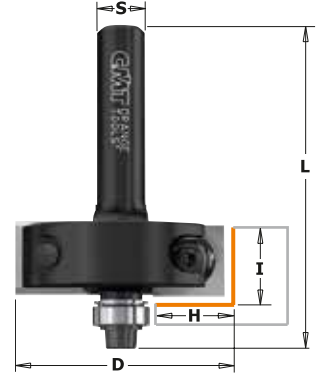

660.851.11



663.101.11

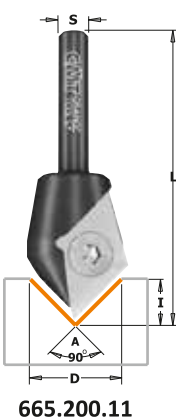

665.200.11

| Order No. | D | I | L | S | Z | Jilet Order No. | Jilet | Fiyat |
|-------------|----|------|-----|------|-----|-------------------------|--------------------------|----------|
| 652.161.11 | 16 | 50 | 96 | 12 | 1 | 790.500.09 | 50x9x1.5 | 67,00 € |
| 654.662.11 | 16 | 49.5 | 105 | 20 | 2 | 790.495.12 | 49,5x12x1,5 | 90,00 € |
| 653.701.11 | 20 | 48.3 | 111 | 20 | 1+1 | 790.483.12 + 790.096.00 | 48.3x12x1.5 + 9.6x12x1.5 | 97,00 € |
| 663.004.11 | 60 | 12 | 80 | 12 | 3 | 790.120.00 | 12x12x1.5 | 95,00 € |
| 652.690.11B | 19 | 49.5 | 100 | 12 | 1 | 790.495.09 | 49.5x9x1.5 | 70,00 € |
| 657.993.11B | 19 | 50 | 110 | 12 | 2 | 790.500.00 | 50x12x1,5 | 70,00 € |
| 657.991.11 | 19 | 50 | 112 | 12 | 2 | 790.500.00 | 50x12x1,5 | 70,00 € |
| 660.851.11 | 35 | 12 | 65 | 12,7 | 2 | 790.120.00 | 12x12x1,5 | 60,00 € |
| 663.101.11 | 52 | 25 | 100 | 20 | 1 | 790.360.01 | 36x12x1.5 | 135,00 € |
| 665.200.11 | 23 | 11 | 60 | 8 | 1 | 790.280.00 | 28x14x2 | 25,00 € |

*Fiyatlarımıza KDV Dahil Değildir.

*Diğer ölçüler için lütfen iletişime geçin.



ELMAS FREZELER



915.690.11 / 915.380.11

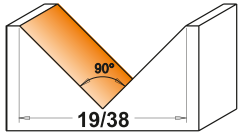

915.160.11B

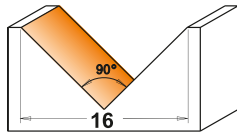

958.001.11

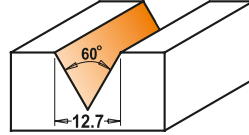

Alüminyum Kompozit



915.001.11

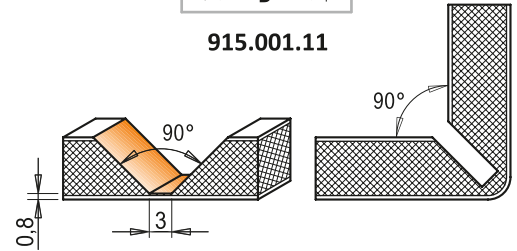

Kılavuzlu Panel Uç

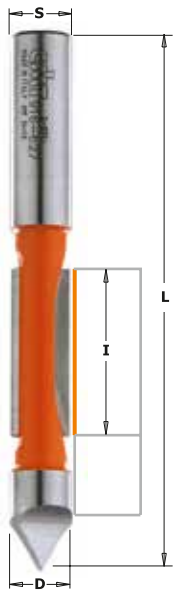

916.627.11

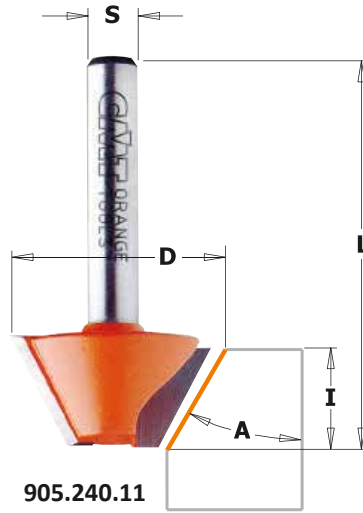
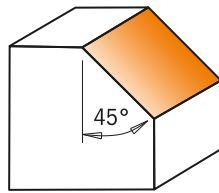

905.240.11

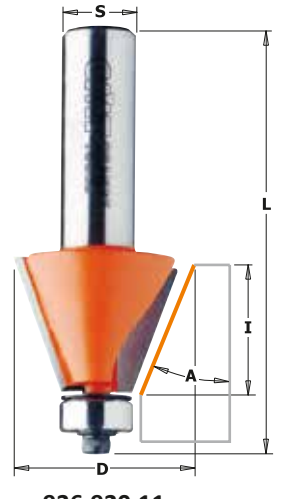

936.920.11



| Order No. | D | I | I ₁ | A | L | S | Z | Fiyat |
|-------------|------|------|----------------|-----|------|----|---|---------|
| 915.690.11 | 19 | 16 | 9.5 | 90° | 63.5 | 12 | 2 | 28,00 € |
| 915.380.11 | 38 | 28.5 | 19 | 90° | 63.5 | 8 | 2 | 49,00 € |
| 915.160.11B | 16 | 12.7 | 8 | 90° | 53 | 8 | 2 | 35,00 € |
| 958.001.11 | 12.7 | 11 | | 60° | 57.2 | 8 | 3 | 28,00 € |
| 915.001.11 | 18 | 7.4 | | 90° | 60 | 8 | 2 | 34,00 € |
| 916.627.11 | 12 | 31.7 | | | 102 | 12 | 2 | 29,00 € |
| 905.240.11 | 25 | 8 | | 45° | 41 | 8 | 2 | 18,00 € |
| 936.920.11 | 45 | 18 | | 45° | 67 | 12 | 2 | 33,00 € |

*Fiyatlarımıza KDV Dahil Değildir.

*Diğer ölçüler için lütfen iletişime geçin.

HWM Karbür Elmas.

HWM Çelik/Karbür.



BİLYALI TARAMA FREZELER

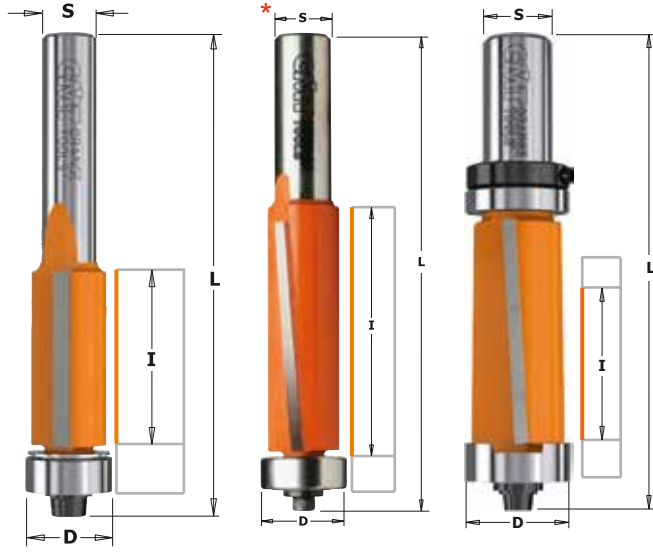

706.064.11
706.127.11

906.629.11
906.630.11

906.690.11B

| Order No. | D | I | A | L | S | Z | Fiyat |
|-------------|------|------|-----|-----|----|---|---------|
| 706.064.11 | 6.35 | 25.4 | 0° | 64 | 6 | 2 | 25,00 € |
| 706.127.11 | 12.7 | 25.4 | -3° | 71 | 6 | 2 | 23,00 € |
| 906.629.11 | 12.7 | 38.1 | 0° | 94 | 12 | 2 | 32,00 € |
| 906.630.11 | 12.7 | 50.8 | 0° | 104 | 12 | 2 | 34,00 € |
| *906.692.11 | 19 | 38.1 | -3° | 93 | 12 | 2 | 36,00 € |
| *906.690.11 | 19 | 50.8 | -3° | 110 | 12 | 2 | 40,00 € |
| 906.690.11B | 19 | 50,8 | -3° | 110 | 12 | 2 | 40,00 € |

DÜZ TARAMA FREZELER

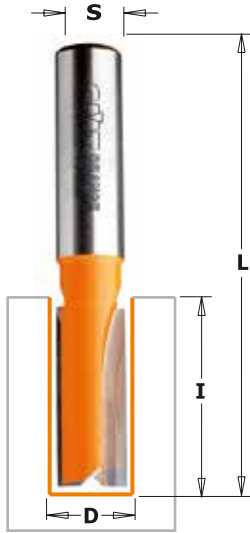

| Order No. | D | I | A | L | S | Z | Fiyat |
|------------|----|------|----|-----|----|---|---------|
| 912.590.11 | 9 | 31.7 | 0° | 75 | 12 | 2 | 24,00 € |
| 912.600.11 | 10 | 31.7 | 0° | 75 | 12 | 2 | 24,00 € |
| 912.621.11 | 12 | 38.1 | 0° | 95 | 12 | 2 | 25,00 € |
| 912.622.11 | 12 | 50.8 | 0° | 108 | 12 | 2 | 29,00 € |
| 912.690.11 | 19 | 38,1 | 0° | 82 | 12 | 2 | 26,00 € |

RADÜS TARAMA FREZELER

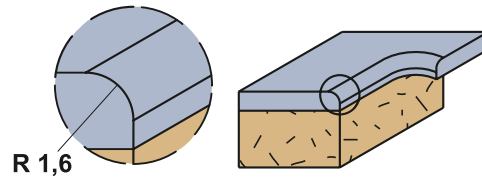
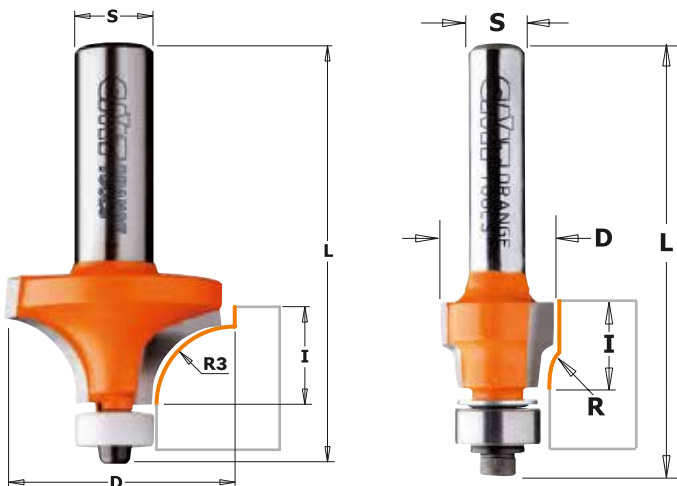

| Order No. | D | I | R | L | S | Z | Fiyat |
|------------|------|------|-----|----|------|---|---------|
| 807.015.11 | 12.7 | 9.5 | 1,6 | 52 | 6.35 | 2 | 27,00 € |
| 907.015.11 | 12.7 | 9.5 | 1,6 | 52 | 8 | 2 | 27,00 € |
| 938.187.11 | 18.7 | 12.7 | 3 | 53 | 8 | 2 | 27,00 € |

HWM Karbür Elmas.

HW Çelik/Karbür.

*Fiyatlarımıza KDV Dahil Değildir.

*Diğer ölçüler için lütfen iletişime geçin.

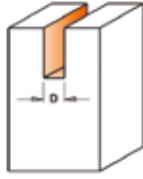

HWM

KANAL FREZELER

| Order No. | D | I | L | S | Z | Fiyat |
|------------|---|----|----|---|-----|---------|
| 174.030.11 | 3 | 10 | 55 | 8 | 2+1 | 22,00 € |
| 174.040.11 | 4 | 10 | 55 | 8 | 2+1 | 22,00 € |
| 174.050.11 | 5 | 12 | 55 | 8 | 2+1 | 22,00 € |
| 174.060.11 | 6 | 14 | 55 | 8 | 2+1 | 23,00 € |
| 174.070.11 | 7 | 20 | 55 | 8 | 2+1 | 25,00 € |

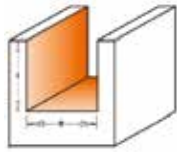

HW HWM

KAYNAKLI FREZELER

| Order No. | D | I | L | S | Z | Fiyat |
|------------|----|----|----|----|-----|---------|
| 175.040.11 | 4 | 10 | 65 | 10 | 2+1 | 22,00 € |
| 175.050.11 | 5 | 12 | 65 | 10 | 2+1 | 22,00 € |
| 175.060.11 | 6 | 14 | 65 | 10 | 2+1 | 23,00 € |
| 175.070.11 | 7 | 17 | 65 | 10 | 2+1 | 25,00 € |
| 175.080.11 | 8 | 20 | 65 | 10 | 2+1 | 26,00 € |
| 175.100.11 | 10 | 25 | 70 | 10 | 2+1 | 28,00 € |
| 175.120.11 | 12 | 25 | 70 | 10 | 2+1 | 32,00 € |



HW

KAYNAKLI FREZELER

| Order No. | D | I | L | S | Z | Fiyat |
|------------|----|----|-----|----|-----|---------|
| 177.100.11 | 10 | 35 | 90 | 12 | 2+1 | 31,00 € |
| 177.120.11 | 12 | 35 | 90 | 12 | 2+1 | 32,00 € |
| 177.121.11 | 12 | 50 | 100 | 12 | 2+1 | 40,00 € |
| 177.140.11 | 14 | 35 | 90 | 12 | 2+1 | 33,00 € |
| 177.160.11 | 16 | 35 | 90 | 12 | 2+1 | 36,00 € |
| 177.161.11 | 16 | 60 | 110 | 12 | 2+1 | 48,00 € |
| 177.181.11 | 18 | 60 | 110 | 12 | 2+1 | 48,00 € |

*Fiyatlarımıza KDV Dahil Değildir.

*Diğer ölçüler için lütfen iletişime geçin.

HWM Karbür Elmas.

HW Çelik/Karbür.

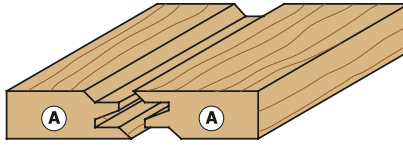
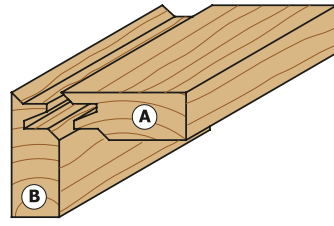
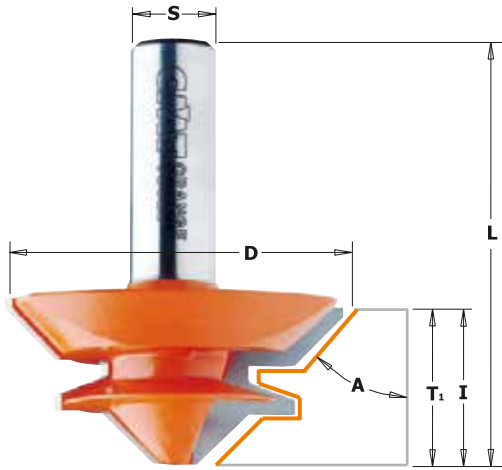

GÖNYELİ EKLEM FREZELER

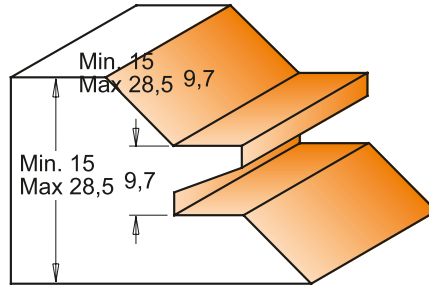
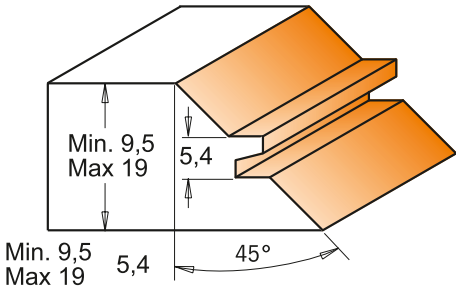
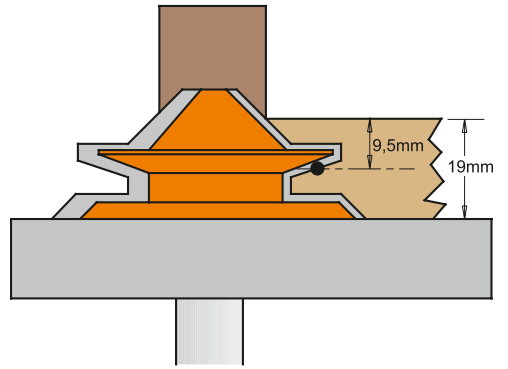
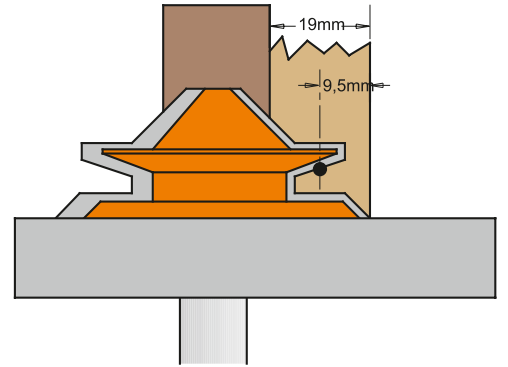

| Order No. | D | I | A | L | S | T ₁ | Z | Fiyat |
|------------|------|------|-----|----|----|----------------|---|---------|
| 955.503.11 | 70 | 31.7 | 45° | 70 | 12 | 15 + 28.5 | 2 | 97,00 € |
| 955.504.11 | 50.8 | 22.2 | 45° | 60 | 12 | 9.5 + 19 | 2 | 71,00 € |

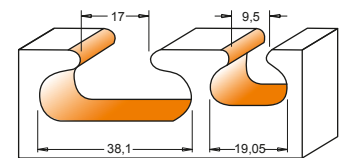
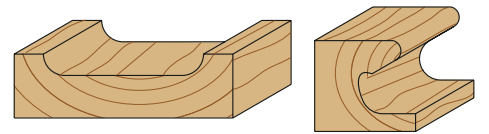
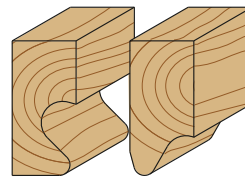
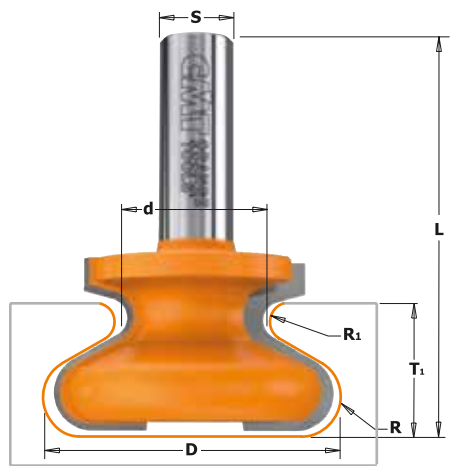

GÖMME KULP FREZESİ

| Order No. | D | d | T ₁ | I | R | R ₁ | L | Fiyat |
|------------|-------|-----|----------------|-------|------|----------------|------|---------|
| 955.102.11 | 19,05 | 9,5 | 14 | 19,05 | 4,76 | 2,4 | 57,2 | 32,00 € |
| 955.103.11 | 38,1 | 17 | 18 | 20,7 | 6,00 | 1,8 | 55,5 | 40,00 € |

*Diğer ölçüler için lütfen iletişime geçin.

*Fiyatlarımıza KDV Dahil Değildir.



JİLETLİ TEMİZLEME TOPU

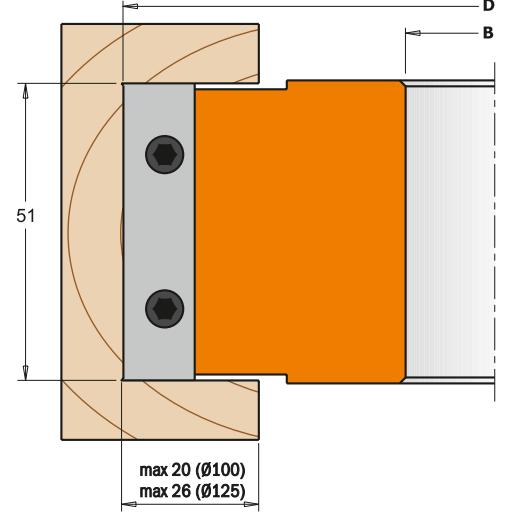

| Order No. | D | I | B | Z+V | RPM | Jilet Order No. | Jilet | Fiyat |
|------------|-----|----|----|-----|--------------|-------------------------|---------------------|----------|
| 694.100.30 | 100 | 51 | 30 | 2+4 | 7500 - 12500 | 790.500.00 + 790.140.00 | 50x12x1.5 + 14x14x2 | 155,00 € |
| 694.125.50 | 125 | 51 | 50 | 2+4 | 6100 - 10000 | 790.500.00 + 790.140.00 | 50x12x1.5 + 14x14x2 | 165,00 € |

JİLETLİ TEMİZLEME TOPU

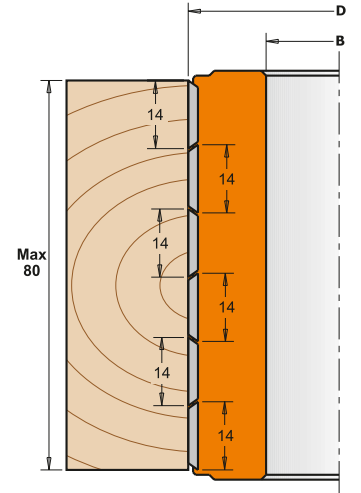
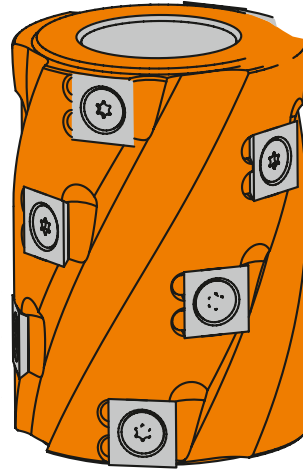

| Order No. | D | I | B | Z | RPM | Jilet Order No. | Jilet | Fiyat |
|------------|----|----|----|----|--------------|-----------------|---------|----------|
| 694.019.30 | 62 | 80 | 30 | 12 | 8000 - 12000 | 790.140.00 | 14x14x2 | 195,00 € |

*Fiyatlarımıza KDV Dahil Değildir.

*Diğer ölçüler için lütfen iletişime geçin.



45 DERECE JİLETLİ FREZE TOPU

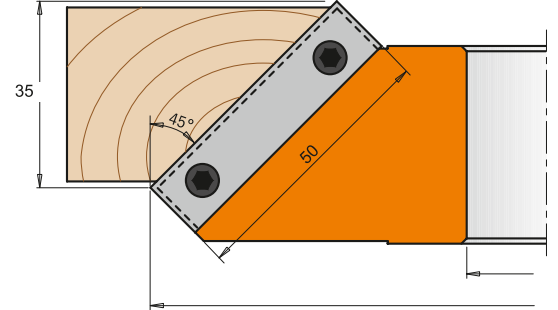

| Order No. | D | B | Z | RPM | Jilet Order No. | Jilet | Fiyat |
|------------|-----|----|---|-------------|-----------------|-----------|----------|
| 694.002.30 | 150 | 30 | 2 | 5100 - 8800 | 790.500.00 | 50x12x1.5 | 190,00 € |

AYARLANABİLİR AÇILI JİLETLİ FREZE TOPU

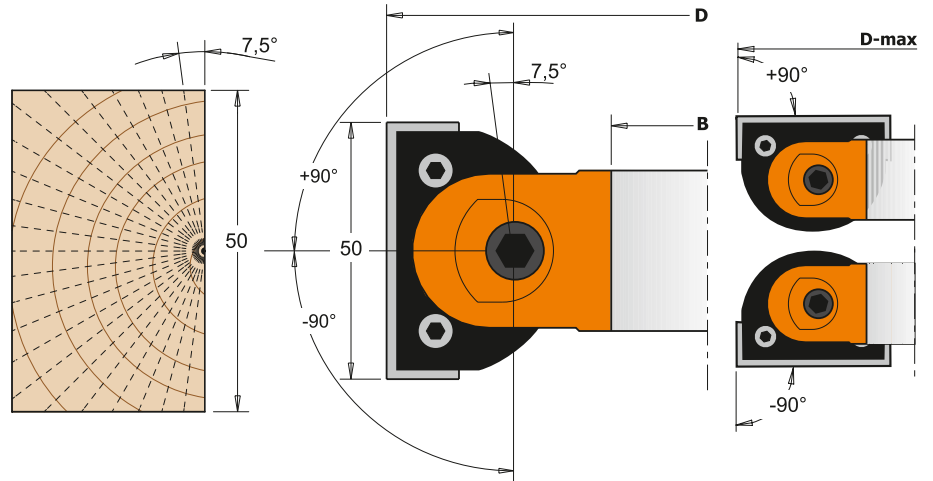

| Order No. | D | I | B | Z | D_Max 45° | RPM | Jilet Order No. | Jilet | Fiyat |
|------------|-----|----|----|---|-----------|-------------|-----------------|-----------|----------|
| 694.017.30 | 160 | 50 | 30 | 2 | 183 | 4800 - 6000 | 790.500.00 | 50x12x1.5 | 510,00 € |

*Diğer ölçüler için lütfen iletişime geçin.

*Fiyatlarımıza KDV Dahil Değildir.



JİLETLİ KANAL FREZE TOPU

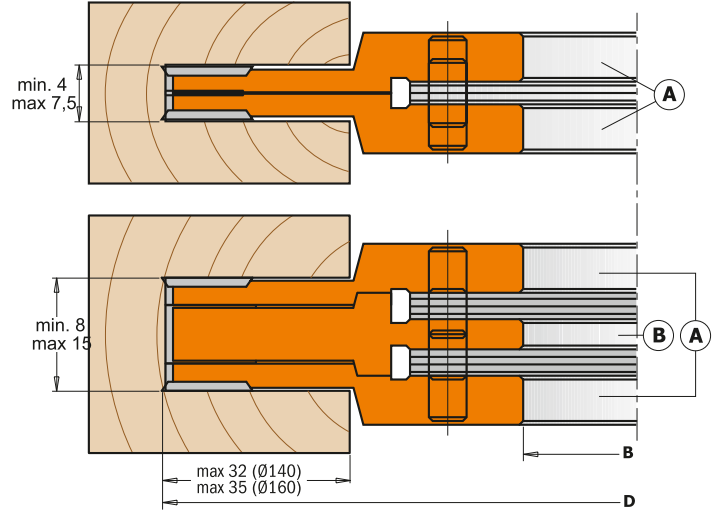

| Order No. | D | I | B | Z+V | RPM | Jilet Order No. | Fiyat |
|------------|-----|--------|----|-----|-------------|--|----------|
| 694.001.30 | 140 | 4 - 15 | 30 | 4+4 | 5500 - 9500 | 790.181.00 + 790.140.10 + 790.076.00 18x18x2 + 14x14x1.2 + 7.6x12x1.5 | 390,00 € |

JİLETLİ KANAL FREZE TOPU

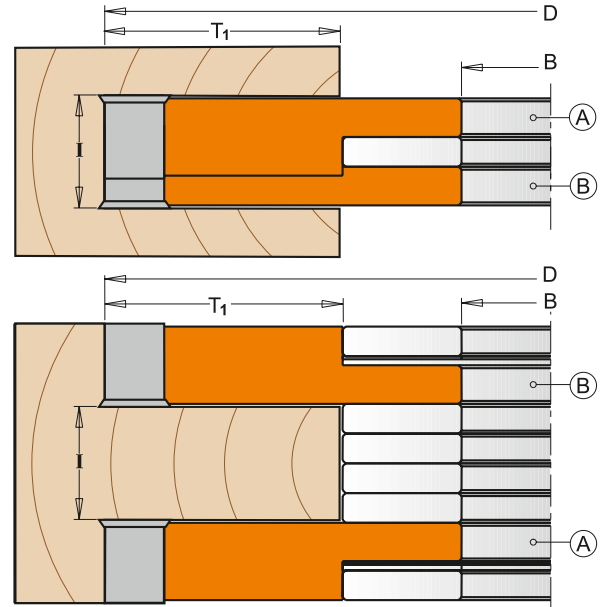
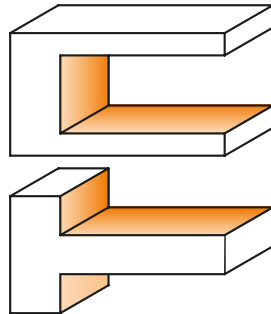

| Order No. | D | I | T ₁ | B | Z+V | RPM | Jilet Order No. | Jilet | Fiyat |
|------------|-----|-------|----------------|----|-----|-------------|-----------------|-------------|----------|
| 694.021.30 | 150 | 14-27 | 44 | 30 | 4+4 | 5000 - 8000 | 790.136.00 | 13.6x13.6x2 | 220,00 € |

*Fiyatlarımıza KDV Dahil Değildir.

*Diğer ölçüler için lütfen iletişime geçin.



JİLETLER

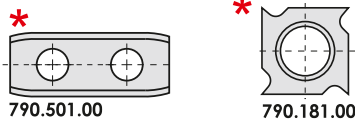
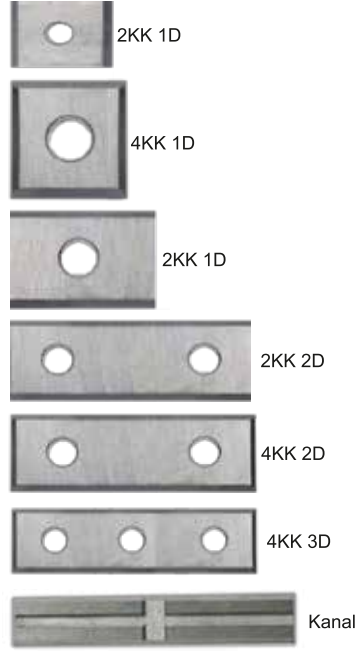
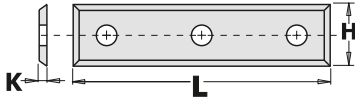

| TIGRA | | CMT | Keskin Kenar | Delik | Ölçüler L x H x K | Fiyat |
|----------|--------|-------------|--------------|-------|-------------------|---------|
| Order No | Sınıf | Order No | | | | |
| T-012001 | T04F | 790.075.00 | 2 KK | 1 D | 7,5x12x1,5 | 1,80 € |
| T-012015 | T04F | 790.096.00 | 2 KK | 1 D | 9,6x12x1,5 | 2,20 € |
| T-012002 | T04F | 790.120.00 | 4 KK | 1 D | 12x12x1,5 | 2,10 € |
| T-013295 | T08F | 790.140.10 | 4 KK | 1 D | 14x14x1,2 | 2,40 € |
| T-013260 | T04F | 790.140.00 | 4 KK | 1 D | 14x14x2,0 | 2,10 € |
| T-012003 | T04F | * | 2 KK | 1 D | 15x12x1,5 | 2,20 € |
| T-012004 | T04F | 790.200.00 | 2 KK | 1 D | 20x12x1,5 | 2,70 € |
| T-012011 | T04F | 790.250.00 | 2 KK | 2 D | 25x12x1,5 | 3,40 € |
| T-012005 | T04F | 790.300.00 | 2 KK | 2 D | 30x12x1,5 | 3,40 € |
| T-013828 | T03SMG | 790.300.03 | 2 KK | 2 D | 30x12x1,5 | 4,25 € |
| T-012014 | T04F | 790.400.00 | 2 KK | 2 D | 40x12x1,5 | 4,00 € |
| T-012006 | T04F | 790.500.00 | 2 KK | 2 D | 50x12x1,5 | 4,20 € |
| T-013834 | T03SMG | 790.501.00 | 2 KK | 2 D | 50x12 x1,5 | 5,20 € |
| T-012007 | T04F | 790.600.00 | 2 KK | 2 D | 60x12x1,5 | 5,35 € |
| T-013293 | T04F | *790.181.00 | 4 KK | 1 D | 18x18x2,0 | 7,30 € |
| T-013271 | T08F | *790.220.02 | 3 KK | 1 D | 22x19x2,0 | 9,00 € |
| T-013950 | T03SMG | 790.295.09 | 4 KK | 2 D | 29,5x9,0x1,5 | 5,20 € |
| T-013517 | T04F | 790.495.09 | 4 KK | 2 D | 49,5x9,0x1,5 | 6,30 € |
| T-013956 | T03SMG | * | 4 KK | 2 D | 49,5x9,0x1,5 | 7,00 € |
| T-013507 | T04F | 790.295.12 | 4 KK | 2 D | 29,5x12x1,5 | 4,60 € |
| T-013952 | T03SMG | * | 4 KK | 2 D | 29,5x12x1,5 | 5,50 € |
| T-013957 | T03SMG | 790.495.12 | 4 KK | 2 D | 49,5x12x1,5 | 7,00 € |
| T-013327 | T04F | * | 4 KK | 3 D | 50x12x1,7 | 7,00 € |
| T-013866 | T03SMG | * | 4 KK | 3 D | 50x12x1,7 | 8,25 € |
| T-013403 | T04F | 790.200.01 | Kanal | * | 20x4,1x1,1 | 3,90 € |
| T-013394 | T04F | * | Kanal | * | 20x5,5x1,1 | 4,10 € |
| T-013402 | T04F | * | Kanal | * | 25x5,5x1,1 | 4,25 € |
| T-013397 | T04F | 790.300.01 | Kanal | * | 30x5,5x1,1 | 4,35 € |
| T-013401 | T04F | 790.500.01 | Kanal | * | 50x5,5x1,1 | 6,65 € |
| T-013020 | T08F | 790.820.00 | Kanal | * | 82x5,5x1x1 | 2,90 € |
| CMT | K1920 | 790.500.09 | 4 KK | 3 D | 50x9,0x1,5 | 10,30 € |
| CMT | K1920 | *790.280.00 | 4 KK | 1 D | 28x14x 2,0 | 8,00 € |
| CMT | K1920 | 790.360.01 | 4 KK | 2 D | 36x12x1,5 | 10,60 € |
| CMT | K1920 | 790.483.12 | 4 KK | 2 D | 48.3x12x1.5 | 14,00 € |
| CMT | K1920 | *790.501.00 | 2 KK | 2 D | 48.3x12x1.6 | 8,65 € |

HSS PLANYALAR

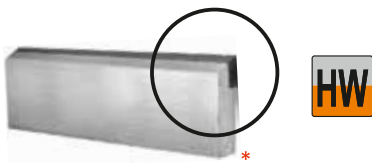

| Order No. LH | Ölçü | HSS Sınıfı | Fiyat |
|--------------|-----------|------------|----------|
| *792.999.30 | 1050x30x3 | HW Elmas | 180,00 € |

| Order No. LH | Ölçü | HSS Sınıfı | Fiyat |
|--------------|-----------|------------|---------|
| 792.301.30 | 300x30x3 | %6 | 9,00 € |
| 792.311.35 | 310x35x3 | %6 | 9,30 € |
| 792.401.35 | 400x35x3 | %6 | 12,00 € |
| 792.501.35 | 500x35x3 | %6 | 15,00 € |
| 792.601.35 | 600x35x3 | %6 | 18,00 € |
| 792.998.35 | 1050x35x3 | %6 | 31,50 € |

| Order No. LH | Ölçü | HSS Sınıfı | Fiyat |
|--------------|-----------|------------|---------|
| 792.250.30 | 250x30x3 | %18 | 12,60 € |
| 792.300.30 | 300x30x3 | %18 | 15,00 € |
| 792.400.30 | 400x30x3 | %18 | 20,00 € |
| 792.500.30 | 500x30x3 | %18 | 25,00 € |
| 792.997.30 | 1050x30x3 | %18 | 52,50 € |

*Fiyatlarımıza KDV Dahil Değildir.

*Diğer ölçüler için lütfen iletişime geçin.



Neden Poliüretan Toz Emme Hortumu!

Tüm talaş emme sistemlerinde kullanılan ve sürtünmeden dolayı makinelerinizin elektriksel ekipmanlarına zarar verebilecek, yangın riskini arttıran elektriği, topraklamaya yardımcı olan bakır kaplı spiral tellerden imal endüstriyel toz emme hortumlarını da, tüm ölçülerde sizlere sunmaktayız.



| | |
|----------------|---------------------------|
| PU 60 | HAFIF HİZMET AMAÇLI |
| TEL CİNSİ: | SG-2 ANTİSTATİK ÇELİK TEL |
| RENK : | ŞEFFAF |
| ET KALINLIĞI : | 0,40 - 0,45 mm |
| TEL ARALIĞI : | 15 mm - 32 mm |

| | |
|----------------|----------------------------|
| PU 70 | ORTA HİZMET AMAÇLI |
| TEL CİNSİ: | BAKIR ANTİSTATİK ÇELİK TEL |
| RENK : | ŞEFFAF |
| ET KALINLIĞI : | 0,40 - 0,45 mm |
| TEL ARALIĞI : | 15 mm - 32 mm |

| | |
|----------------|-----------------------|
| PU 100 | AĞIR HİZMET AMAÇLI |
| TEL CİNSİ: | BAKIR KAPLI ÇELİK TEL |
| RENK : | ŞEFFAF |
| ET KALINLIĞI : | 0,55 - 0,60 mm |
| TEL ARALIĞI : | 15 mm - 32 mm |

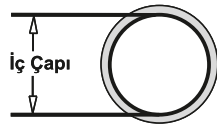

| Ölçü | Fiyat | | |
|----------|---------|---------|---------|
| | mt/€ | mt/€ | mt/€ |
| Ø 60 mm | 6,50 € | 8,00 € | 10,00 € |
| Ø 70 mm | 6,50 € | 9,00 € | 12,00 € |
| Ø 80 mm | 7,00 € | 10,50 € | 12,50 € |
| Ø 102 mm | 8,00 € | 12,00 € | 15,50 € |
| Ø 110 mm | 8,50 € | 12,50 € | 16,00 € |
| Ø 120 mm | 9,00 € | 13,50 € | 17,00 € |
| Ø 130 mm | 10,50 € | 15,50 € | 20,00 € |
| Ø 140 mm | 11,50 € | 17,50 € | 21,50 € |
| Ø 152 mm | 12,00 € | 18,50 € | 23,00 € |
| Ø 160 mm | 13,00 € | 20,00 € | 25,50 € |
| Ø 180 mm | 15,00 € | 22,00 € | 28,50 € |
| Ø 203 mm | 17,00 € | 25,00 € | 31,50 € |
| Ø 225 mm | 20,00 € | 30,00 € | 38,00 € |
| Ø 250 mm | 23,00 € | 33,00 € | 43,00 € |
| Ø 275 mm | 25,00 € | 47,50 € | 47,00 € |
| Ø 305 mm | 29,00 € | 57,00 € | 71,00 € |

*PU 60 ve PU 70 Paketi 10 Mt dir. Minimum Sipariş Miktarı 10 Mt dir.
*PU 100 İsteğe Göre Mt. Olarak Sipariş Verilebilir.

*Fiyatlarımıza KDV Dahil Değildir.

*Hortumla ilgili diğer ölçüler için lütfen iletişime geçin.

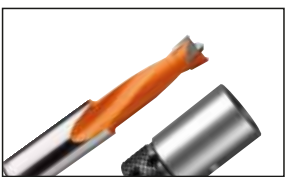

CMT ORANGE
TOOLS®

**ORMEND MAKİNA
SAN. TİC. LTD. ŞTİ.**

**CMT ORANGE TOOLS ÜRÜNLERİNİN
BAYİLERE DAĞITIMI VE TÜRKİYE GENELİNDE
TEMSİLCİLİK KONUSUNDA
TEK YETKİLİDİR.**

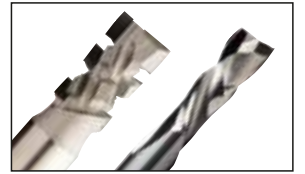

ormendmakina



ormendmakina



ormendmakina



ormendmakina





ORMEND
MAKİNA SAN. TİC. LTD. ŞTİ.

Şerifali Mah. Türker Cad. No: 32/A,
34775, Ümraniye / İstanbul / TÜRKİYE
T: +90 216 527 01 12 - 13
F: +90 216 527 01 14
info@ormendmakina.com
www.ormendmakina.com



ormendmakina



ormendmakina



ormendmakina



ormendmakina