



MACHINES FOR INDUSTRIAL PACKAGING





UNIÓN EUROPEA

Fondo Europeo de Desarrollo Regional

“Una manera de hacer Europa”



Te ayudamos a crecer en el exterior

ABOUT US

Frimaq Packaging, founded in 1999, is a Spanish manufacturer of all types of machinery for industrial packaging, comprising a wide range of machinery from small vacuum packaging machines to large packaging lines, tray sealing machines, thermoforming machines, dryers, shrink tunnels, and a multitude of peripherals that complement our products, as well as the different needs of our customers.

FRIMAQ machines are born from the joint collaboration with leading companies in the different production sectors and in the different world markets. A continuous challenge for FRIMAQ is the perfect packaging of the product: we are constantly working on the development and improvement of our systems and machines, using new cutting-edge technologies, which, together with a great experience, allow FRIMAQ to look beyond the machine, placing the customer's needs as a target and creating a constant relationship of advice and assistance, able to offer solutions to the most complex problems that the different sectors present. Therefore, it is the tailor-made work and the contribution of solutions to our customers that makes us unique.

Frimaq is a company that is well established in a large number of markets and is constantly expanding. We are currently present on all continents and in more than 50 countries, where we have official distributors of our brand.

SOBRE NOSOTROS

Frimaq Packaging nace en 1999. Es una empresa española fabricante de todo tipo de maquinaria para el envasado industrial, comprendiendo un amplio abanico de maquinaria desde pequeñas envasadoras de vacío a grandes líneas de envasado, termoselladoras, termoformadoras, secadoras, túneles de retractilado, y multitud de periféricos que complementan nuestros productos, así como las distintas necesidades de nuestros clientes.

Las máquinas de FRIMAQ nacen de la colaboración conjunta con empresas líder en los distintos sectores de producción y en los distintos mercados mundiales. Un desafío continuo para FRIMAQ es el perfecto envasado del producto. Trabajamos constantemente para el desarrollo y perfeccionamiento de nuestros sistemas y máquinas utilizando nuevas tecnologías de vanguardia, que unida a una gran experiencia, permiten a FRIMAQ mirar más allá de la máquina, situando las necesidades del cliente como objetivo y creando una relación constante de asesoría y asistencia, capaz de ofrecer soluciones a los problemas más complejos que los diferentes sectores presentan. Por tanto, es el trabajo a medida y el aporte de soluciones a nuestros clientes, lo que nos hace únicos.

Frimaq es una empresa afianzada en un amplio número de mercados y en constante expansión. Actualmente estamos presente en todos los continentes y en más de 50 países, donde contamos con distribuidores oficiales de nuestra marca.

THERMOFORMERS

TERMOFORMADORAS

FLEXIBLE · RIGID · SHRINK · SKIN
 FLEXIBLE · RÍGIDO · RETRÁCTIL · SKIN

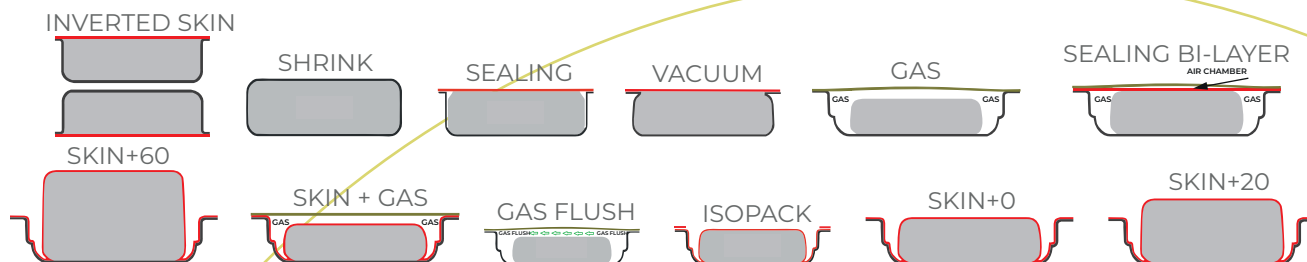

Our thermoforming machines adapt to all types of production needs, both medium and high. They work with different materials, flexible, rigid, shrinkable. And they work with different packaging systems: vacuum, gas and skin, among others. At Frimaq we manufacture them according to your needs. We are professionals in industrial machinery.

Nuestras termoformadoras se adaptan a todo tipo de necesidades de la producción, tanto media como alta. Funcionan con diferentes materiales, flexibles, rígidos, retráctiles.. Y trabaja con distintos sistemas de envasado: vacío, gas y skin entre otros. En Frimaq la fabricamos según tus necesidades. Somos profesionales de la maquinaria industrial.



Straight, rounded and shaped cutting.
 Cortes rectos, redondeados y con forma.

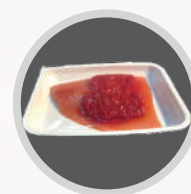

TFF + MC1000

PAPERBOARDS · FLEXIBLE · RIGID · SKIN
CARTÓN · FLEXIBLE · RÍGIDO · SKIN

With this cardboard tray manufacturing module, Frimaq is committed to a more sustainable solution in the packaging industry, allowing for in-house tray manufacturing and helping to reduce the use of plastic by almost 80%.

Con este módulo de fabricación de bandejas de cartón, Frimaq apuesta por una solución más sostenible en la industria del envasado permitiendo la fabricación propia de bandejas y ayudando a reducir el uso del plástico en casi un 80%.

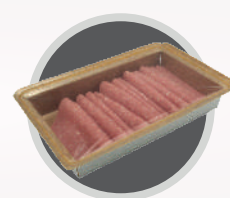
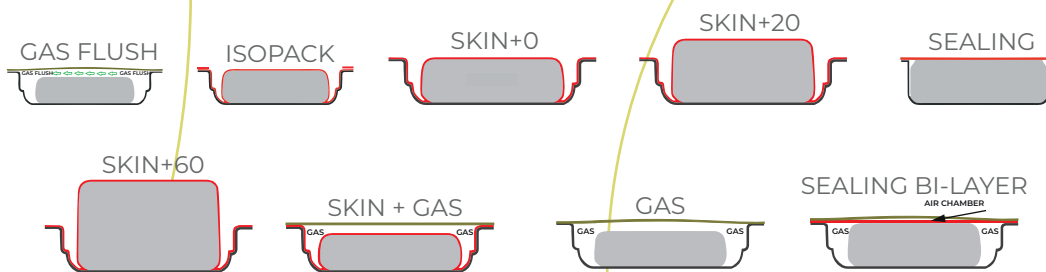

AUTOMATIC TRAYSEALERS

TERMOSELLADORAS AUTOMÁTICAS

VACUUM · GAS · SKIN
 VACÍO · GAS · SKIN

Our tray sealers are suitable for all types of production requirements, from medium to high production. They work with different types of prefabricated trays, as well as cardboard and flat cardboard trays. Our machines are able to work with different packaging systems: vacuum, gas, and skin among others.

Nuestras termoselladoras se adaptan a todo tipo de necesidades de la producción, tanto media como alta. Funcionan con diferentes tipos de bandejas prefabricadas, así como también bandejas de cartón y cartón plano. Nuestras máquinas son capaces de trabajar con distintos sistemas de envasado: vacío, gas, y skin entre otros.



▶ TSA-626
 TSA-826

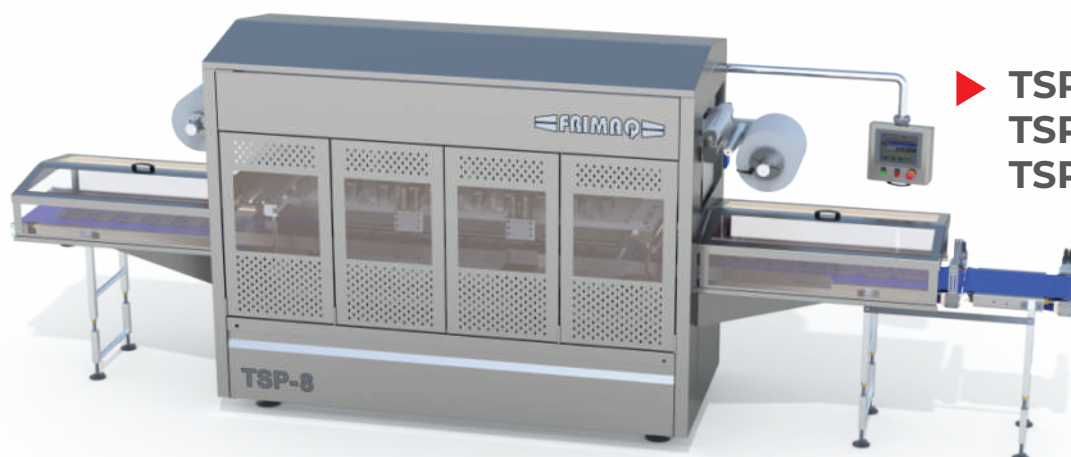

▶ TSP-8
 TSP-6
 TSP-4

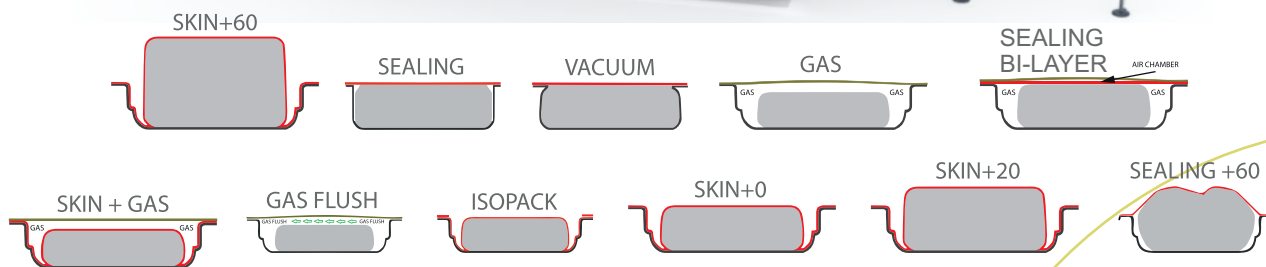

SEMIAUTOMATIC TRAYSEALERS

TERMOSELLADORAS SEMIAUTOMÁTICAS

VACUUM · GAS · SKIN
VACÍO · GAS · SKIN

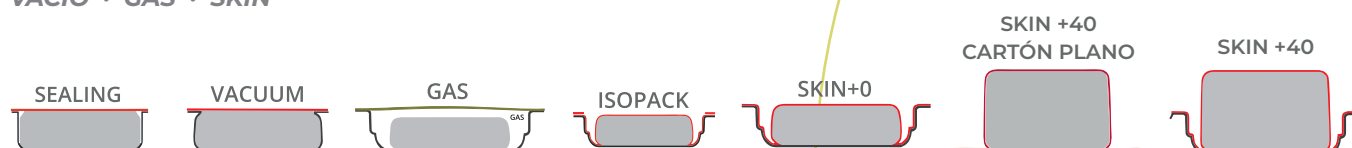

MINI-2 ◀

Our semi-automatic tray sealer models are designed for low and medium productions. Without skimping on quality and details, our Mini and Maxi machines allow packaging in all types of materials from prefabricated trays and even flat cardboard, and with different packaging systems:



MAXI SKIN+40 ◀

Los modelos de nuestras termoselladoras semiautomaticas están diseñados para producciones bajas y medias. Sin escatimar en calidad y detalles nuestra Mini y Maxi permiten el envasado en todo tipo de materiales desde bandejas prefabricadas e incluso cartón plano, y con distintos sistemas de envasado: vacío, gas, y skin.



VACUUM CHAMBER MACHINES

MÁQUINAS DE VACÍO

VACUUM · GAS
VACÍO · GAS



Our vacuum chamber machines are the essence and origin of Frimaq. A wide range of table-top machines as well as double chamber machines to meet any production needs.

Nuestras campanas de vacío son la esencia y origen de Frimaq. Una gran variedad de máquinas de sobremesa así como dobles campanas para satisfacer cualquier necesidad de producción.

CHAMBER BELT MACHINES

MÁQUINAS DE VACÍO CON CINTA

VACUUM · SHRINK
VACÍO · RETRÁCTIL

Probably a unique type of machine in the world, our VCC PLUS is a large vacuum chamber for high productions and capacity, capable of working in line offering a customised solution.

Probablemente un tipo de máquina único en el mundo, nuestra VCC PLUS es una gran campana de vacío para altas producciones y capacidades, capaz de trabajar en línea ofreciendo una solución personalizada.



VCC ◀
VCC PLUS

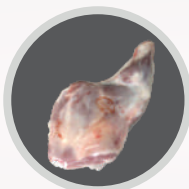
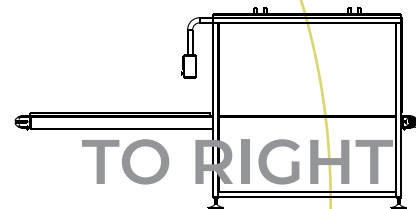
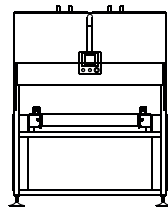
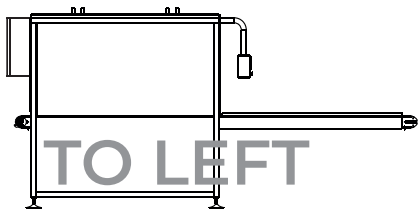

PACKAGING, VACUUM AND FLOW LINE COMBINATION

COMBINACIÓN LINEA COMPLETA DE ENVASADO, VACÍO Y FLOW

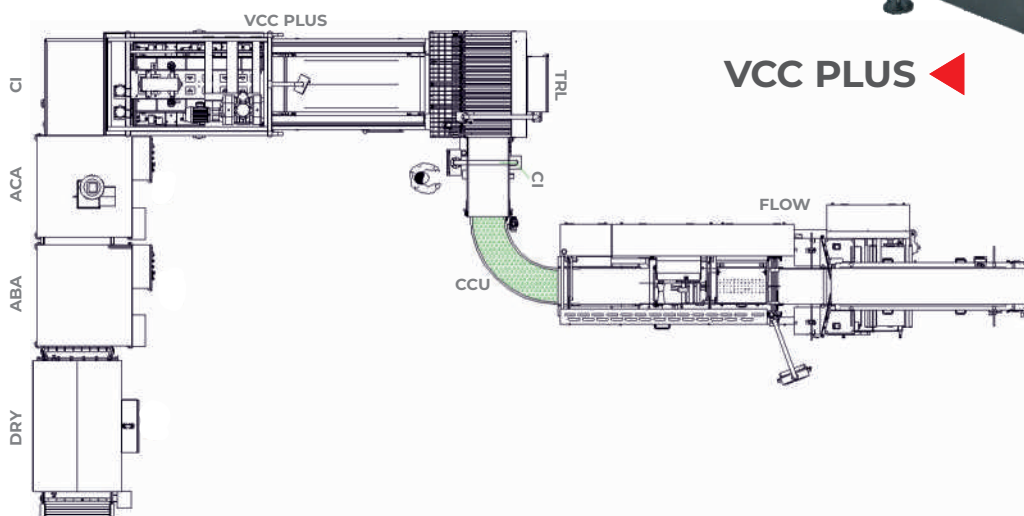
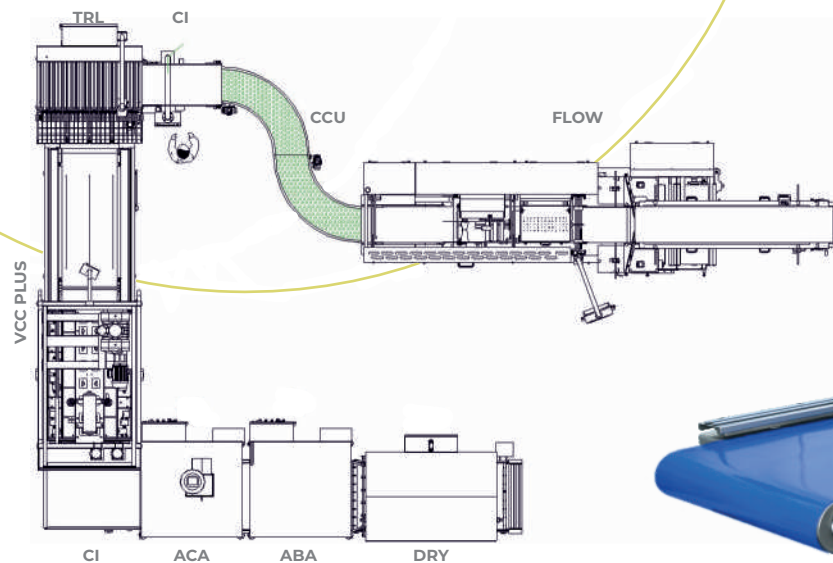

VCC PLUS ◀

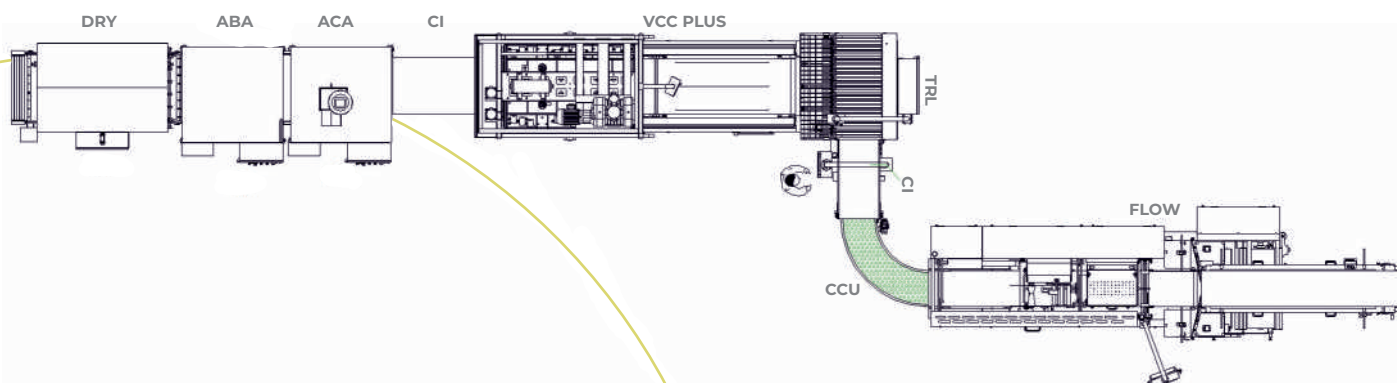

SHRINKING

RETRACTILADORES



COOLER AND DRYER

ENFRIADOR Y SECADOR



PERIPHERAL

PERIFÉRICOS

Frimaq not only produces machinery, but also a wide variety of peripherals that complement any of our machines and packaging lines: aligners, conveyor belts and tray dispensers are just a small sample of what we are capable of.

Frimaq no solo produce maquinaria, sino también una gran variedad y sinfín de periféricos que complementan cualquiera de nuestras máquinas y líneas de envasado: alineadoras, cintas transportadoras y dispensadores de bandejas, son solo una pequeña muestra de todo lo que somos capaces de hacer.

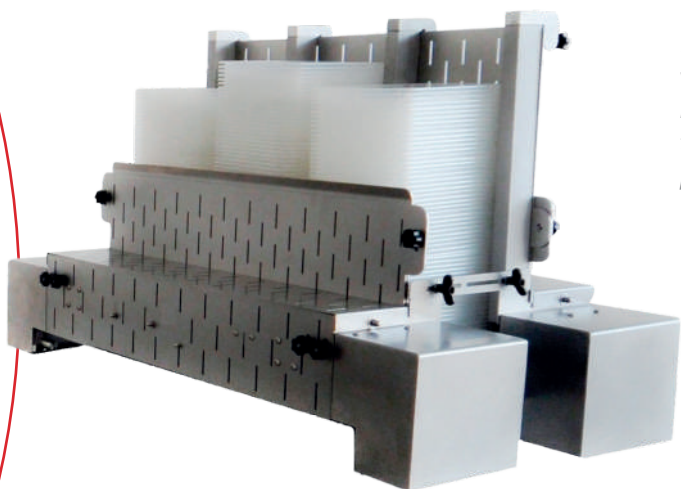

▶ **TRAYS DISPENSER**
DISPENSADOR DE BANDEJAS



▶ **TRAYS ALIGNER**
ALINEADOR DE BANDEJAS

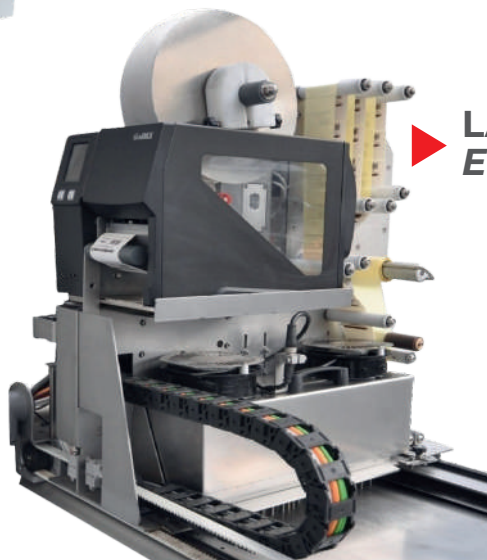

▶ **LABELLER**
ETIQUETADORA

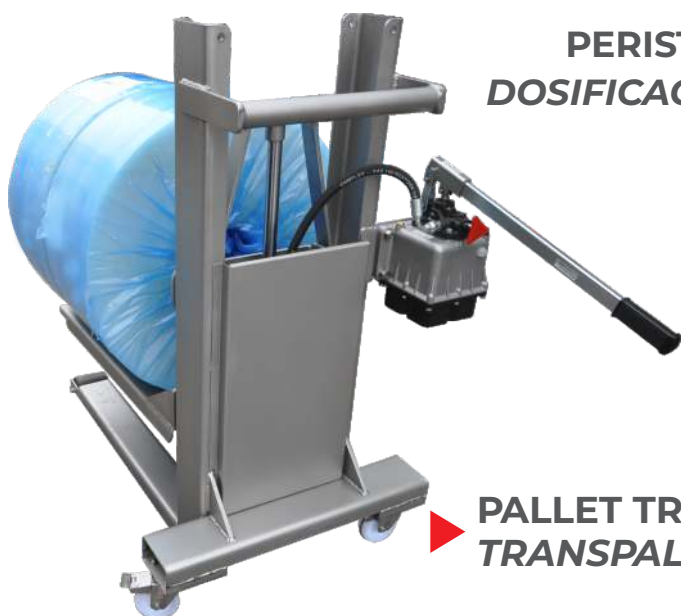

▶ **PERISTALTIC DISPENSER**
DOSIFICADOR PERISTÁLTICO

▶ **PALLET TRUCK**
TRANSPALETA DE BOBINAS

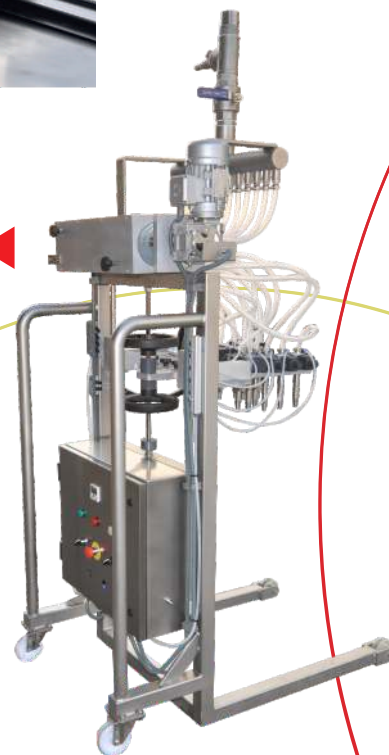

PERIPHERAL

PERIFÉRICOS

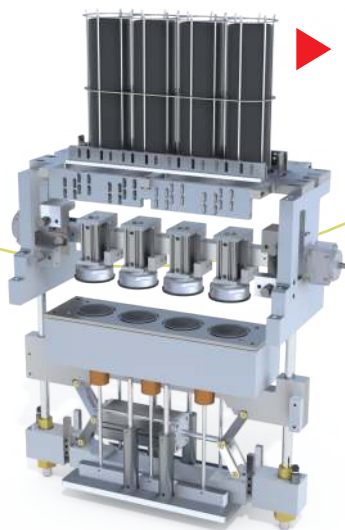

▶ **LIDS PLACEMENT MACHINE**
COLOCADOR DE TAPAS



▶ **CNC FOR TTO PRINTER**
CNC PARA IMPRESORA TTO

▶ **PACKAGES ALIGNER AD-470**
ALINEADOR ENVASES AD-470

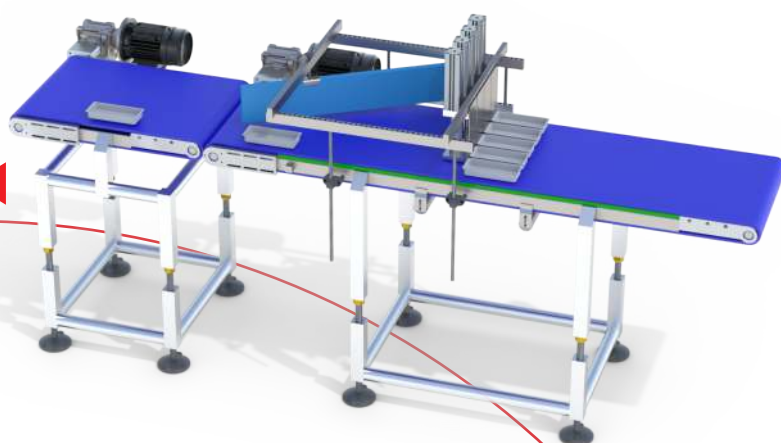

▶ **CURVED CONVEYOR 90° / 180°**
CINTAS CURVAS 90 / 180 °



▶ **ROTATING TABLE MG-1200**
MESA GIRATORIA MG-1200

▶ **REELS LIFTING HOIST**
POLIPASTO ELEVADOR DE BOBINAS





INTERNATIONAL DISTRIBUTION

Frimaq has a powerful network of distributors that encompasses more than 50 countries throughout the planet, being one of the companies in the sector with the largest global presence.

DISTRIBUCIÓN INTERNACIONAL

Frimaq tiene una potente red de distribuidores que engloba a más de 50 países a lo largo de todo el planeta, siendo una de las empresas del sector con mayor presencia mundial.



Frimaq Packaging with the New Packaging Solutions

Cardboard packaging is the present and future of the packaging Industry. From Frimaq we work on adapting our machinery to the new times and demands for more sustainable and eco-friendly packaging.

Frimaq Packaging con las Nuevas Soluciones de Envasado

El envasado en cartón es el presente y futuro del packaging. Desde Frimaq trabajamos para adaptar nuestra maquinaria a las nuevas demandas de un envasado más ecológico, sostenible y amigable con el medio ambiente.





FRIMAQ

 +34 968 407 206

 info@frimaq.com

 www.frimaq.com

Poligono Industrial Saprelorca - Avda. Manuel Martinez Barea, Parcela M-6, Nave 1, Buzón 273
30817 Lorca (Murcia) Spain