



FAST ENDÜSTRİ

ALÜMİNYUM SIGMA TEKNOLOJİLERİ



SİGMA PROFİL SİSTEMLERİ



**Kanal 6
Sigma Profiller**



**Kanal 8
Sigma Profiller**



**Kanal 10
Sigma Profiller**



Konveyör Profili



Tanbur Profilleri



Yüzey Kaplama Profilleri

SİGMA PROFİL SİSTEMLERİ

Kanal 6 Sigma Profilleri

20 x 20 Sigma Profil

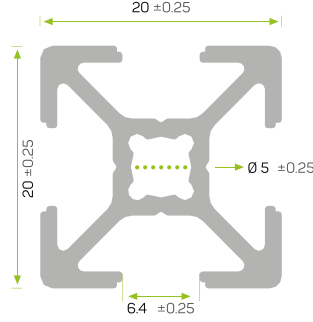

20X20



| | |
|------------------------|------------------------|
| Ağırlık / Weight | 0.387 kg/m |
| Alan / Area | 142.71 mm ² |
| Atalet Momenti - Ix | 0.600 cm ⁴ |
| Atalet Momenti - Iy | 0.600 cm ⁴ |
| Mukavemet Momenti - Wx | 0.600 cm ³ |
| Mukavemet Momenti - Wy | 0.600 cm ³ |

20 x 40 Sigma Profil

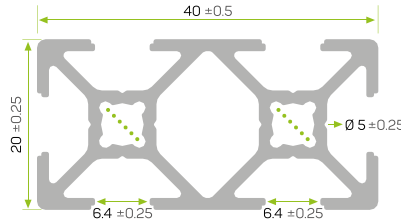

20X40



| | |
|------------------------|------------------------|
| Ağırlık / Weight | 0.699 kg/m |
| Alan / Area | 257.84 mm ² |
| Atalet Momenti - Ix | 1.118 cm ⁴ |
| Atalet Momenti - Iy | 4.066 cm ⁴ |
| Mukavemet Momenti - Wx | 1.118 cm ³ |
| Mukavemet Momenti - Wy | 2.03 cm ³ |

20 x 20 Sigma Profil Raduslu

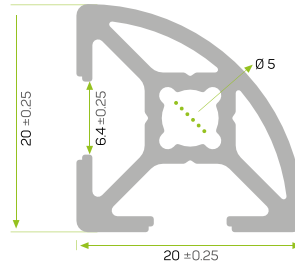

20X20 R



| | |
|------------------------|------------------------|
| Ağırlık / Weight | 0.380 kg/m |
| Alan / Area | 140.17 mm ² |
| Atalet Momenti - Ix | 0.368 cm ⁴ |
| Atalet Momenti - Iy | 0.646 cm ⁴ |
| Mukavemet Momenti - Wx | 0.368 cm ³ |
| Mukavemet Momenti - Wy | 0.646 cm ³ |

25 x 25 Sigma Profil

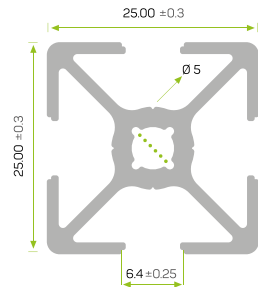

25X25



| | |
|------------------------|------------------------|
| Ağırlık / Weight | 0.569 kg/m |
| Alan / Area | 209.93 mm ² |
| Atalet Momenti - Ix | 1.320 cm ⁴ |
| Atalet Momenti - Iy | 1.320 cm ⁴ |
| Mukavemet Momenti - Wx | 1.056 cm ³ |
| Mukavemet Momenti - Wy | 1.056 cm ³ |

SİGMA PROFİL SİSTEMLERİ

Kanal 8 Sigma Profiller

30 x 30 Sigma Profil Süper Light

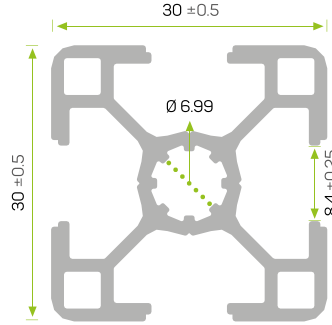

30X30 H



| | |
|------------------------|------------------------|
| Ağırlık / Weight | 0.729 kg/m |
| Alan / Area | 268.94 mm ² |
| Atalet Momenti - Ix | 2.522 cm ⁴ |
| Atalet Momenti - Iy | 2.522 cm ⁴ |
| Mukavemet Momenti - Wx | 1.681 cm ³ |
| Mukavemet Momenti - Wy | 1.681 cm ³ |

30 x 30 Sigma Profil Light

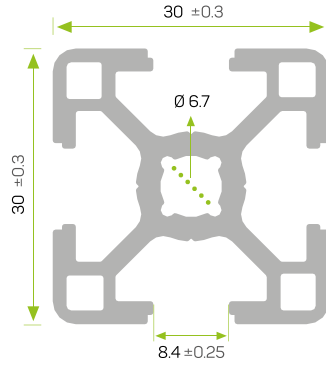

30X30



| | |
|------------------------|------------------------|
| Ağırlık / Weight | 0.882 kg/m |
| Alan / Area | 325.64 mm ² |
| Atalet Momenti - Ix | 2.843 cm ⁴ |
| Atalet Momenti - Iy | 2.843 cm ⁴ |
| Mukavemet Momenti - Wx | 1.895 cm ³ |
| Mukavemet Momenti - Wy | 1.895 cm ³ |

30 x 30 Sigma Profil Kapalı

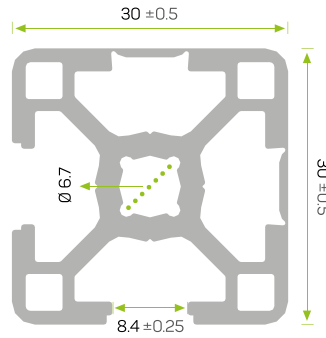
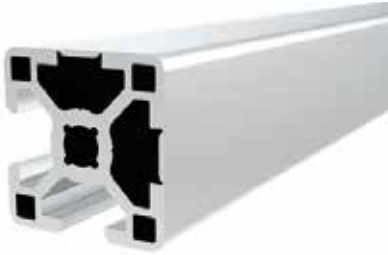

30X30 2K



| | |
|------------------------|------------------------|
| Ağırlık / Weight | 0.918 kg/m |
| Alan / Area | 338.84 cm ² |
| Atalet Momenti - Ix | 2.985 cm ⁴ |
| Atalet Momenti - Iy | 2.977 cm ⁴ |
| Mukavemet Momenti - Wx | 1.990 cm ³ |
| Mukavemet Momenti - Wy | 1.985 cm ³ |

30 x 30 Sigma Profil Raduslu

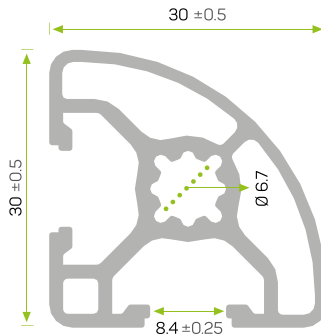

30X30xR



| | |
|------------------------|------------------------|
| Ağırlık / Weight | 0.693 kg/m |
| Alan / Area | 255.75 mm ² |
| Atalet Momenti - Ix | 2.361 cm ⁴ |
| Atalet Momenti - Iy | 1.576 cm ⁴ |
| Mukavemet Momenti - Wx | 1.574 cm ³ |
| Mukavemet Momenti - Wy | 1.051 cm ³ |

SİGMA PROFİL SİSTEMLERİ

Kanal 8 Sigma Profiller

30 x 60 Sigma Profil

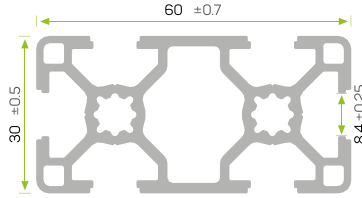

30X60



| | |
|------------------------|------------------------|
| Ağırlık / Weight | 1.516 kg/m |
| Alan / Area | 559.52 mm ² |
| Atalet Momenti - Ix | 5.324 cm ⁴ |
| Atalet Momenti - Iy | 19.789 cm ⁴ |
| Mukavemet Momenti - Wx | 3.549 cm ³ |
| Mukavemet Momenti - Wy | 6.596 cm ³ |

30 x 90 Sigma Profil

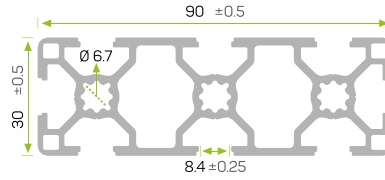

30X90



| | |
|------------------------|------------------------|
| Ağırlık / Weight | 2.145 kg/m |
| Alan / Area | 791.47 mm ² |
| Atalet Momenti - Ix | 7.772 cm ⁴ |
| Atalet Momenti - Iy | 61.018 cm ⁴ |
| Mukavemet Momenti - Wx | 5.181 cm ³ |
| Mukavemet Momenti - Wy | 13.559 cm ³ |

30 x 120 Sigma Profil

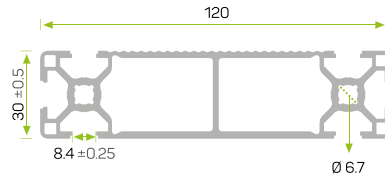

30X120



| | |
|------------------------|-------------------------|
| Ağırlık / Weight | 2.461 kg/m |
| Alan / Area | 908.06 mm ² |
| Atalet Momenti - Ix | 10.836 cm ⁴ |
| Atalet Momenti - Iy | 138.158 cm ⁴ |
| Mukavemet Momenti - Wx | 7.224 cm ³ |
| Mukavemet Momenti - Wy | 23.026 cm ³ |

60 x 60 Sigma Profil Çift Kanal

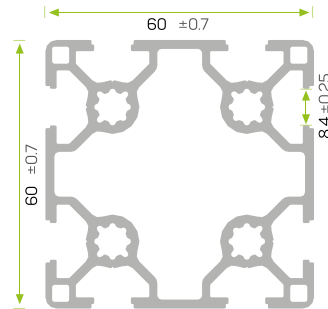

60X60



| | |
|------------------------|------------------------|
| Ağırlık / Weight | 2.413 kg/m |
| Alan / Area | 890.26 mm ² |
| Atalet Momenti - Ix | 35.934 cm ⁴ |
| Atalet Momenti - Iy | 35.938 cm ⁴ |
| Mukavemet Momenti - Wx | 11.978 cm ³ |
| Mukavemet Momenti - Wy | 11.979 cm ³ |

80 x 80 Sigma Profil Ağır

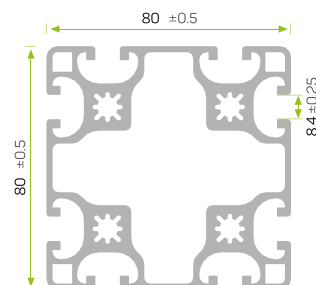

80X80 A



| | |
|------------------------|-------------------------|
| Ağırlık / Weight | 4.821 kg/m |
| Alan / Area | 1778.79 mm ² |
| Atalet Momenti - Ix | 123.558 cm ⁴ |
| Atalet Momenti - Iy | 123.558 cm ⁴ |
| Mukavemet Momenti - Wx | 30.890 cm ³ |
| Mukavemet Momenti - Wy | 30.890 cm ³ |

SİGMA PROFİL SİSTEMLERİ

Kanal 10 Sigma Profiller

40 x 40 Sigma Profil Light

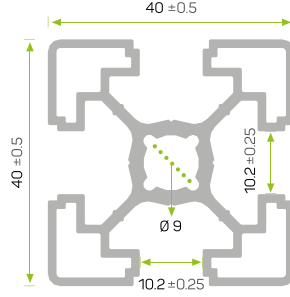

40X40 H



| | |
|------------------------------------|------------------------|
| Ağırlık / Weight | 1.196 kg/m |
| Alan / Area | 441.51 mm ² |
| Atalet Momenti - I _x | 6.739 cm ⁴ |
| Atalet Momenti - I _y | 6.739 cm ⁴ |
| Mukavemet Momenti - W _x | 3.369 cm ³ |
| Mukavemet Momenti - W _y | 3.369 cm ³ |

40 x 40 Sigma Profil Ağır

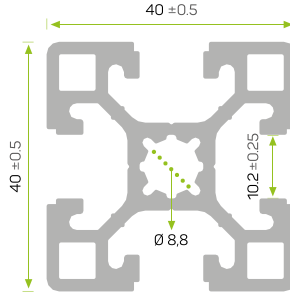

40X40 A



| | |
|------------------------------------|-----------------------|
| Ağırlık / Weight | 1.650 kg/m |
| Alan / Area | 608.9 mm ² |
| Atalet Momenti - I _x | 9.883 cm ⁴ |
| Atalet Momenti - I _y | 9.883 cm ⁴ |
| Mukavemet Momenti - W _x | 4.941 cm ³ |
| Mukavemet Momenti - W _y | 4.941 cm ³ |

40 x 40 Sigma Profil Kapalı

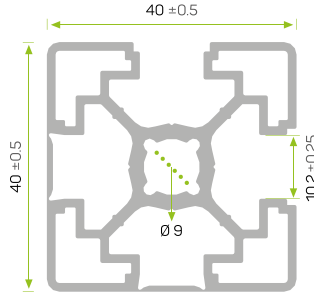

40X40 2K



| | |
|------------------------------------|------------------------|
| Ağırlık / Weight | 1.258 kg/m |
| Alan / Area | 464.36 mm ² |
| Atalet Momenti - I _x | 7.188 cm ⁴ |
| Atalet Momenti - I _y | 7.188 cm ⁴ |
| Mukavemet Momenti - W _x | 3.594 cm ³ |
| Mukavemet Momenti - W _y | 3.594 cm ³ |

40 x 80 Sigma Profil Ağır

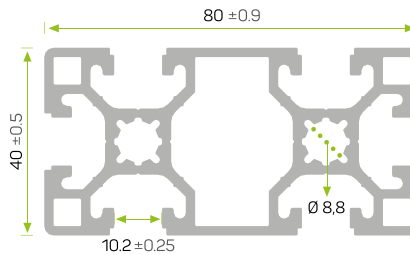

40X80 A



| | |
|------------------------------------|------------------------|
| Ağırlık / Weight | 2.760 kg/m |
| Alan / Area | 1018.5 mm ² |
| Atalet Momenti - I _x | 17.494 cm ⁴ |
| Atalet Momenti - I _y | 68.253 cm ⁴ |
| Mukavemet Momenti - W _x | 8.747 cm ³ |
| Mukavemet Momenti - W _y | 17.063 cm ³ |

40 x 80 Sigma Profil Light

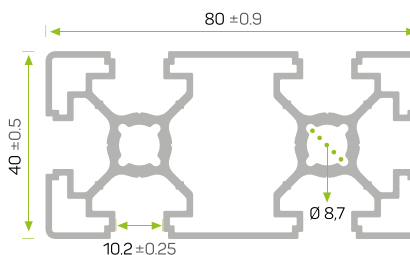

40X80 H



| | |
|------------------------------------|------------------------|
| Ağırlık / Weight | 2.029 kg/m |
| Alan / Area | 748.66 mm ² |
| Atalet Momenti - I _x | 11.937 cm ⁴ |
| Atalet Momenti - I _y | 48.844 cm ⁴ |
| Mukavemet Momenti - W _x | 5.969 cm ³ |
| Mukavemet Momenti - W _y | 12.211 cm ³ |

SİGMA PROFİL SİSTEMLERİ

Kanal 10 Sigma Profiller

40 x 80 Sigma Profil Kapalı

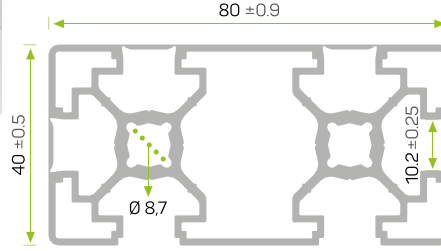

40X80 2K



| | |
|------------------------|------------------------|
| Ağırlık / Weight | 2.122 kg/m |
| Alan / Area | 782.93 mm ² |
| Atalet Momenti - Ix | 12.821 cm ⁴ |
| Atalet Momenti - Iy | 51.569 cm ⁴ |
| Mukavemet Momenti - Wx | 6.411 cm ³ |
| Mukavemet Momenti - Wy | 12.892 cm ³ |

80 x 80 Sigma Profil Ağır

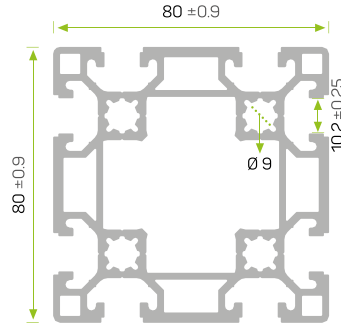

80X80 A



| | |
|------------------------|-------------------------|
| Ağırlık / Weight | 4.885 kg/m |
| Alan / Area | 1802.76 mm ² |
| Atalet Momenti - Ix | 126.755 cm ⁴ |
| Atalet Momenti - Iy | 126.755 cm ⁴ |
| Mukavemet Momenti - Wx | 31.689 cm ³ |
| Mukavemet Momenti - Wy | 31.689 cm ³ |

45 x 45 Sigma Profil Süper Light

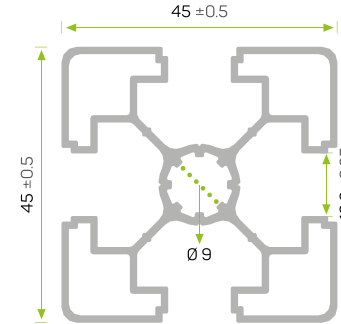

45X45 UH



| | |
|------------------------|------------------------|
| Ağırlık / Weight | 1.127 kg/m |
| Alan / Area | 416.01 mm ² |
| Atalet Momenti - Ix | 8.401 cm ⁴ |
| Atalet Momenti - Iy | 8.401 cm ⁴ |
| Mukavemet Momenti - Wx | 3.734 cm ³ |
| Mukavemet Momenti - Wy | 3.734 cm ³ |

45 x 45 Sigma Profil Light

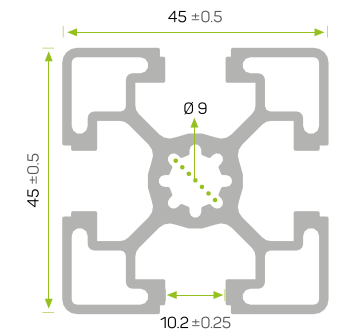

45X45 S



| | |
|------------------------|------------------------|
| Ağırlık / Weight | 1.662 kg/m |
| Alan / Area | 613.31 mm ² |
| Atalet Momenti - Ix | 11.577 cm ⁴ |
| Atalet Momenti - Iy | 11.577 cm ⁴ |
| Mukavemet Momenti - Wx | 5.145 cm ³ |
| Mukavemet Momenti - Wy | 5.145 cm ³ |

45 x 45 Sigma Profil Light

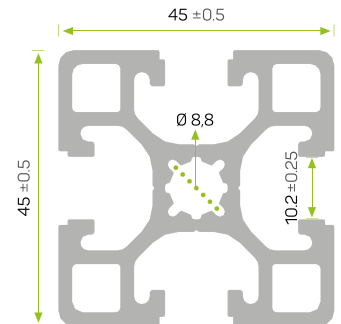

45X45 A



| | |
|------------------------|------------------------|
| Ağırlık / Weight | 2.004 kg/m |
| Alan / Area | 739.47 mm ² |
| Atalet Momenti - Ix | 15.194 cm ⁴ |
| Atalet Momenti - Iy | 15.194 cm ⁴ |
| Mukavemet Momenti - Wx | 6.753 cm ³ |
| Mukavemet Momenti - Wy | 6.753 cm ³ |

SİGMA PROFİL SİSTEMLERİ

Kanal 10 Sigma Profilleri

45 x 45 Sigma Profil Kapalı

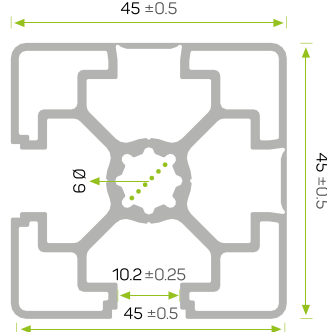
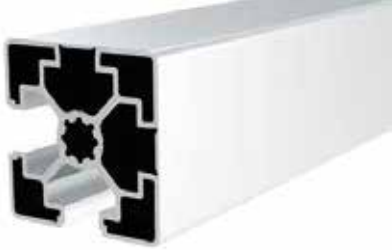

45X45 2K



| | |
|------------------------|------------------------|
| Ağırlık / Weight | 1.403 kg/m |
| Alan / Area | 517.61 mm ² |
| Atalet Momenti - Ix | 10.040 cm ⁴ |
| Atalet Momenti - Iy | 10.040 cm ⁴ |
| Mukavemet Momenti - Wx | 4.462 cm ³ |
| Mukavemet Momenti - Wy | 4.463 cm ³ |

45 x 45 Sigma Profil Raduslu

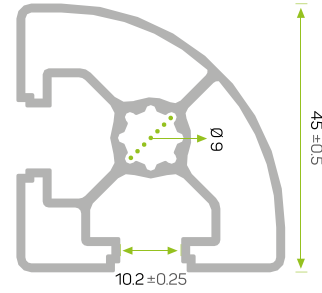

45X45 R



| | |
|------------------------|------------------------|
| Ağırlık / Weight | 1.140 kg/m |
| Alan / Area | 420.66 mm ² |
| Atalet Momenti - Ix | 8.981 cm ⁴ |
| Atalet Momenti - Iy | 6.172 cm ⁴ |
| Mukavemet Momenti - Wx | 3.992 cm ³ |
| Mukavemet Momenti - Wy | 2.743 cm ³ |

60 x 60 Sigma Profil

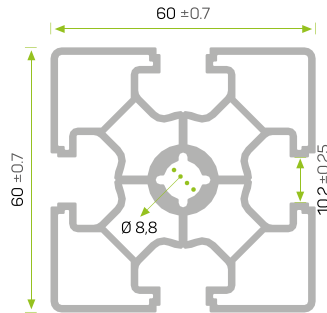

60X60



| | |
|------------------------|------------------------|
| Ağırlık / Weight | 2.509 kg/m |
| Alan / Area | 925.94 mm ² |
| Atalet Momenti - Ix | 29.747 cm ⁴ |
| Atalet Momenti - Iy | 29.747 cm ⁴ |
| Mukavemet Momenti - Wx | 9.916 cm ³ |
| Mukavemet Momenti - Wy | 9.916 cm ³ |

45 x 90 Sigma Profil Light

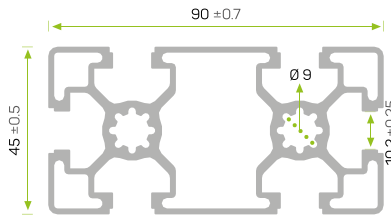

45X90 S



| | |
|------------------------|-------------------------|
| Ağırlık / Weight | 2.792 kg/m |
| Alan / Area | 1030.08 mm ² |
| Atalet Momenti - Ix | 20.590 cm ⁴ |
| Atalet Momenti - Iy | 84.844 cm ⁴ |
| Mukavemet Momenti - Wx | 9.151 cm ³ |
| Mukavemet Momenti - Wy | 18.854 cm ³ |

45 x 90 Sigma Profil Ağır

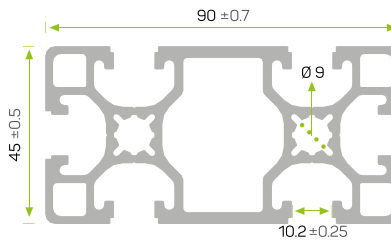

45X90 A



| | |
|------------------------|------------------------|
| Ağırlık / Weight | 3.287 kg/m |
| Alan / Area | 1212.8 mm ² |
| Atalet Momenti - Ix | 27.286 cm ⁴ |
| Atalet Momenti - Iy | 99.516 cm ⁴ |
| Mukavemet Momenti - Wx | 12.127 cm ³ |
| Mukavemet Momenti - Wy | 22.115 cm ³ |

SİGMA PROFİL SİSTEMLERİ

Kanal 10 Sigma Profilleri

45 x 135 Sigma Profil

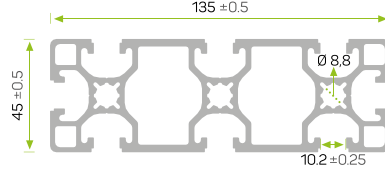

45X135



| | |
|------------------------------------|-------------------------|
| Ağırlık / Weight | 4.686 kg/m |
| Alan / Area | 1729.08 mm ² |
| Atalet Momenti - I _x | 40.242 cm ⁴ |
| Atalet Momenti - I _y | 308.107 cm ⁴ |
| Mukavemet Momenti - W _x | 17.885 cm ³ |
| Mukavemet Momenti - W _y | 45.646 cm ³ |

45 x 180 Sigma Profil

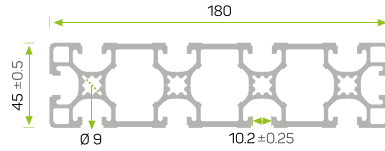

45X180 H



| | |
|------------------------------------|-------------------------|
| Ağırlık / Weight | 6.182 kg/m |
| Alan / Area | 2281.05 mm ² |
| Atalet Momenti - I _x | 52.979 cm ⁴ |
| Atalet Momenti - I _y | 698.163 cm ⁴ |
| Mukavemet Momenti - W _x | 23.546 cm ³ |
| Mukavemet Momenti - W _y | 77.574 cm ³ |

90 x 90 Sigma Profil Light

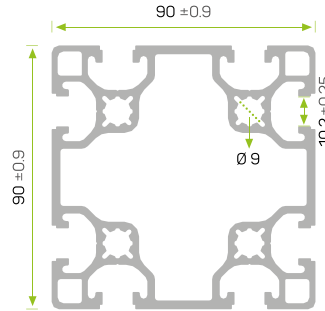

90X90 H



| | |
|------------------------------------|-------------------------|
| Ağırlık / Weight | 5.142 kg/m |
| Alan / Area | 1897.29 mm ² |
| Atalet Momenti - I _x | 179.849 cm ⁴ |
| Atalet Momenti - I _y | 179.849 cm ⁴ |
| Mukavemet Momenti - W _x | 39.966 cm ³ |
| Mukavemet Momenti - W _y | 39.966 cm ³ |

90 x 90 Sigma Profil Ağır

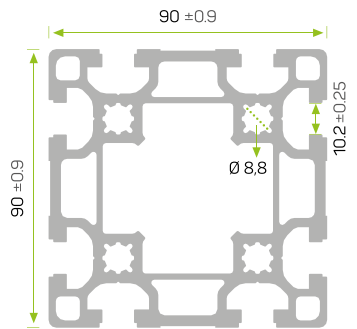

90X90 A



| | |
|------------------------------------|-------------------------|
| Ağırlık / Weight | 6.902 kg/m |
| Alan / Area | 2546.76 mm ² |
| Atalet Momenti - I _x | 223.306 cm ⁴ |
| Atalet Momenti - I _y | 223.306 cm ⁴ |
| Mukavemet Momenti - W _x | 49.623 cm ³ |
| Mukavemet Momenti - W _y | 49.623 cm ³ |

90 x 135 Sigma Profil Ağır

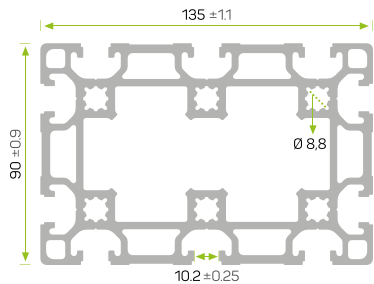

90X135 A



| | |
|------------------------------------|-------------------------|
| Ağırlık / Weight | 9.408 kg/m |
| Alan / Area | 3471.55 mm ² |
| Atalet Momenti - I _x | 317.307 cm ⁴ |
| Atalet Momenti - I _y | 657.173 cm ⁴ |
| Mukavemet Momenti - W _x | 70.513 cm ³ |
| Mukavemet Momenti - W _y | 97.359 cm ³ |

SİGMA PROFİL SİSTEMLERİ

Kanal 10 Sigma Profilleri

90 x 180 Sigma Profil Light

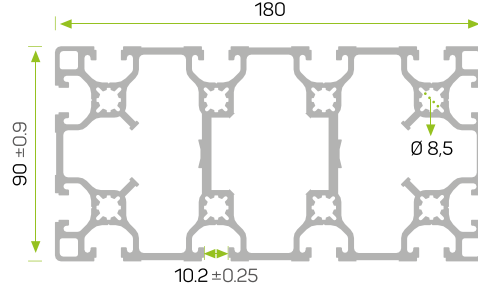

90X180 H



| | |
|------------------------------------|---------------------------|
| Ağırlık / Weight | 9.938 kg/m |
| Alan / Area | 3667.11 mm ² |
| Atalet Momenti - I _x | 347.930 cm ⁴ |
| Atalet Momenti - I _y | 1.220,705 cm ⁴ |
| Mukavemet Momenti - W _x | 77.318 cm ³ |
| Mukavemet Momenti - W _y | 135.634 cm ³ |

Yüzey Kaplama Profilleri

15 x 120 Yüzey Kaplama Profili

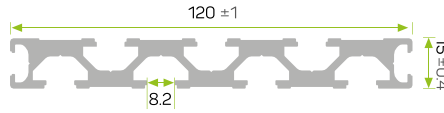

15X120



| | |
|------------------|------------------------|
| Ağırlık / Weight | 2.212 kg/m |
| Alan / Area | 816.14 mm ² |

22,5 x 180 Yüzey Kaplama Profili

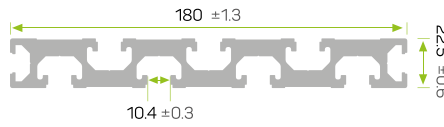

22.5X180 A



| | |
|------------------|------------------------|
| Ağırlık / Weight | 4.13 kg/m |
| Alan / Area | 1522.8 mm ² |

Yan Bariyer Profilleri

40'lık Yan Bariyer Profili

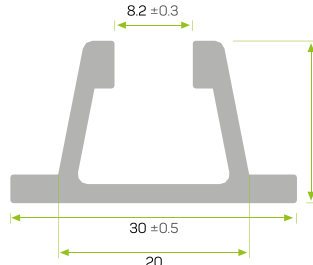

30X17

| | |
|------------------|-----------------------|
| Ağırlık / Weight | 0.357 kg/m |
| Alan / Area | 131.9 mm ² |

60'lık Yan Bariyer Profili

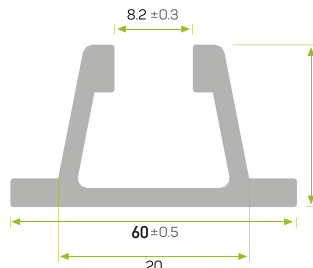

60X17

| | |
|------------------|-----------------------|
| Ağırlık / Weight | 0.77 kg/m |
| Alan / Area | 131.9 mm ² |

SİGMA PROFİL SİSTEMLERİ

Konveyör Profiller

23 x 127 Konveyör Profili

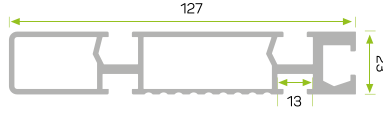

127X23

| | |
|------------------|-----------------------|
| Ağırlık / Weight | 2.196 kg/m |
| Alan / Area | 810.2 mm ² |

23 x 75 Konveyör Profili

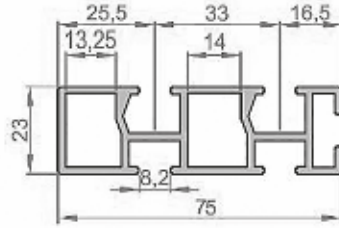
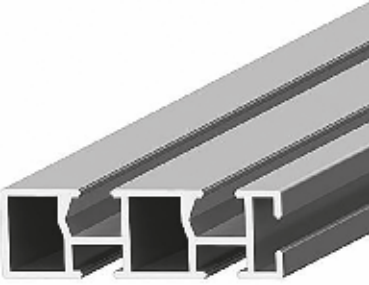

EBAT

| | | |
|------------------------------------|-----------------------|---|
| 23x75 mm | 8 mm | - |
| AĞIRLIK | 1.31 kg/m | |
| ALAN | 649,3 mm ² | |
| ATALET MOMENTİ - I _x | 5,2 cm ⁴ | |
| ATALET MOMENTİ - I _y | 109,6 cm ⁴ | |
| MUKAVEMET MOMENTİ - W _x | 4,5 cm ³ | |
| MUKAVEMET MOMENTİ - W _y | 17 cm ³ | |
| SİPARİŞ KODU | 7496 | |

50 x 1,5 Polisajlı Boru

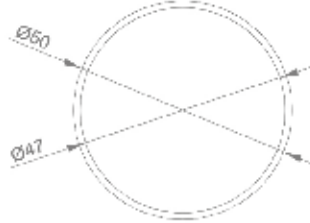

23 x 75 Konveyör Profili

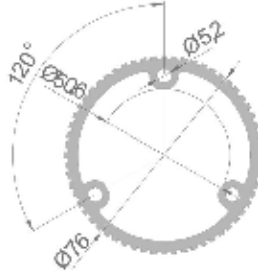

23 x 75 Konveyör Profili

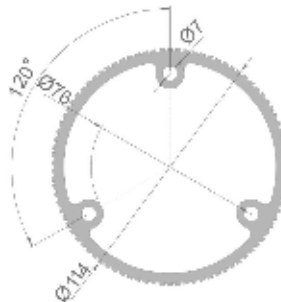

SİGMA PROFİL SİSTEMLERİ

Profil Bağlantı Ekipmanları

□ Düz Köşe Bağlantılar

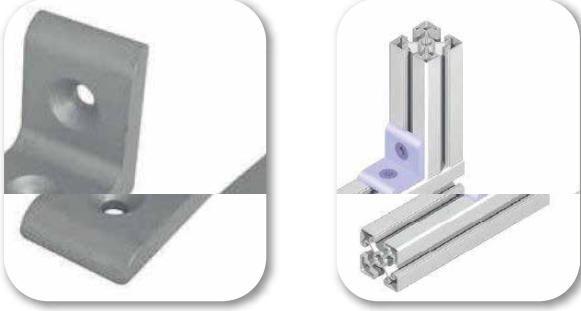

| Ürün Ölçüsü | Kanal Ölçüsü | Civata Ölçüsü |
|-------------|--------------|---------------|
| 30 x 30 | Kanal 8 | M6 |
| 40 x 40 | Kanal 10 | M8 |
| 45 x 45 | Kanal 10 | M8 |
| 80 x 80 | Kanal 10 | M8 |

□ Dar Köşe Bağlantılar



| Ürün Ölçüsü | Kanal Ölçüsü | Civata Ölçüsü |
|-------------|--------------|---------------|
| 30 x 30 | Kanal 8 | M6 |
| 40 x 40 | Kanal 10 | M8 |
| 45 x 45 | Kanal 10 | M8 |

□ Geniş Köşe Bağlantılar

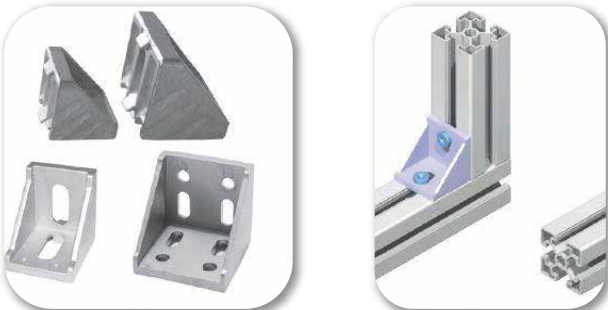

| Ürün Ölçüsü | Kanal Ölçüsü | Civata Ölçüsü |
|-------------|--------------|---------------|
| 20 x 20 | Kanal 6 | M4, M5 |
| 30 x 30 | Kanal 8 | M6 |
| 40 x 40 | Kanal 10 | M8 |
| 45 x 45 | Kanal 10 | M8 |
| 60 x 60 | Kanal 10 | M8 |
| 80 x 80 | Kanal 10 | M8 |
| 90 x 90 | Kanal 10 | M8 |

SİGMA PROFİL SİSTEMLERİ

Profil Bağlantı Ekipmanları

Uzun Köşe Bağlantılar



| Ürün Ölçüsü | Kanal Ölçüsü | Civata Ölçüsü |
|-------------|--------------|---------------|
| 30 x 60 | Kanal 8 | M6 |
| 40 x 80 | Kanal 10 | M8 |
| 45 x 90 | Kanal 10 | M8 |

Kare (Küp) Köşe Bağlantılar

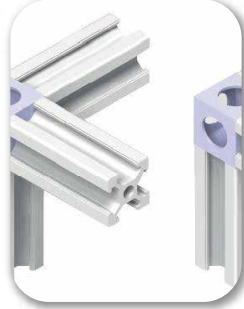

| Ürün Ölçüsü | Kanal Ölçüsü | Civata Ölçüsü | Bağlantı Yönü |
|-------------|--------------|---------------|---------------|
| 30 x 30 | Kanal 8 | M6 | 3 Yönlü |
| 40 x 40 | Kanal 10 | M8 | 3 Yönlü |
| 45 x 45 | Kanal 10 | M8 | 3 Yönlü |

Düz Bağlantı Sacları



| Ürün Açıklaması | 30 x 30 | 40 x 40 | 45 x 45 |
|-----------------|---------|---------|---------|
| İki Yönlü | ● | ● | ● |
| Üç Yönlü | ● | ● | ● |

Dereceli Bağlantı Sacları



| Ürün Ölçüsü | 90 Derece | 120 Derece | 135 Derece |
|-------------|-----------|------------|------------|
| 30 x 30 | ● | ● | ● |
| 40 x 40 | ● | ● | ● |
| 45 x 45 | ● | ● | ● |

SİGMA PROFİL SİSTEMLERİ

Profil Bağlantı Ekipmanları

Çektirme Tip Bağlantıları



Alın Cıvataları

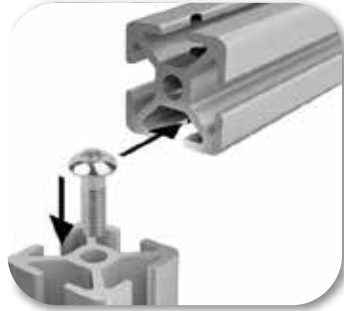

| Ürün Ölçüsü | Kanal Ölçüsü | Civata Ölçüsü |
|-------------|--------------|---------------|
| M6 x 20 | Kanal 6 | M6 |
| M8 x 25 | Kanal 8 | M8 |
| M10 x 30 | Kanal 10 | M8 |

İmbus Cıvatalar



| Dış Ölçüsü | 8 mm | 10 mm | 12 mm | 16 mm | 20 mm | 25 mm | 30 mm | 40 mm | 50 mm |
|------------|------|-------|-------|-------|-------|-------|-------|-------|-------|
| M4 | ● | ● | ● | ● | ● | | | | |
| M5 | | ● | ● | ● | ● | | | | |
| M6 | | | ● | ● | ● | ● | | | |
| M8 | | | ● | ● | ● | ● | ● | ● | ● |
| M10 | | | | | | | ● | | |

Havşa Başlı Cıvatalar



| Dış Ölçüsü | 8 mm | 10 mm | 12 mm | 16 mm | 20 mm | 25 mm | 30 mm |
|------------|------|-------|-------|-------|-------|-------|-------|
| M4 | ● | | | ● | | | |
| M5 | | ● | ● | ● | | | |
| M6 | | | ● | ● | ● | | |
| M8 | | | ● | ● | ● | ● | |
| M10 | | | | | | | ● |

SİGMA PROFİL SİSTEMLERİ

Profil Bağlantı Ekipmanları

❑ Tırtıllı Somunlar



| Kanal Ölçüsü | M4 | M5 | M6 | M8 |
|--------------|----|----|----|----|
| Kanal 6 | ● | ● | | |
| Kanal 8 | ● | ● | ● | |
| Kanal 10 | | ● | ● | ● |

❑ T Kanal Somunları



| Kanal Ölçüsü | M5 | M6 | M8 |
|--------------|----|----|----|
| Kanal 8 | ● | ● | |
| Kanal 10 | | ● | ● |

❑ Dikdörtgen Somunlar



| Kanal Ölçüsü | M6 | M8 |
|--------------|----|----|
| Kanal 8 | ● | ● |

❑ Kare Somunlar



| Kanal Ölçüsü | M8 | M10 |
|--------------|----|-----|
| Kanal 10 | ● | ● |

SİGMA PROFİL SİSTEMLERİ

Profil Aksesuarları

□ Sigma Profil Kapakları

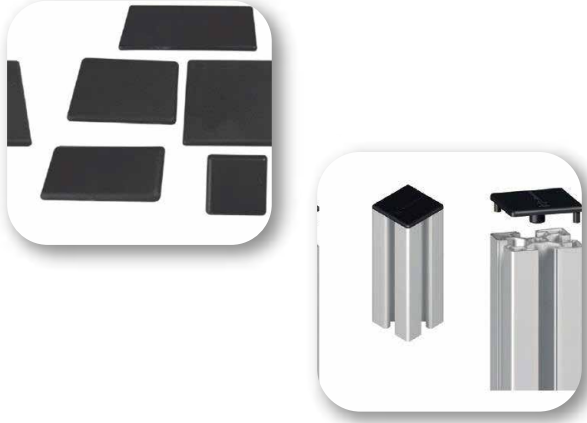

| Profil Ölçüsü | Siyah | Gri | Profil Ölçüsü | Siyah | Gri |
|---------------|-------|-----|---------------|-------|-----|
| 30 x 30 | ● | ● | 45 x 45 | ● | ● |
| 30 x 60 | ● | ● | 45 x 90 | ● | ● |
| 30 x 90 | ● | ● | 80 x 80 | ● | ● |
| 40 x 40 | ● | ● | 90 x 90 | ● | ● |
| 40 x 80 | ● | ● | 23 x 127 | ● | ● |

□ Sigma Profil Kanal Fitilleri

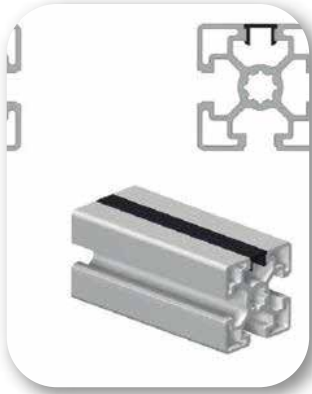

| Kanal Ölçüsü | Şeffaf | Siyah | Gri | Mavi | Kırmızı |
|--------------|--------|-------|-----|------|---------|
| Kanal 6 | ● | ● | ● | ● | ● |
| Kanal 8 | ● | ● | ● | ● | ● |
| Kanal 10 | ● | ● | ● | ● | ● |

□ Sigma Profil Cam Fitilleri



| Kanal Ölçüsü | Şeffaf | Siyah | Mavi | Kırmızı |
|--------------|--------|-------|------|---------|
| Kanal 6 | ● | ● | ● | ● |
| Kanal 8 | ● | ● | ● | ● |
| Kanal 10 | ● | ● | ● | ● |

SİGMA PROFİL SİSTEMLERİ

Profil Aksesuarları

❑ Pleksiglass Camlar

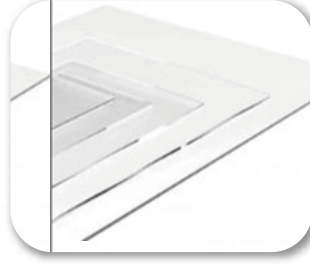
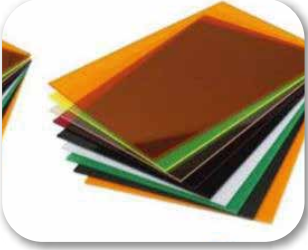

| Kalınlık Ölçüsü | 3 mm | 5 mm | 8 mm |
|-----------------|------|------|------|
| Şeffaf | ● | ● | ● |
| Beyaz | ● | ● | ● |
| Siyah | ● | ● | ● |
| Açık Mavi | ● | ● | ● |
| Füme | ● | ● | ● |

❑ Plastik & Zamak Mentешeler



| Kanal Ölçüsü | 30 x 30 | 40 x 40 | 45 x 45 |
|--------------|---------|---------|---------|
| Kanal 8 | ● | | |
| Kanal 10 | | ● | ● |

❑ Kulplar



| Ürün Tanımı | L (mm) | D (mm) |
|-------------|--------|--------|
| Kulp – 01 | 116 | 10 |
| Kulp – 02 | 138 | 10 |

| Ürün Tanımı | Siyah | Yeşil | Sarı | Turuncu |
|-------------|-------|-------|------|---------|
| Kulp – 01 | ● | ● | ● | ● |
| Kulp – 02 | ● | ● | ● | ● |

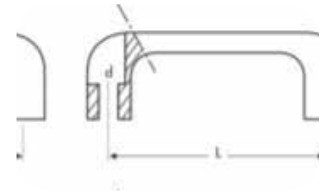

SİGMA PROFİL SİSTEMLERİ

Sigma Profil Aksesuarları

Plastik Ayaklar



| Çap Ölçüsü | M8 | M10 | M12 | M16 |
|------------|----|-----|-----|-----|
| Ø 50 mm | ● | ● | ● | ● |

Standart Metal Ayaklar



| Çap Ölçüsü | M10 | M12 | M16 |
|------------|-----|-----|-----|
| Ø 50 mm | ● | ● | ● |
| Ø 80 mm | ● | ● | ● |
| Ø 100 mm | ● | ● | ● |

Tekerlek



| Çap Ölçüsü | FRENSİZ | FRENLİ |
|------------|---------|--------|
| Ø 50 mm | ● | ● |
| Ø 75 mm | ● | ● |
| Ø 100 mm | ● | ● |

SİGMA PROFİL SİSTEMLERİ

Sigma Profil Aksesuarları

□ Ayak Bağlantı Parçaları



| Diş Ölçüsü | 30 x 60 | 40 x 40 | 40 x 80 | 45 x 45 | Diş Ölçüsü | 45 x 90 | 60 x 60 | 80 x 80 | 90 x 90 |
|------------|---------|---------|---------|---------|------------|---------|---------|---------|---------|
| M8 | ● | ● | ● | ● | M8 | ● | ● | ● | ● |
| M10 | | ● | ● | ● | M10 | ● | ● | ● | ● |
| M12 | | | ● | | M12 | ● | ● | ● | ● |
| M16 | | | ● | | M16 | | | ● | ● |

□ Kabin Kilitleri



| Bilyalı Kilit Ölçüsü | Kanal Ölçüsü | Mıknatıslı Kilit Ölçüsü | Kanal Ölçüsü |
|----------------------|--------------|-------------------------|--------------|
| 30 x 30 | K8 | 30 x 30 | K8 |
| 40 x 40 | K10 | 40 x 40 | K10 |
| 45 x 45 | K10 | 45 x 45 | K10 |

□ Kanal Sürgü Setleri



| Kanal Ölçüsü | Ray | Tekerlek |
|--------------|-----|----------|
| Kanal 8 | ● | ● |
| Kanal 10 | ● | ● |

□ Kelebek Topuzlar

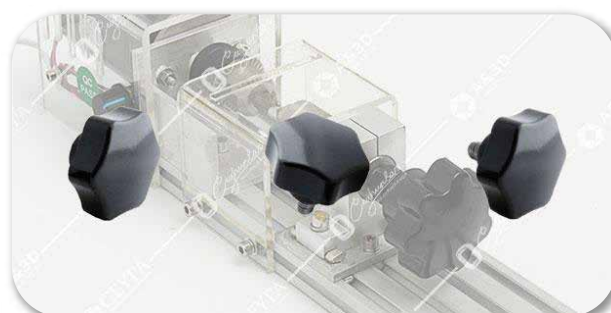

| Ürün Ölçüsü | Ø30 | Ø40 |
|-------------|-----|-----|
| M6 | ● | ● |
| M8 | ● | ● |
| M8 | ● | ● |

KONVEYÖR SİSTEMLERİ



KONVEYÖR SİSTEMLERİ

Konveyör Ekipmanları

☐ Gergi – Tahrik Plakaları

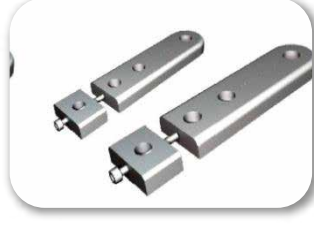

| Profil Ölçüsü | Gergi Plakası | Tahrik Plakası |
|---------------|---------------|----------------|
| 45 x 45 | ● | ● |
| 30 x 60 | ● | ● |
| 23 x 75 | ● | ● |
| 45 x 90 | ● | ● |
| 23 x 75 | ● | ● |
| 25 x 105 | ● | ● |
| 23 x 127 | ● | ● |

☐ Gergi – Tahrik Tamburları



| Tambur Ölçüsü | 40 | 85 | 130 | 150 | 175 | 200 | 300 |
|---------------|----|----|-----|-----|-----|-----|-----|
| Ø 45 | ● | ● | ● | ● | ● | ● | ● |
| Ø 76 | | | | | | | ● |
| Ø 114 | | | | | | | ● |



| Tambur Ölçüsü | 450 | 600 | 800 | 1000 | 1500 | Özel Ölçü |
|---------------|-----|-----|-----|------|------|-----------|
| Ø 45 | ● | | | | | ● |
| Ø 76 | ● | ● | ● | ● | | ● |
| Ø 114 | ● | ● | ● | ● | ● | ● |

SİGMA PROFİL SİSTEMLERİ

Konveyör Ekipmanları

Avare Rulolar



| Tambur Ölçüsü | 300 | 450 | 600 | 800 | 1000 |
|----------------|-----|-----|-----|-----|------|
| Ø 45 Tırtıllı | ● | ● | ● | ● | ● |
| Ø 50 Alüminyum | ● | ● | ● | ● | ● |
| Ø 51 Çelik | ● | ● | ● | ● | ● |

Rulo Yatakları - Alt Rulo - Dönüş Rulo Yatağı

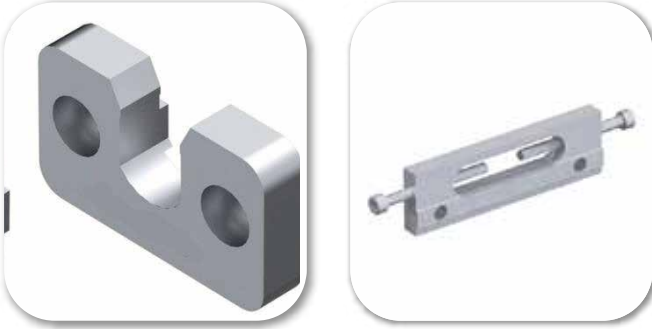

| Tambur Ölçüsü | Rulo Yatak |
|----------------|------------|
| Ø 45 Tırtıllı | ● |
| Ø 50 Alüminyum | ● |
| Ø 51 Çelik | ● |

Tork Kolları



| Redüktör Ölçüsü | EV 30 | EV 40 | EV 50 |
|-----------------|-------|-------|-------|
| Kaplamalı Sac | ● | ● | ● |
| Paslanmaz Sac | ● | ● | ● |

Gergi Somunu



Gergi Civatası



SİGMA PROFİL SİSTEMLERİ

Profil Aksesuarları

☐ Konveyör Bağlantı Sacları



Konveyör Bağlantı Sacları

3 mm HRP

Düz Bağlantı Sacı



T Bağlantı Sacı



Dereceli Bağlantı Sacı



☐ Konveyör Üçlü Ayak



☐ Ayak Bağlantı Parçası



☐ Yan Bağlantı Parçası

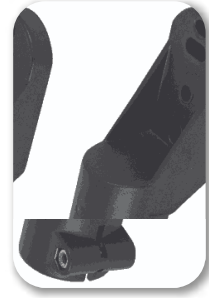

☐ Konsol Çapraz Tutucu

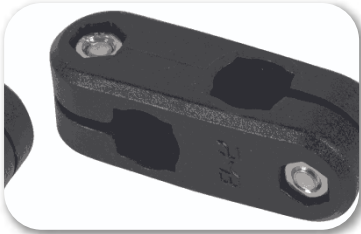

☐ Sensör Tutucu



☐ Gövde Bağlantı Mengenesi



☐ Çiftli Mil Tutucu



☐ Tekli Mil Tutucu



☐ Konsol Bağlantı Mili

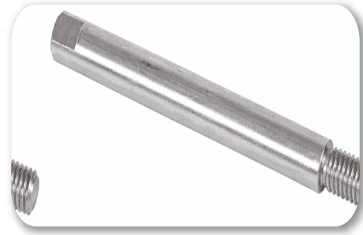

☐ Konsol Bağlantı Takımı



KONVEYÖR SİSTEMLERİ

Konveyör Ekipmanları

60'lık Yan Bariyer Plastiđi

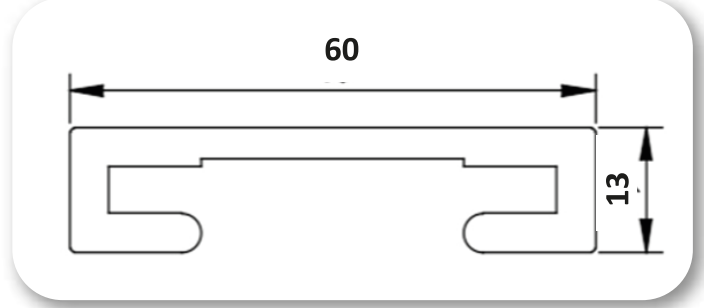
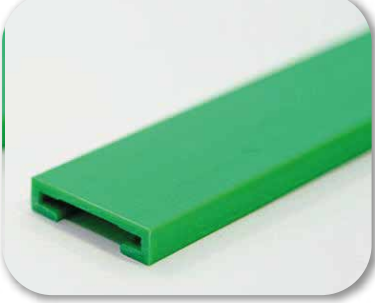

40'lık Yan Bariyer Plastiđi

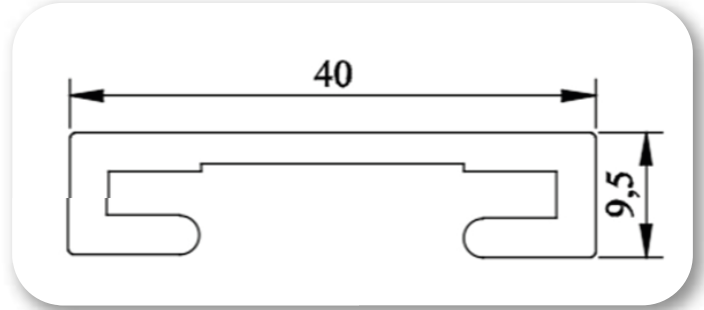

Konveyör Bant Çeşitleri

PVC ve Poliüretan Bant Çeşitleri

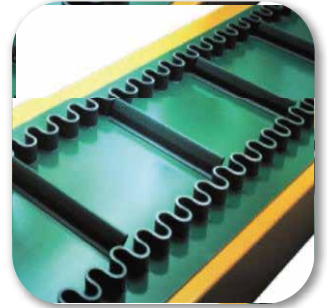

Asetal Bant



Modüler Bant Çeşitleri



MEKATRONİK SİSTEMLERİ



MEKATRONİK SİSTEMLERİ

Hazır Otomasyon Panoları

Konveyör Hız Kontrol Panoları



İşe Özel Otomasyon Panoları



Motorlar

Asenkron Motorlar



| Devir Güç | 0,09 Kw | 0,18 Kw | 0,25 Kw | 0,37 Kw | 0,55 Kw | 0,75 Kw | 1,1 Kw | 1,5 Kw |
|------------|---------|---------|---------|---------|---------|---------|--------|--------|
| 1500 Devir | ● | ● | ● | ● | ● | ● | ● | ● |
| 3000 Devir | ● | ● | ● | ● | ● | ● | ● | ● |

Servo Motorlar



| Güç | Frenli | Frensiz |
|---------|--------|---------|
| 0,40 Kw | ● | ● |
| 0,75 Kw | ● | ● |

Enkoderli Step Motorlar



| Güç | 0,5 Nm | 2 Nm | 2,2 Nm | 3 Nm | 4,5 Nm |
|-----|--------|------|--------|------|--------|
| | ● | ● | ● | ● | ● |

MEKATRONİK SİSTEMLERİ

Asenkron ve Servo Sürücüler

Asenkron Sürücüler



| Marka | Danfoss | Delta | Wecon |
|---------|--------------------------|--------------------------|--------------------------|
| 0,37 Kw | <input type="checkbox"/> | <input type="checkbox"/> | <input type="checkbox"/> |
| 0,75 Kw | <input type="checkbox"/> | <input type="checkbox"/> | <input type="checkbox"/> |
| 1,1 Kw | <input type="checkbox"/> | <input type="checkbox"/> | <input type="checkbox"/> |
| 1,5 Kw | <input type="checkbox"/> | <input type="checkbox"/> | <input type="checkbox"/> |

Servo Sürücüler



Hibrit Step Sürücüler



| Marka | Delta | Wecon |
|---------|--------------------------|--------------------------|
| 0,40 Kw | <input type="checkbox"/> | <input type="checkbox"/> |
| 0,75 Kw | <input type="checkbox"/> | <input type="checkbox"/> |

| Güç | 0,5 Nm | 2 Nm | 2,2 Nm | 3 Nm | 4,5 Nm |
|-----|--------------------------|--------------------------|--------------------------|--------------------------|--------------------------|
| | <input type="checkbox"/> | <input type="checkbox"/> | <input type="checkbox"/> | <input type="checkbox"/> | <input type="checkbox"/> |

MEKATRONİK SİSTEMLERİ

Redüktörler

Sonsuz Dişli Redüktörler



| Tahvil Oranı | EN 30 | EN 40 | EN 50 |
|--------------|-------|-------|-------|
| i:5 | ● | ● | ● |
| i:10 | ● | ● | ● |
| i:15 | ● | ● | ● |
| i:20 | ● | ● | ● |
| i:30 | ● | ● | ● |

Planet Redüktörler



| Tahvil Oranı | 40 Gövde | 60 Gövde | 80 Gövde |
|--------------|-------------|-------------|-------------|
| i:5 | ● | ● | ● |
| i:10 | ● | ● | ● |

Güç Kaynakları



| Güç | 15 Watt | 100 Watt | 150 Watt | 350 Watt |
|---------|------------|-------------|-------------|-------------|
| 5 V DC | ● | ● | ● | ● |
| 24 V DC | ● | ● | ● | ● |

Tepe Lambaları



| Güç | 2 Katlı | 3 Katlı |
|---------|------------|------------|
| ∅ 52 mm | ● | ● |

MEKATRONİK SİSTEMLERİ

BUTONLAR

□ 0-1 Kalıcı Butonlar



□ Potansiyometre



□ Acil Stop Butonu



□ Korumalı Acil Stop Butonu



□ HMI Panel (7")



Unit : mm , error range:±0.5mm

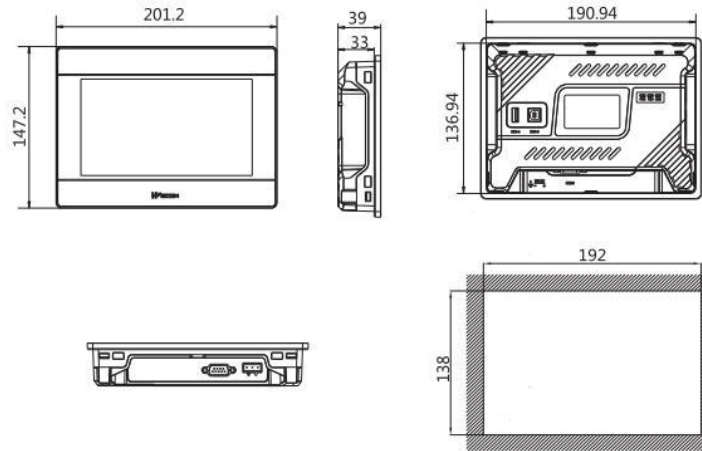

PI3070i installation size

MEKATRONİK SİSTEMLERİ

Sensörler

❑ M18 Cısmiden Yansımali Sensör



❑ M18 Endüktif Sensör



❑ Cısmiden Yansımali Kübik Sensör



❑ Emniyet için Işık Bariyeri



❑ Fiber Optik Sensör ve Amfisi





YOĞUN KULLANIM ALANLARI

AREAS OF USAGE

Conveyors



MONTAJ MASALARI

Assembly Tables



AKTARMA SİSTEMLERİ

Transfer Systems

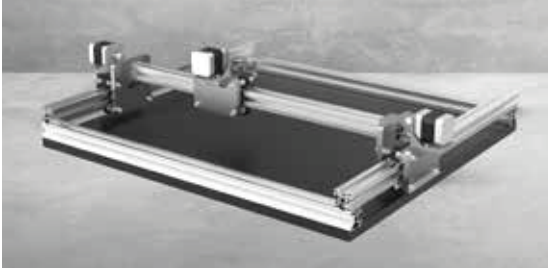

DOLAPLAR

Cabinets



MAKİNE KORUMA KAFESLERİ

Machine Guards Cages

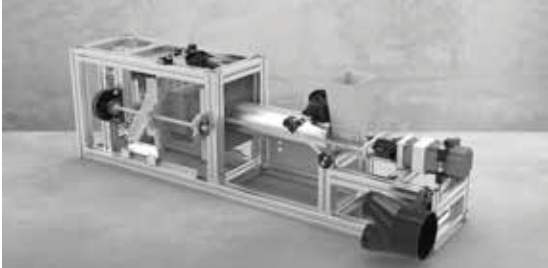

İŞ İSTASYONLARI

Workstation



KABİNLER

Cabins



ÇERÇEVELER

Frames

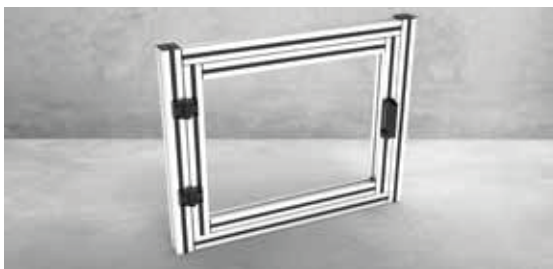

FAST ENDÜSTRİ

ALÜMİNYUM SIGMA TEKNOLOJİLERİ

□ Sigma Profil Sistemleri



□ Konveyör Sistemleri



□ Mekanik Ürünler



□ Mekatronik Sistemler



FAST Endüstri San. Tic. Ltd. Şti.

İ.O.S.B. Süleyman Demirel Bulvarı Sinpaş İş Modern San. Sit. J Blok No:41 Başakşehir / İSTANBUL

0 (212) 843 64 08 – 0 (552) 882 53 83

www.fastendustri.com

info@fastendustri.com

satis@fastendustri.com