

DÜNYANIN MAKİNASI
BİR ARADA

ALEMİNSAN MAKİNE
www.aleminsan.com.tr

Yafes ALEMİN
CEO

T: +90 216 394 31 32
G: +90 532 795 55 89
F: +90 216 394 34 28
Mesit Mah. İlim Sk. No: 1 Orhanlı
Tuzla / İstanbul / Türkiye

ALEMİN SAN
MAKİNE DANIŞMANLIK HİZMETLERİ

ben website
ya@aleminsan.com.tr
e-mail
www.aleminsan.com.tr

ANGLI
扬力集团

Otomatik Alüminyum Folyo
Tabak Makinesi

Intelligent 60-80
High Speed times / minute

ALEMİNSAN



ALM **ALEMİNSAN MAKİNE** **ALM**
www.aleminsan.com.tr

ben website
ya@aleminsan.com.tr
e-mail

ANGLI 扬力集团

SilverEngineer
银工机械

TÜRKİYE DİSTRİBÜTÖRÜ ALÜMİNYUM FOLYO TABAK İMALAT HATTI

YAFES ALEMİN



BÜLENT ALEMİN



MERT ALEMİN



DOĞUKAN ALEMİN





ALEMİNSAN MAKİNE
www.aleminsan.com.tr

Yafes ALEMİN
CEO

T: +90 216 394 31 32
G: +90 532 795 55 89
F: +90 216 394 34 28
Mesit Mah. İlim Sk. No: 1 Orhanlı
Tuzla / İstanbul / Türkiye



YETKİLİ SATIŞ EKİBİMİZ BÜLENT ALEMİN YAFES ALEMİN MERT ALEMİN DOĞUKAN ALEMİN

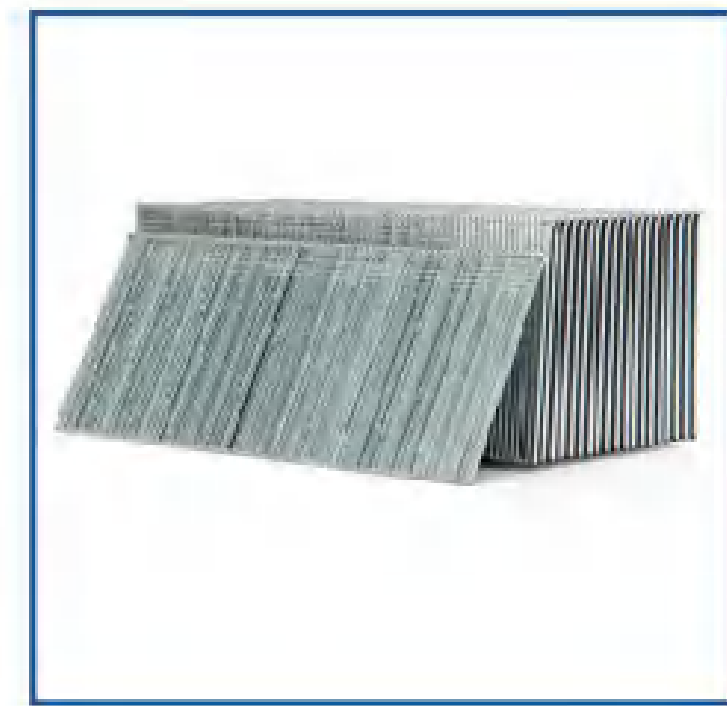

产品型号: F钉
线材 φ: 1.02-1.03mm
厚度: 0.82-0.83mm
产品用途: 木制家具、固定牵引、修理站台、木屋、连接箱子、盒子等钉合。
适用钉枪: 直钉枪
规格型号: F10/F15 /F20/F25/F30

Product model: F nail
Wire φ: 1.02-1.03mm
Thickness: 0.82 to 0.83mm
Product use: wooden furniture, fixed traction, repair platform, wooden house, connecting boxes, boxes, etc.
Nail gun: straight nail gun
Specification : F10/F15 /F20/F25/F30



产品型号: T钉
线材 φ: 1.40mm
厚度: 1.15-1.16mm
产品用途: 木制家具、固定牵引、修理站台、木屋、连接箱子、盒子等钉合。
适用钉枪: 直钉枪
规格型号: T25/T32/T45/T57/T64(不常用)

Product model: T nail
Wire φ: 1.40mm
Thickness: 1.15 to 1.16mm
Product use: wooden furniture, fixed traction, repair platform, wooden house, connecting boxes, boxes, etc.
Nail gun: straight nail gun
Specification : T25/T32/T45/T57/T64(Uncommonly used)



产品型号: N钉
线材 φ: 1.45-1.46mm
厚度: 1.15-1.16mm
产品用途: 装饰、家具、围栏、木屋顶、木盒、箱体包装等钉合。
规格型号: N13 (825) /N15 (832) /N17 (838) /N19 (845) /N21 (850)

Product model: N nail
Wire φ: 1.45-1.46mm
Thickness: 1.15 to 1.16mm
Product use: decoration, furniture, fence, wooden roof, wooden box, box packaging etc.
Specifications: N13 (825) /N15 (832) /N17 (838) /N19 (845) /N21 (850)



产品型号: 4K系列码钉
线材 φ: 1.19-1.20mm
厚度: 0.94-1.0mm
产品用途: 家具制造业中对沙发椅上沙发布或皮的连接, 装潢业用于天花板、薄板等。
适用钉枪: 适合各种牌子钉枪, 如美特。
规格型号: 422K/428K/432K/438K

Product model: 4K series staple nail
Wire φ: 1.19-1.20mm
Thickness: 0.94 to 1.0mm
Product use: Furniture manufacturing industry for sofa and chair sand release or leather connection, upholstery for ceiling, thin plate and so on.
Suitable for nail gun: suitable for various brands of nail gun, such as Mette.
Specification: 422K/428K/432K/438K

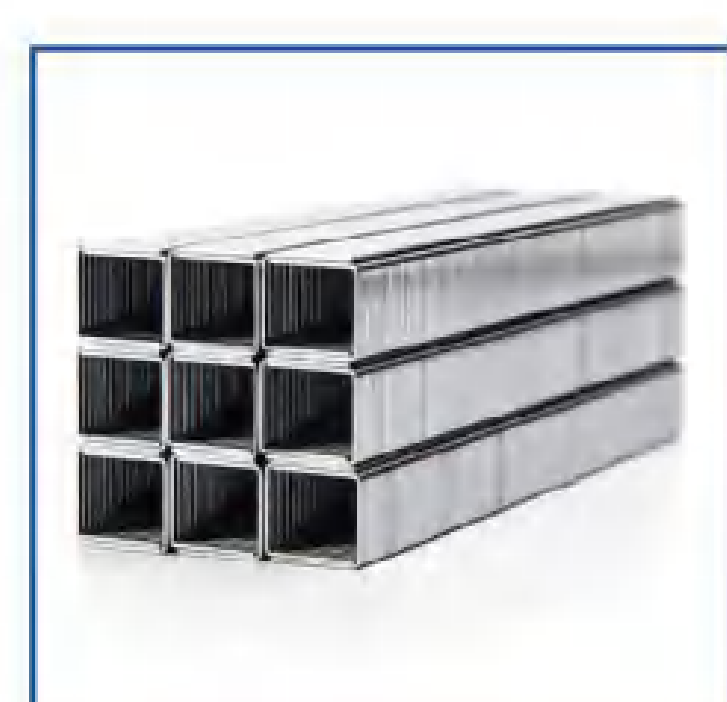

产品型号: 10J系列钉
线材 φ: 0.88mm
厚度: 0.54-0.56mm
产品用途: 室内家具与装饰、铺设地板、连接横梁和各种框架、固定牵引等。
规格型号: 1006J/1008J/1010J/1013J/1016J

Product model: 10J series staple nails
Wire φ: 0.88mm
Thickness: 0.54 to 0.56mm
Product use: indoor furniture and decoration, laying floor, connecting beam and various frames, fixed traction, etc.
Specifications: 1006j / 1008j / 1010j / 1013j / 1016j



型号: 4J码钉
线材 φ: 0.88mm
厚度: 0.54-0.56mm
产品用途: 装饰、家具、门窗、箱框、围栏、木屋顶、木盒、制鞋、皮革及用于其他钉合。
规格型号: 404J、405J、406J、408J、410J、413J、416J、419J、422J

Model: 4J staple nail
Wire φ: 0.88mm
Thickness: 0.54 to 0.56mm
Product use: decoration, furniture, doors and Windows, boxes, fences, wooden roof, wooden box, shoes, leather and other stitching.
Specifications: 404J, 405J, 406J, 408J, 410J,



细木工装潢制作
Joinery packaging production



篱笆固定
Fixed the fence



沙发布料的钉合
The stitching of the fabric on the sofa



钉货架
Nail shelves





ALEMINSAN MAKİNE
www.aleminsan.com.tr

Yafes ALEMİN
CEO

T: +90 216 394 31 32
G: +90 532 795 55 89
F: +90 216 394 34 28
Mescit Mah. İlim Sk. No: 1 Orhanlı
Tuzla / İstanbul / Türkiye

ALEMİN SAN
SOĞUK TEL ÇEKME

ALEMİN SAN
KANEPE VE KOLTUK MEKANİZMA SİSTEMLERİ

ALEMİN SAN
SOĞUK ÇEKME LAMA

YETKİLİ SATIŞ EKİBİMİZ BÜLENT ALEMİN YAFES ALEMİN MERT ALEMİN DOĞUKAN ALEMİN

气排钉主要用于制造气动钉产品，其适用于各种装潢装修、木制家具、造鞋业等行业。该气动钉经专用气动工具连续击打，将其打入木材，是目前唯一取代传统手锤打铁的先进产品。能使以上各行业数倍地提高生产效率，节省劳动力，加快工作进度。

Pneumatic staple pin is mainly used for manufacturing pneumatic nail products, which is suitable for all kinds of decoration, wooden furniture, shoe industry and other industries. The pneumatic nail is continuously hit by special pneumatic tools to drive it into wood, which is the only advanced product to replace the traditional hand hammer. Can make the above industries several times to improve production efficiency, save labor, speed up the progress of work.

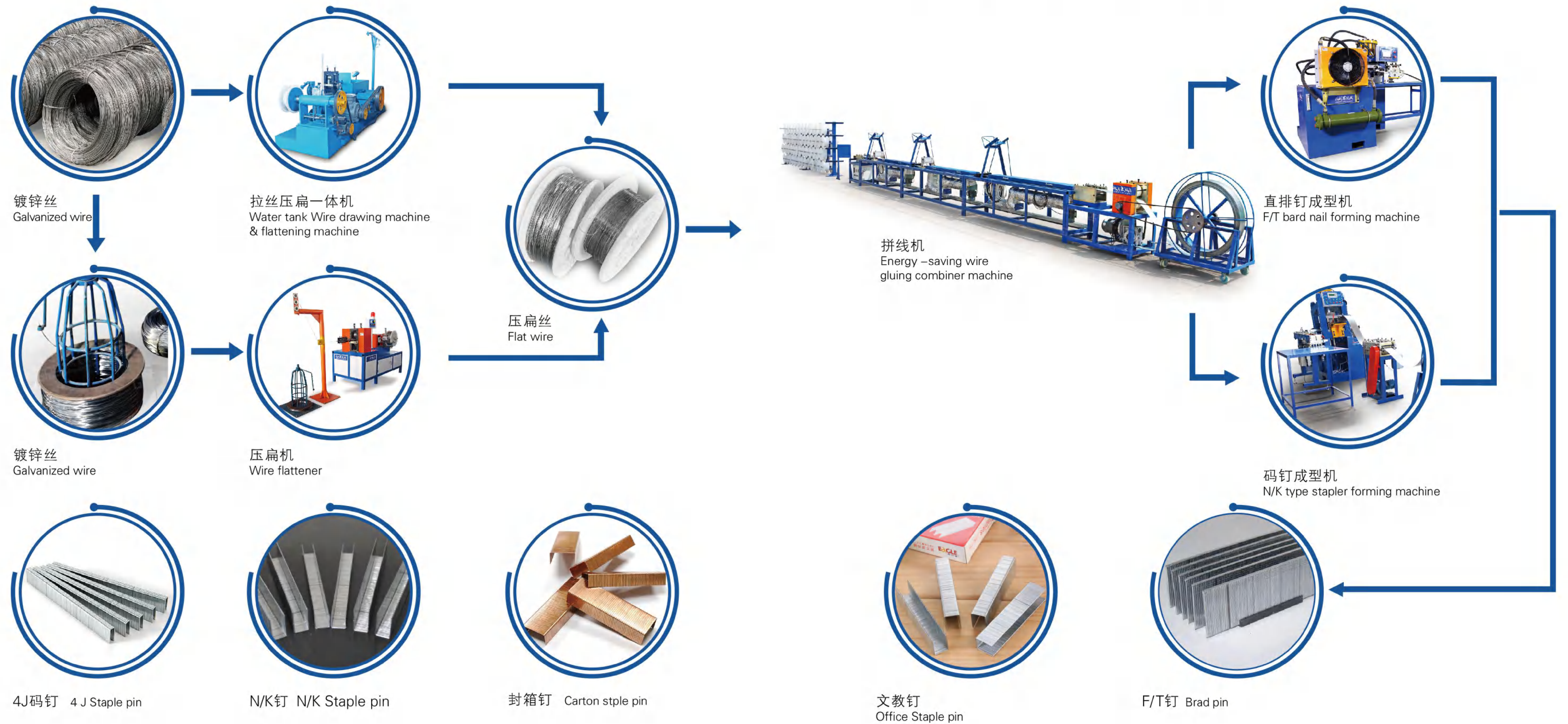

用于上胶拼线，制作成线板，再将线板制造成各种气动钉类产品。

Used for gluing line, made into wire band, and then the wire band into a variety of pneumatic nail products.



ALEMİNSAN MAKİNE
www.aleminsan.com.tr

Yafes ALEMİN
CEO

T: +90 216 394 31 32
G: +90 532 795 55 89
F: +90 216 394 34 28
Mesat Mah. İlim Sk. No: 1 Orhanlı
Tuzla / İstanbul / Türkiye

ALEMİN SAN
SOĞUK TEL ÇEKME

ALEMİN SAN
KANEPE VE KOLTUK MEKANİZMA SİSTEMLERİ

ALEMİN SAN
SOĞUK ÇEKME LAMA

YETKİLİ SATIŞ EKİBİMİZ BÜLENT ALEMİN YAFES ALEMİN MERT ALEMİN DOĞUKAN ALEMİN

压扁机 (标准型压扁机)
Wire flattener (Standard flattening machine)

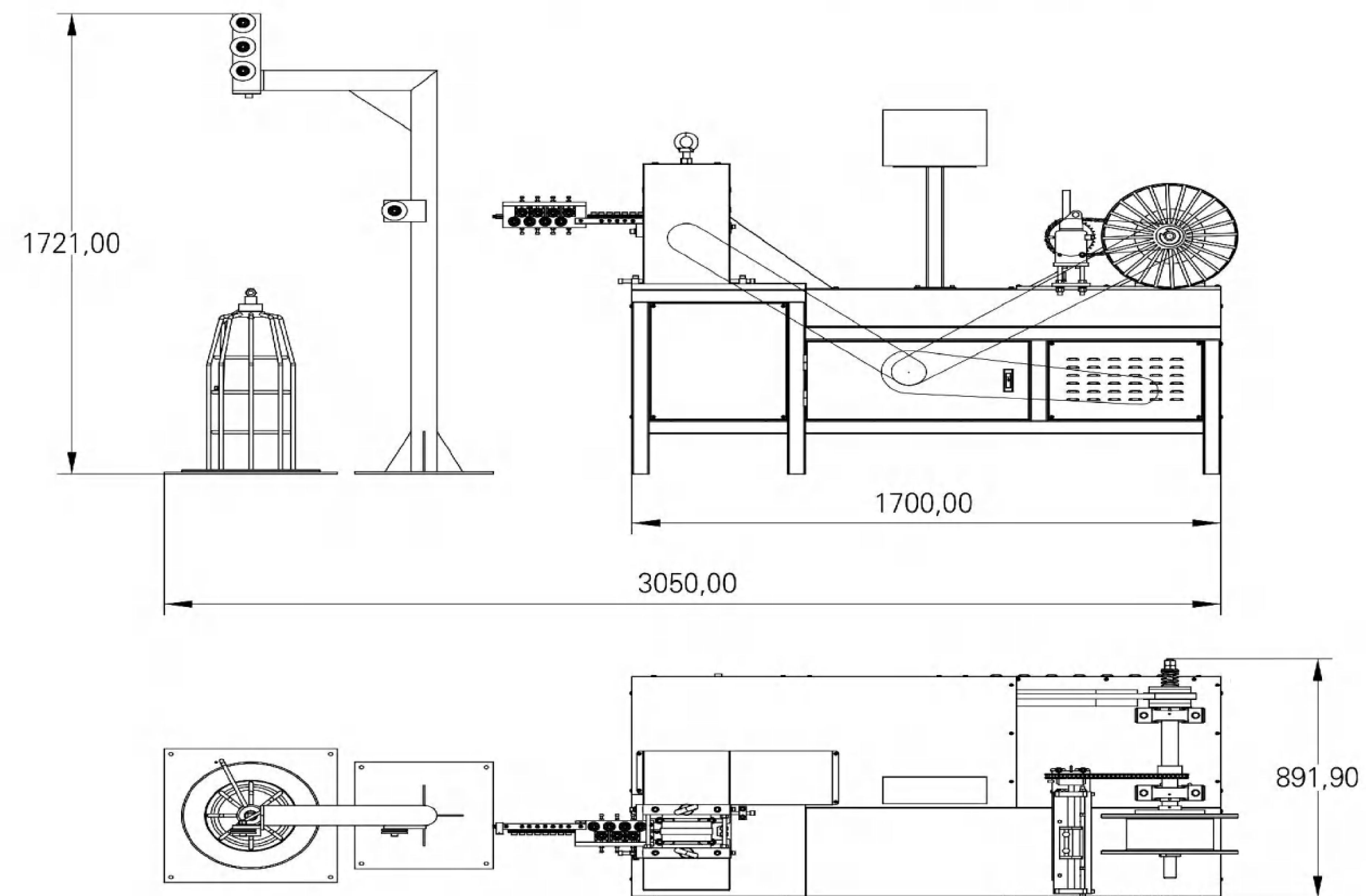

Wire flattener
(Double wheel flattening machine)



功能描述 Function:

采用硬度高合金进口材质压轮, 保证压扁精度, 配备高精度自动摆线器, 保证收线均匀, 整机可采用电磁调速变频调速。

It adopts high hardness alloy wheel, to make sure flatter accuracy. It is equipped with high accuracy automatic cycloid, to make sure rewinding uniform, The whole machine can use electromagnetic or frequency speed control.

| | |
|---------------------------|---|
| 功率Motor power | 4kW (双压扁) 4KW (Double pressed) 3kW (单压扁) 3KW (Single flattening) |
| 速度Speed | 10-350 m/min |
| 压线范围Wire flattening range | 0.4-2mm |
| 重量Weight | 500KG |
| 外形尺寸Dimension (L/W/H) | 2500*1100*1800mm |

水箱式拉丝压扁机
Water tank wire drawing & flattening machine



功能描述 Function:

本机为拉丝及压扁功能一体机, 压轮可配备Φ150mm或Φ200mm水冷却压轮随意选择, 整机采用变频器同步控制速度, 配备高精度自动摆线器。

This machine has wire drawing and flattening function together. Flatten wheel can be Φ150mm or Φ200mm. The whole machine adoptd frequency converter synchronous control speed, equipped with high precision automatic cycloid.

| | |
|---------------------------|------------------|
| 功率Motor power | 30+2.2KW |
| 速度Speed | 10-450 m/min |
| 压线范围Wire flattening range | 0.4-2.2mm |
| 重量Weight | 2000KG |
| 外形尺寸Dimension (L/W/H) | 2800*1500*1800mm |



ALEMINSAN MAKİNE
www.aleminsan.com.tr

Yafes ALEMİN
CEO

T: +90 216 394 31 32
G: +90 532 795 55 89
F: +90 216 394 34 28
Mesit Mah. İlim Sk. No: 1 Orhanlı
Tuzla / İstanbul / Türkiye



YETKİLİ SATIŞ EKİBİMİZ BÜLENT ALEMİN YAFES ALEMİN MERT ALEMİN DOĞUKAN ALEMİN

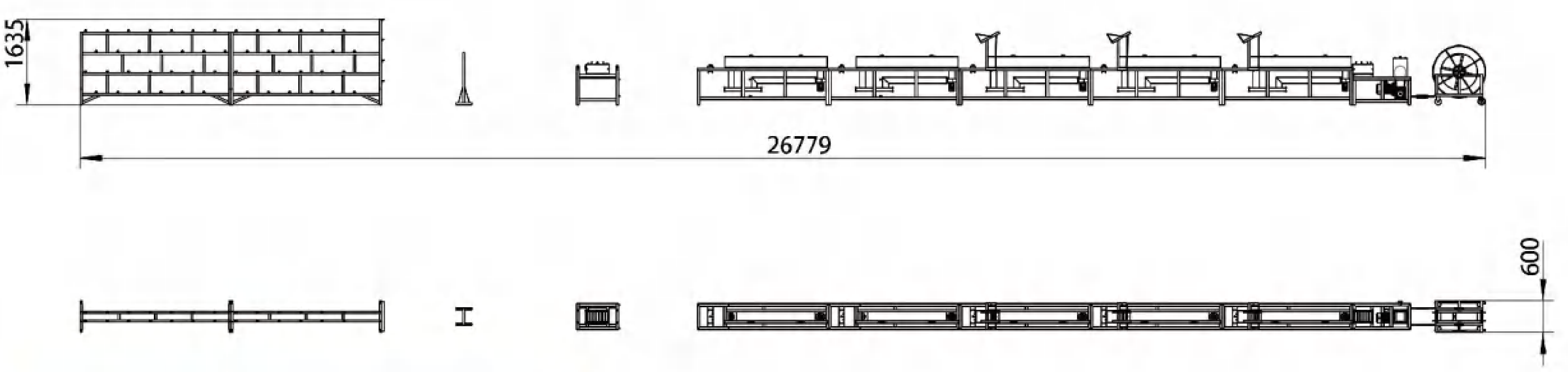

功能描述Function:

电磁型加热上胶拼线机是一种风冷、水冷双冷却系统设备，高效节能，可加装断丝自动停车功能的节能式上胶拼线机。设备总长可根据客户需求来设定。

Electromagnetic heating gluing and stitching machine is a kind of air cooling and water cooling double cooling system equipment, high efficiency and energy saving, can be equipped with broken wire automatic stop function of energy-saving gluing and stitching machine. Total length of equipment can be set according to customer requirements.

| | |
|-------------------------|------------------|
| 功率 Motor power | 18KW |
| 速度 Speed | 6-20m/min |
| 拼线宽度 Combining width | 50-150mm |
| 重量 Weight | 1500KG |
| 外形尺寸 Dimension | 2500*1000*1700mm |

F/T brad pin nail forming machine

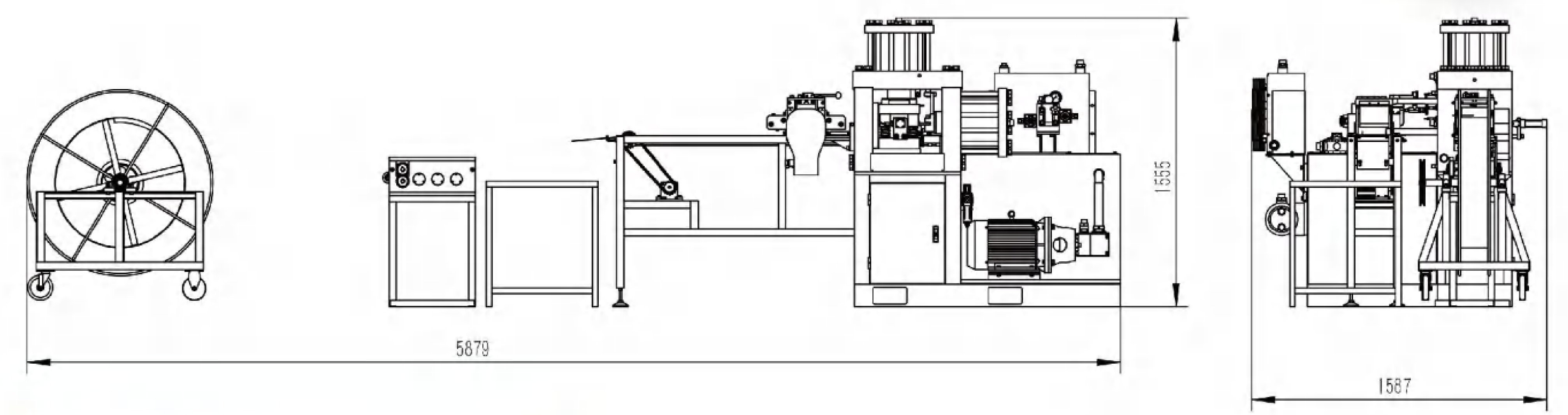

功能描述Function:

采用加大液压油罐设计，采用日本三菱PLC可编程控制器，加厚主体机身墙板，采用台湾进口电磁换向阀，风、水冷却系统，伺服电机送料，触摸屏控制，专业生产F/T钉。

It uses thick hydraulic oil tank and Japan Mitsubishi PLC Programmable controller. Thicken machine wall plate. Adopts Taiwan Solenoid directional valve. It is specialized for producing F/T staple.

F新型液压直排钉成型机

| | |
|---------------|------------------|
| 功率Motor power | 5.5KW |
| 速度Speed | 100-150 pcs/min |
| 重量Weight | 1100KG |
| 外形尺寸Dimension | 1700*1700*1500mm |

F/T新型液压直排钉成型机、斜排钉成型机

| | |
|---------------|------------------|
| 功率Motor power | 5.5+2.3KW |
| 速度Speed | 100-140 pcs/min |
| 重量Weight | 1200KG |
| 外形尺寸Dimension | 1700*1700*1500mm |



ALEMINSAN MAKİNE
www.aleminsan.com.tr

Yafes ALEMİN
CEO

T: +90 216 394 31 32
G: +90 532 795 55 89
F: +90 216 394 34 28
Mescit Mah. İlim Sk. No: 1 Orhanlı
Tuzla / İstanbul / Türkiye

YETKİLİ SATIŞ EKİBİMİZ BÜLENT ALEMİN YAFES ALEMİN MERT ALEMİN DOĞUKAN ALEMİN

本机摒弃了传统的重型冲床，采用液压系统为执行部件，利用PLC微电脑集中控制，具有操作安全、性能稳定、噪音小等特点，比传统的冲床成型机打钉的速度大幅度提高。

This machine abandoned the traditional heavy punch, using oil pressure system as the executive parts, using PLC microcomputer centralized control, with safe operation, stable performance, low noise and other characteristics, compared with the traditional punch forming machine nail-punching speed greatly improved.

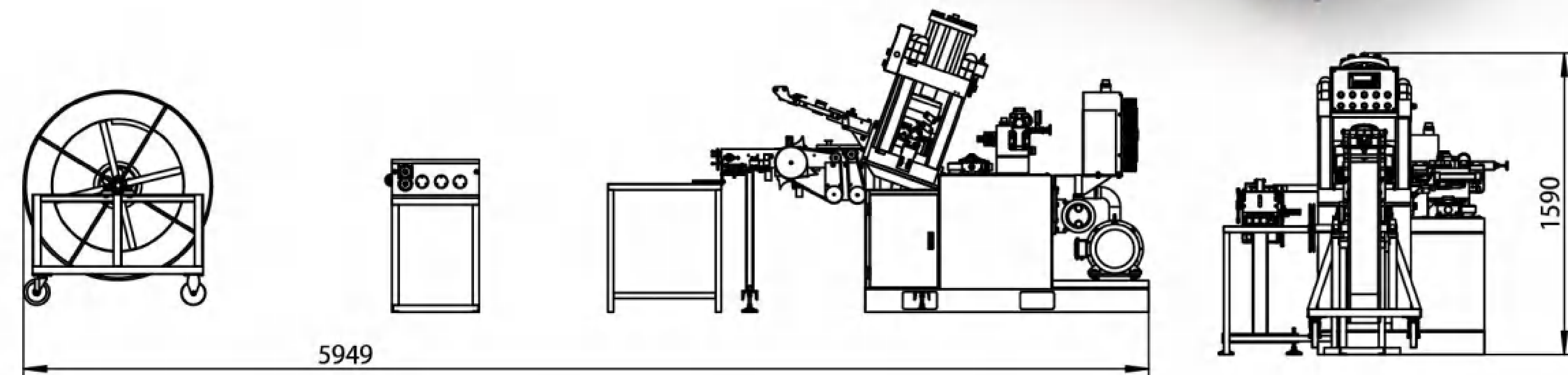
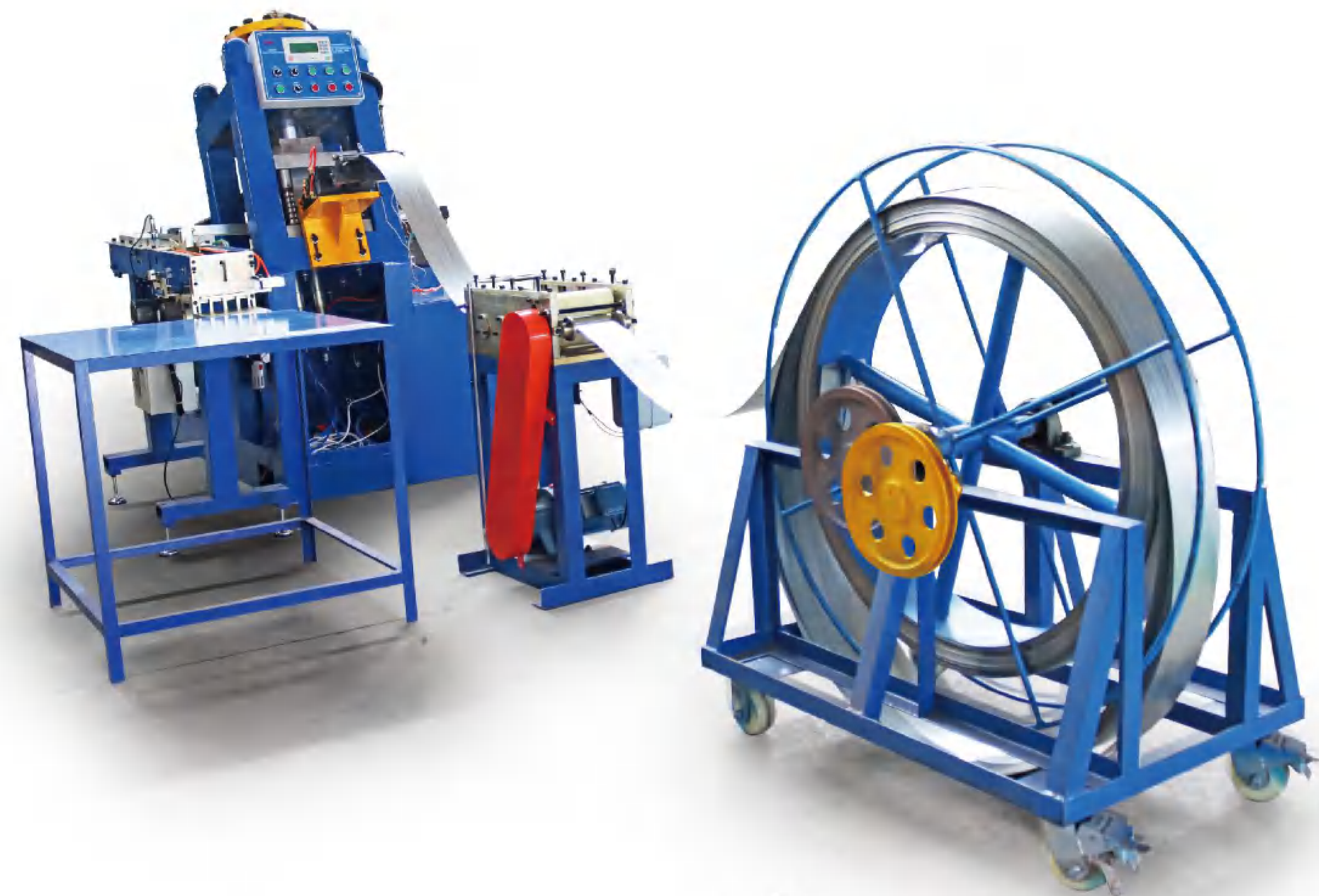

N、K型成型机N、K type forming machine

| | |
|---------------|------------------|
| 功率Motor power | 5.5KW |
| 速度Speed | 80-110 pcs/min |
| 重量Weight | 1800KG |
| 外形尺寸Dimension | 1700*1700*1500mm |

J型成型机J type forming machine

| | |
|---------------|------------------|
| 功率Motor power | 5.5KW |
| 速度Speed | 80-130 pcs/min |
| 重量Weight | 1500KG |
| 外形尺寸Dimension | 1700*1700*1500mm |

Office Staple Pin Forming And Packing Machine

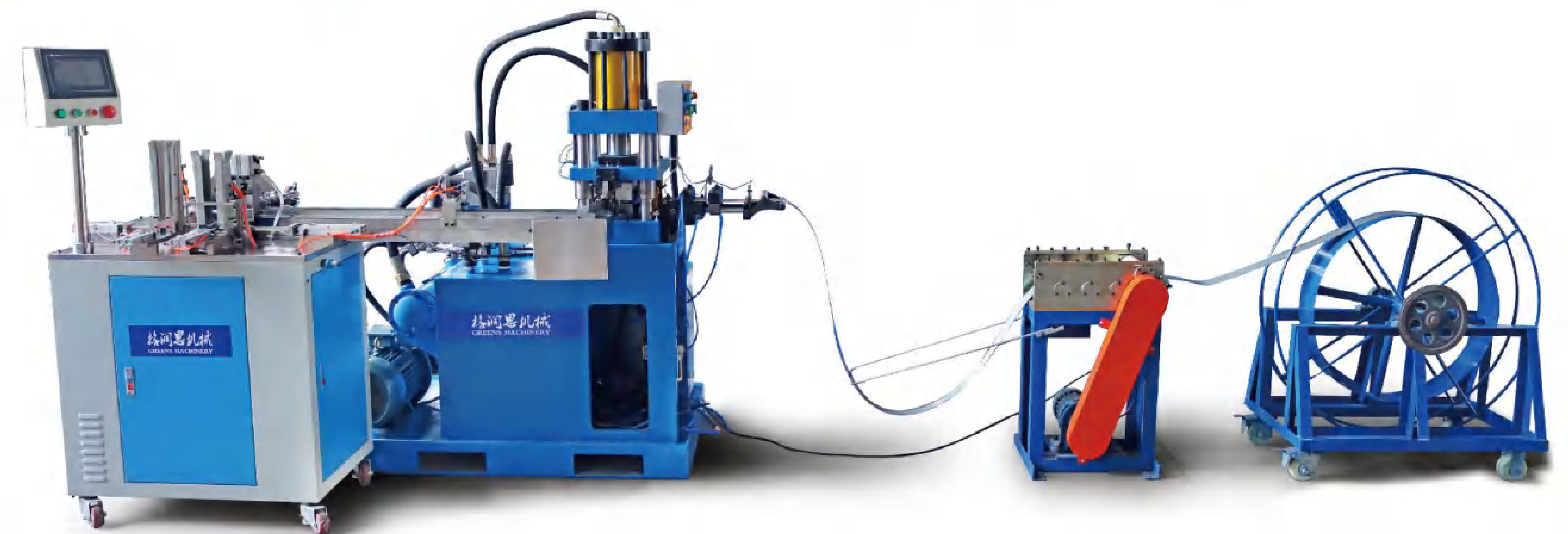
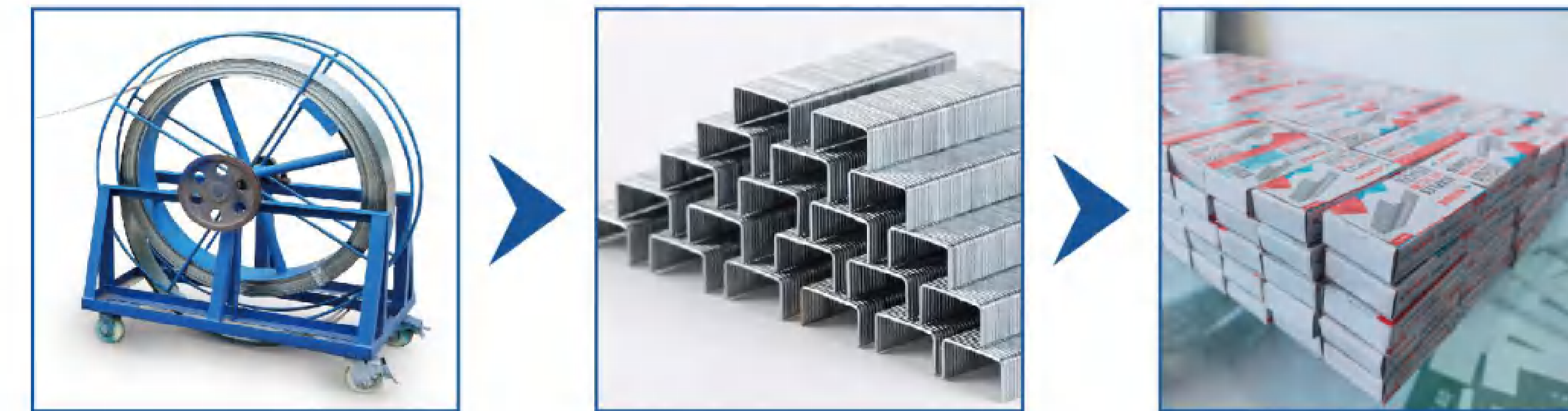

功能描述Function:

该机适用于生产24/6、26/6、10号订书钉，摒弃了传统的重型冲床，采用液压系统作为执行部分，采用PLC微电脑集中控制。具有运行安全、性能稳定、噪音低等特点。

This machine Suitable for producing 24/6, 26/6, No.10 staple pins, abandons traditional heavy-duty punches, uses hydraulic system as the execution part, and uses PLC microcomputer centralized control. It has the characteristics of safe operation, stable performance and low noise.

| | |
|-----------------------|-------------------|
| 功率 Motor power | 5.5 KW |
| 产量 Capacity | 12-18 pieces/min |
| 包装速度 Packing speed | 4-7 box/min |
| 重量 Weight | 1400 KG |
| 外形尺寸 Dimension | 1345*1170*1700 mm |



ALEMİNSAN MAKİNE
www.aleminsan.com.tr

Yafes ALEMİN
CEO

T: +90 216 394 31 32
G: +90 532 795 55 89
F: +90 216 394 34 28
Mesit Mah. İlim Sk. No: 1 Orhanlı
Tuzla / İstanbul / Türkiye

ALEMİN SAN
SOĞUK TEL ÇEKME

ALEMİN SAN
KANEPE VE KOLTUK MEKANİZMA SİSTEMLERİ

ALEMİN SAN
SOĞUK ÇEKME LAMA

YETKİLİ SATIŞ EKİBİMİZ BÜLENT ALEMİN YAFES ALEMİN MERT ALEMİN DOĞUKAN ALEMİN



产品类型: 干壁钉 (磷化干壁螺钉/蓝白锌干壁螺钉)
材质: 钢材
产品规格: M3.5*16, M3.5*20, M3.5*25, M3.5*30, M3.5*35, M3.5*40, M3.5*50
长度: 35, 40, 50, 20, 30, 25, 16 (mm)
产品工艺: 标准十字槽
特点: 硬度高, 不生锈
产品用途: 主要运用各种石膏板、轻质隔墙和天花板吊顶系列的安装。

Product Type: Dry wall nail (Phosphating dry wall screws/blue and white zinc dry wall screws)
Material: steel
Product Specifications: M3.5*16, M3.5*20, M3.5*25, M3.5*30, M3.5*35, M3.5*40, M3.5*50
Length: 35, 40, 50, 20, 30, 25, 16 (mm).....
Product technology: standard cross
Features: High hardness, no rust
Product usage: mainly use all kinds of plasterboard, light partition wall and ceiling ceiling series installation.



产品类型: 家具螺丝钉
材质: 不锈钢
产品规格: 各种规格
长度: 实际定制
特点: 硬度高, 不易生锈、耐腐蚀。
产品用途: 机械工业用紧固件, 汽车零部件、电力产业、太阳能产业、船用紧固件、桥梁工程、家具、电子、电器行业用紧固件, 建筑装修用紧固件, 铁路行业等。

Product type: Furniture screws
Material: stainless steel
Product specifications: various specifications
Length: actual customization
Features: high hardness, not easy to rust, corrosion resistance.
Application: Fasteners for machinery industry, auto parts, electric power industry, solar energy industry, Marine fasteners, bridge engineering, furniture, electronics, electrical appliances industry, construction and decoration fasteners, railway industry, etc.



产品类型: 钻尾螺丝钉
材质: 钢
产品规格: 各种规格
长度: 实际定制
槽型: 外六角
作用方式: 钻尾
特点: 较高硬度和韧性, 耐腐蚀性较好, 热强性和冷变型性能减速震性很好。
产品用途: 适用各种钢板、槽钢、彩钢瓦等。

Product type: Drill end screw
Material quality: steel
Product specifications: various specifications
Length: actual customization
Bad type: outer hexagon
Mode of action: drill tail
Features: high hardness and toughness, good corrosion resistance, thermal strength and cold deformation performance deceleration shock is very good.
Application: suitable for all kinds of steel plate, channel steel, color steel tile, etc.



产品类型: 自攻螺丝钉
材质: 碳钢和不锈钢两种。
产品规格: 各种规格
长度: 实际定制
产品工艺: 标准十字槽
特点: 硬度高, 芯部韧性好。
产品用途: 用于薄的金属板(钢板、锯板等)之间的连接。

Product type: self tapping screw
Material: carbon steel and stainless steel.
Product specifications: various specifications
Length: actual customization
Product technology: standard cross
Features: high hardness, good toughness of the core.
Application: Used for connecting thin metal plate (steel plate, saw plate, etc.).



电脑维修及组装
Computer repair and assembly



门窗维修
Doors and Windows maintenance



吊顶、家用装修
Ceiling, home decoration



家用电器安装维修
Installation and maintenance of household appliances



组装车间
Assembly workshop



桥梁修建紧固
Bridge construction fastening



家具紧固
Furniture fastening



家具紧固
Furniture fastening



ALEMINSAN MAKİNE
www.aleminsan.com.tr

Yafes ALEMİN
CEO

T: +90 216 394 31 32
G: +90 532 795 55 89
F: +90 216 394 34 28
Mesic Mah. İlim Sk. No: 1 Orhanlı
Tuzla / İstanbul / Türkiye

ALEMİN SAN
SOĞUK TEL ÇEKME

ALEMİN SAN
KANEPE VE KOLTUK MEKANİZMA SİSTEMLERİ

ALEMİN SAN
SOĞUK ÇEKME LAMA

YETKİLİ SATIŞ EKİBİMİZ BÜLENT ALEMİN YAFES ALEMİN MERT ALEMİN DOĞUKAN ALEMİN





YETKİLİ SATIŞ EKİBİMİZ BÜLENT ALEMİN YAFES ALEMİN MERT ALEMİN DOĞUKAN ALEMİN

钻尾螺丝切尾机 Drilling Tail Screw Cut Machine

功能描述 Function:

该一模二冲高速冷镦机是专业用于生产一般普通各类螺丝产品，此机速度快、精度高大大提高生产效率。
This high speed heading machine is specialized in manufacturing common types screws.



| | | | | | |
|---------------------------|--------------|--------------|--------------|--------------|--------------|
| 型号 Model | HM-1030 | HM-1563 | HM-20102 | HM-20120 | HM-1576 |
| 最大可制外径 Max Diameter | Φ2-4mm | Φ3-5mm | Φ3-6mm | Φ3-6mm | Φ3-6mm |
| 最大可制长度 Max Length rang | 5-30 | 5-63 | 5-102 | 5-120 | 5-76 |
| 每分钟产量 Capacity | 180-220 | 150-170 | 70-90 | 60-80 | 150-170 |
| 电机功率 Motor | 1.5KW | 2.2KW | 5.5KW | 5.5KW | 3KW |
| 油泵功率 Oil Pump | 1/4KW | 1/4KW | 1/4KW | 1/4KW | 1/4KW |
| 净重 Net Weight | 1200KG | 1700KG | 3000KG | 3500KG | 1700KG |
| 外形尺寸 Dimensions | 1.7*1.7*1.5m | 2.1*1.9*1.5m | 2.8*2.1*1.5m | 2.5*1.2*1.5m | 2.2*1.9*1.5m |



| | |
|----------------------------------|------------------------------------|
| 主马达 Main Motor | 5.5KW 6P 3PH (7.5HP) |
| 电压 Voltage | Depends on the customer |
| 变频器 Inverter | 7.5KW (10HP) |
| 生产速度 (单打) Producing Speed | 120-520pcs/min (Single Stroke) |
| 生产速度 (双打) Producing Speed | 60-150pcs/min (Double Stroke) |
| 生产规格 Wire Diameter | #6 (Φ2.8) - #12 (Φ4.3) No.1-No.3 |
| 震动送料机 Vibrator Feeder | Φ620mm+silnet PU gelatin spraying |
| 生产长度 Screw Length | 9.5mm-125mm (3/8" -5") |
| 模具规格 Die Holder | MB or MA (Depends on the customer) |
| 自动控制系统 Auto-Action Controller | PLC Controller |
| 机械重量 Machine WT | approx. 1994KG 2S+2KG |
| 外形尺寸 Dimensions | 1900mm×1400mm×1600mm |

高速搓丝机 High Speed Thread Rolling Machine

功能描述 Function:

本设备是将螺丝及五金产品进行有序的排列下料搓丝，加工各种普通螺丝。
This machine is to make thread of screws and hardware products, which is to produce different types of common screws.



| | | | | |
|------------------------|-----------------|---------------|---------------|----------------|
| 型号 Model | CH4R | CH5R | CH6R | CH8R |
| 搓牙直径 Thread Dia | 2-4mm | 4-6mm | 4-8mm | 4-8mm |
| 搓丝长度 Thread Length | 35 | 5-50 | 6-60 | 8-120 |
| 每分钟产量 Capacity | 25-380 | 200-240 | 180-220 | 180-210 |
| 模具尺寸 Die Dimensions | 76*89*40 | 90/105*25*60 | 100/115*25*80 | 108/127*25*120 |
| 主电机 Main Motor | 2.2-6KW | 4.0-4KW | 5.5-4KW | 7.5-4 |
| 油泵功率 Oil Pump | 0.37KW | 0.37KW | 0.37KW | 0.37KW |
| 净重 Net Weight | 1040KG | 1000KG | 2100KG | 2300KG |
| 装箱体积 Dimension | 1.56*1.18*1.79m | 1.35*1.7*1.5m | 2.5*1.2*1.6m | 2.7*1.4*1.7m |

插片机 Insert machine

功能描述 Function:

- 1.利用油星方式，使螺丝与华司做快速组合。
- 2.利用旋转上升的方式，提高生产速度。
- 3.使用PLC控制做高速运转，精确检测出不良品（螺丝与华司未结合完成）。
- 4.操作箱面板，有异常检测LED显示，方便操作者做故障排除。



1. Bring the screws and washers into plate movement of both within the machine; it makes the assembly of screws with washers faster.
2. Use revolving and rising methods to enhance the production speed.
3. Use the PLC control to precisely examine irregular products (screws and washers combination has not completed).
4. The operating box has LED demonstration when a problem occurs, it is more convenient for the operator to trouble shoot.

| | |
|---|----------------|
| 生产速度 (单打) Production speed (singles) | 120-520pcs/min |
| 生产速度 (双打) Production speed (doubles) | 60-150pcs/min |
| 生产长度 Production length | 9.5-125mm |
| 磨具规格 Abrasive specifications | MB or MA |
| 自动控制系统 Automatic control system | PLC Controller |
| 机械重量 Machine weight | 2000kg |
| 外形尺寸 Dimensions | 1.8m*1.4m*1.6m |



ALEMİNSAN MAKİNE
www.aleminsan.com.tr

Yafes ALEMİN
CEO

T: +90 216 394 31 32
G: +90 532 795 55 89
F: +90 216 394 34 28
Mescit Mah. İlim Sk. No: 1 Orhanlı
Tuzla / İstanbul / Türkiye



YETKİLİ SATIŞ EKİBİMİZ BÜLENT ALEMİN YAFES ALEMİN MERT ALEMİN DOĞUKAN ALEMİN

Widely used in aircraft, ships, automobiles, machinery, furniture, electrical appliances, solar energy, containers, luggage and other industries.



酸洗磷化卷材
Pickling and Phosphating Coil

冷镦机
Cold heading machine

搓牙机
Tooth rolling machine



滚镀锌机
Rolling-galvanizing machine

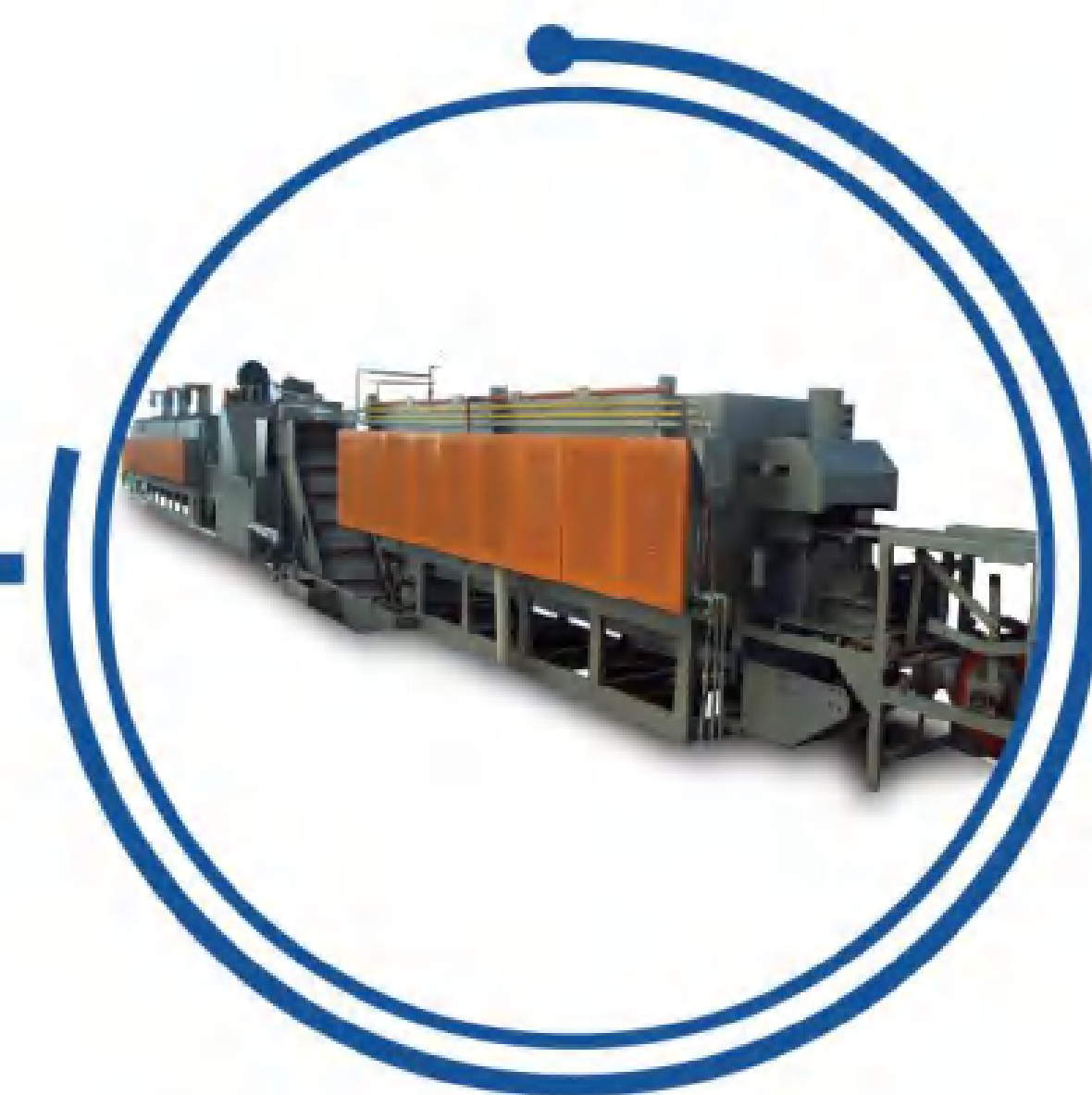

网带炉
Mesh belt furnace



成品
Finished product





ALEMİNSAN MAKİNE
www.aleminsan.com.tr

Yafes ALEMİN
CEO

T: +90 216 394 31 32
G: +90 532 795 55 89
F: +90 216 394 34 28
Mesit Mah. İlim Sk. No: 1 Orhanlı
Tuzla / İstanbul / Türkiye

ALEMİN SAN
SOĞUK TEL ÇEKME

ALEMİN SAN
KANEPE VE KOLTUK MEKANİZMA SİSTEMLERİ

ALEMİN SAN
SOĞUK ÇEKME LAMA

YETKİLİ SATIŞ EKİBİMİZ BÜLENT ALEMİN YAFES ALEMİN MERT ALEMİN DOĞUKAN ALEMİN

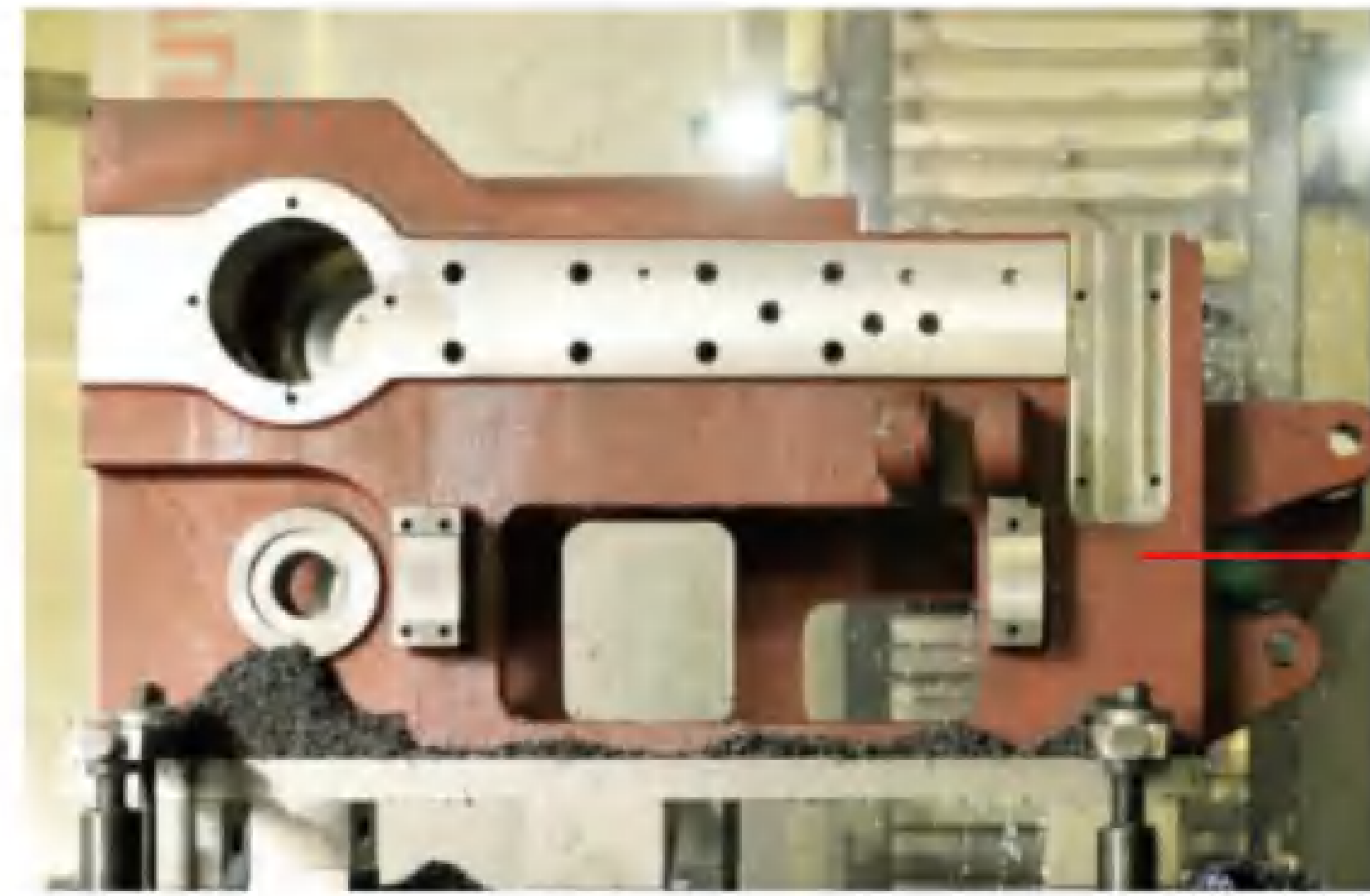

铸铁以抗拉强度极好的合金铸铁铸成，并经国家检验部门质量检测，具有极佳的吸震性能，在高速冲压及高速进给的情况下，机身沉稳，震动小，保证机台的长期精度。

Cast iron is made of alloy cast iron with excellent tensile strength, and has been inspected by the national inspection department. It has excellent shock absorption performance. In the case of high-speed stamping and high-speed feeding, the body is stable, and the vibration is small, which ensures the long-term accuracy of the machine.

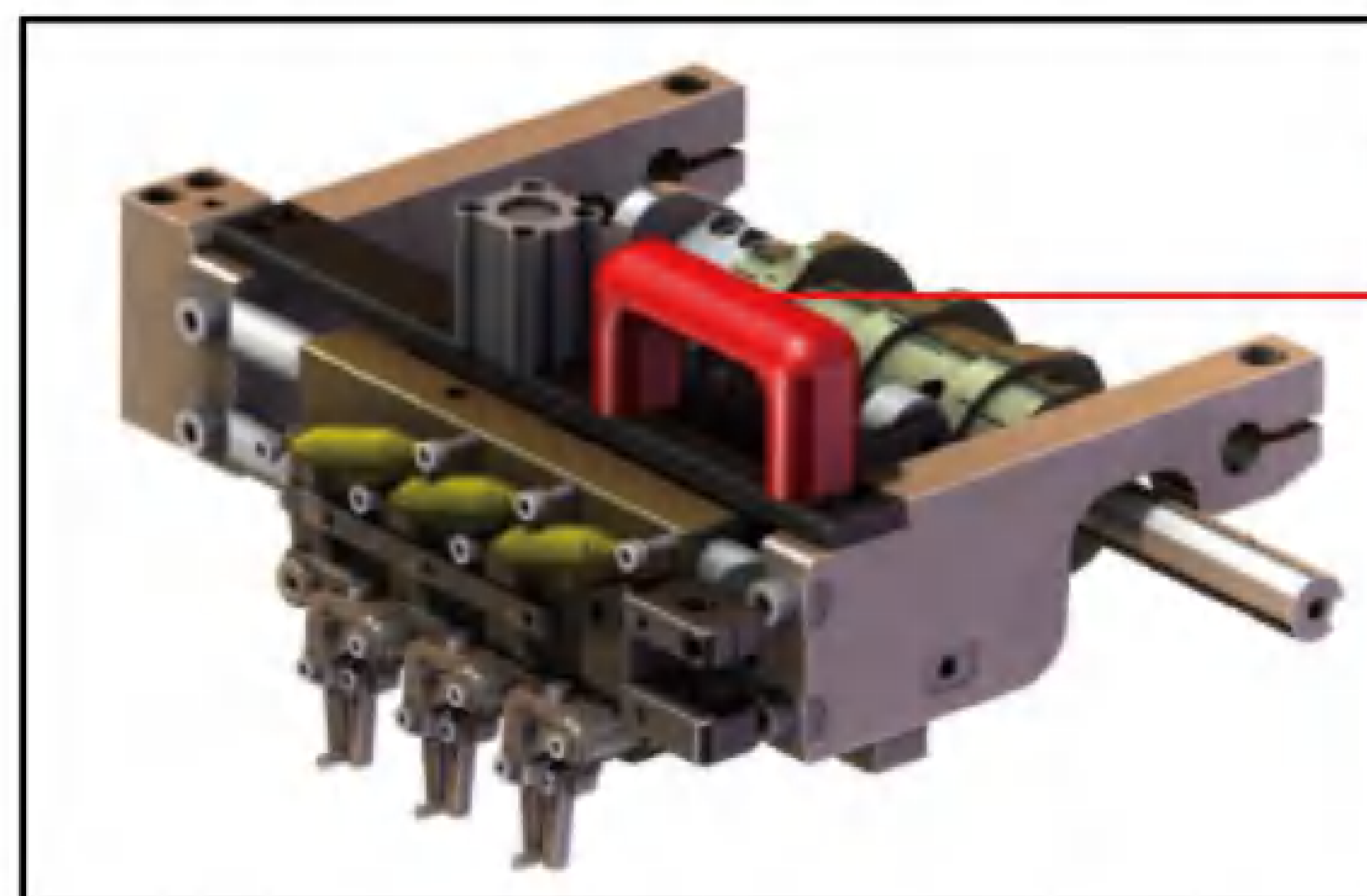

夹台：自主专利研发的模块化夹钳系统，高速精准，操作便利，易于维护。节省了操作的员调机时间，减少了新手学习时间

Clamp Sets: The modular clamp system developed by our own patent has the advantages of high speed and precision, convenient operation and easy maintenance. It can save the time for the operator to adjust the machine and reduce the learning time of the novice.



伺服电机特性：格润思高速精密多工位冷墩机新动力、新格局、新增长，创造更高生产效率与能源效益。

●主马达 采用伺服电机驱动控制，电路系统为伺服驱动器加PLC智能操作检测系统，(电压280V以上)对厂里电压与电网起到很好的保护，节能、降耗、省电，综合效益30%以上。

●正反寸动响应速度快，对模可以秒动，低高速输出转矩一样，扭力线性输出优越的控制产品精度，生产过程效率提高(无线变速)。

GREENS high speed precision multi position cold heading machine: new power, new pattern, new growth, creating higher production efficiency and energy efficiency.

●The main motor is driven and controlled by servo motor: the circuit system is servo driver and PLC intelligent operation detection system (voltage above 280v), which can protect the voltage and power grid of the plant, save energy, reduce consumption and save power more than 30%.

●The positive and negative inching response speed is fast, the mold can move in seconds, and the low and high speed output torque is the same. The torque linear output has superior control accuracy, and the production process efficiency is improved (stepless speed change).

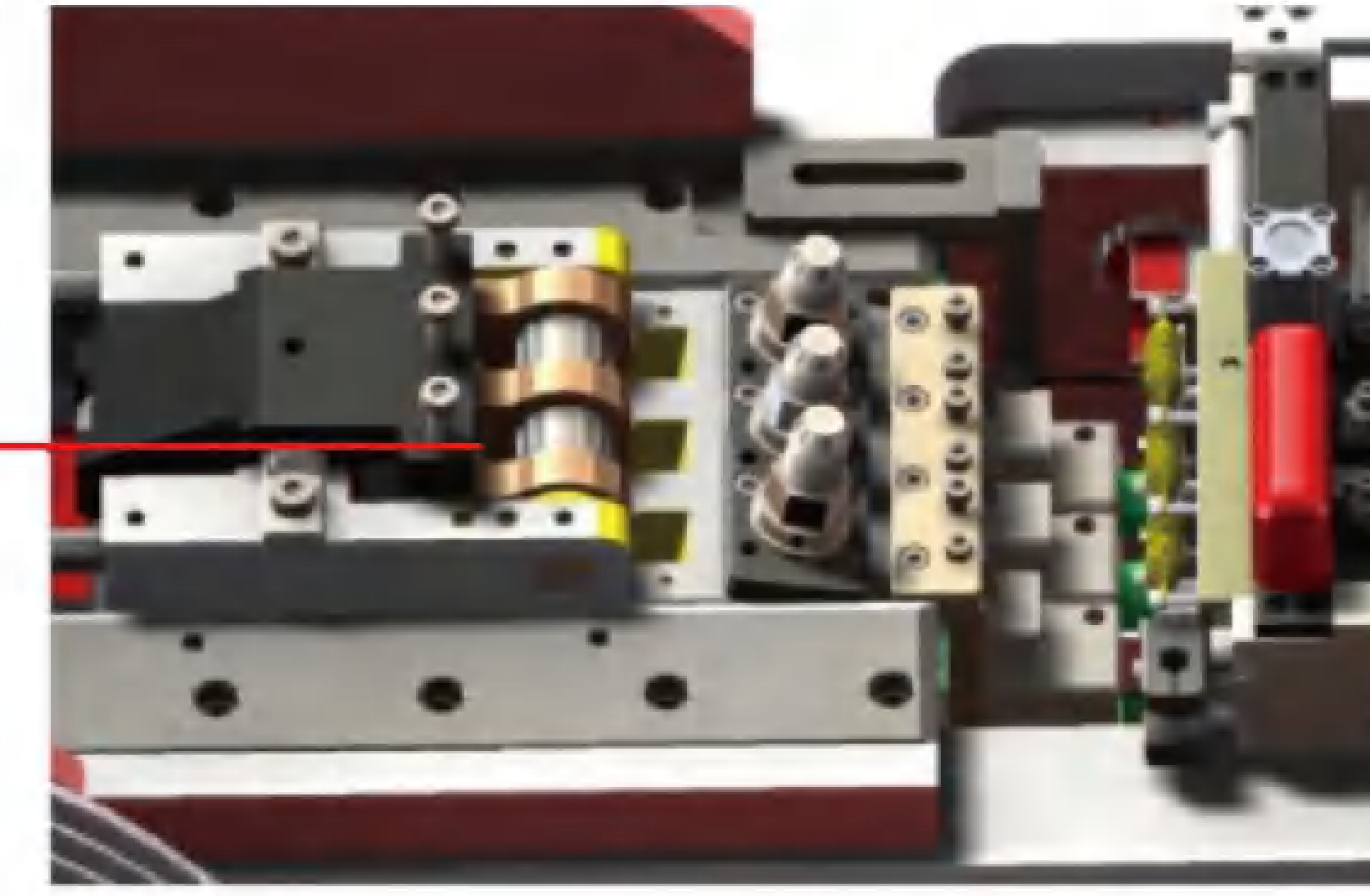
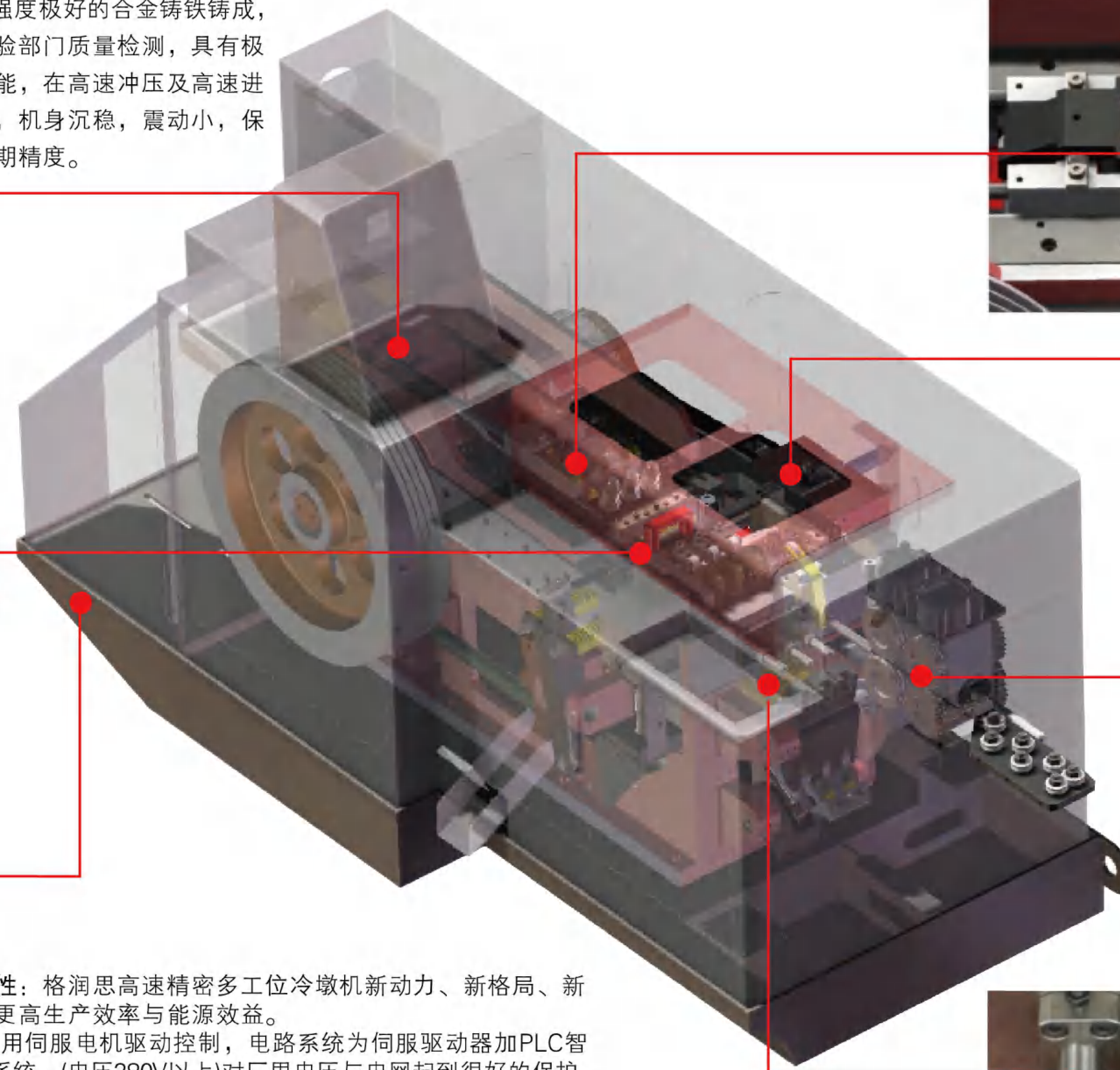

主滑台：加长一体式特殊铸件滑块，采用进口五轴加工一次加工成型，保证精度和长期耐磨。

Main Slide: Lengthening integral special casting slide block, using imported five axis processing, one-time processing to ensure accuracy and long-term wear resistance.



切料：自主专利研发的切料系统，可实现方便的切刀快速安装，优化的切料曲线，保证切料平整稳定。

Material Cut-off: The cutting system developed by our own patent can realize the quick installation of the cutter, optimize the cutting curve and ensure the smooth and stable cutting.

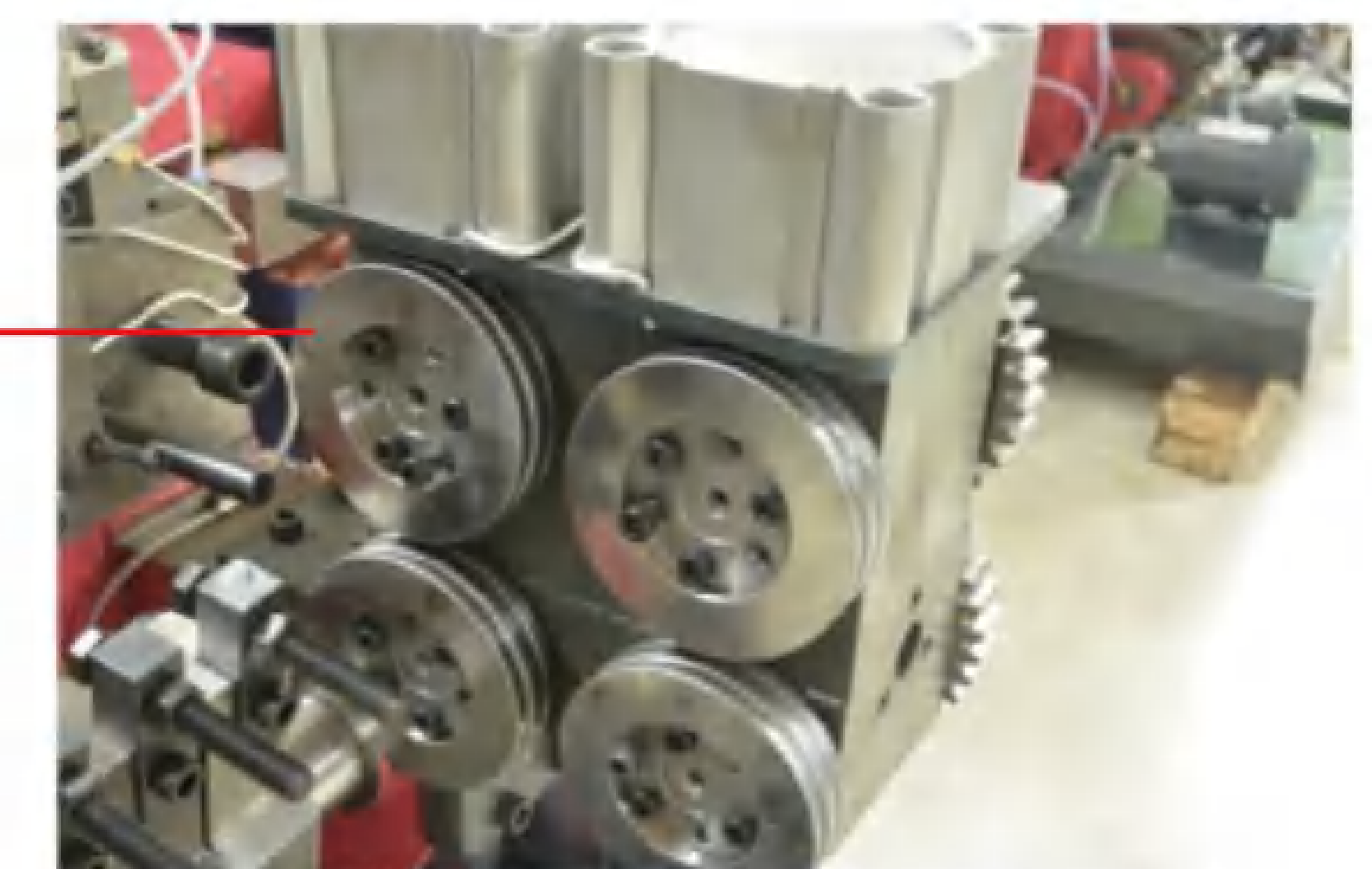

送料：采用气压可调压式双进料系统，高精度送料传动齿轮，保证送料长期精度和稳定。

Material Feeding: The double feeding system with adjustable air pressure and high-precision transmission gear ensures long-term accuracy and stability of feeding.

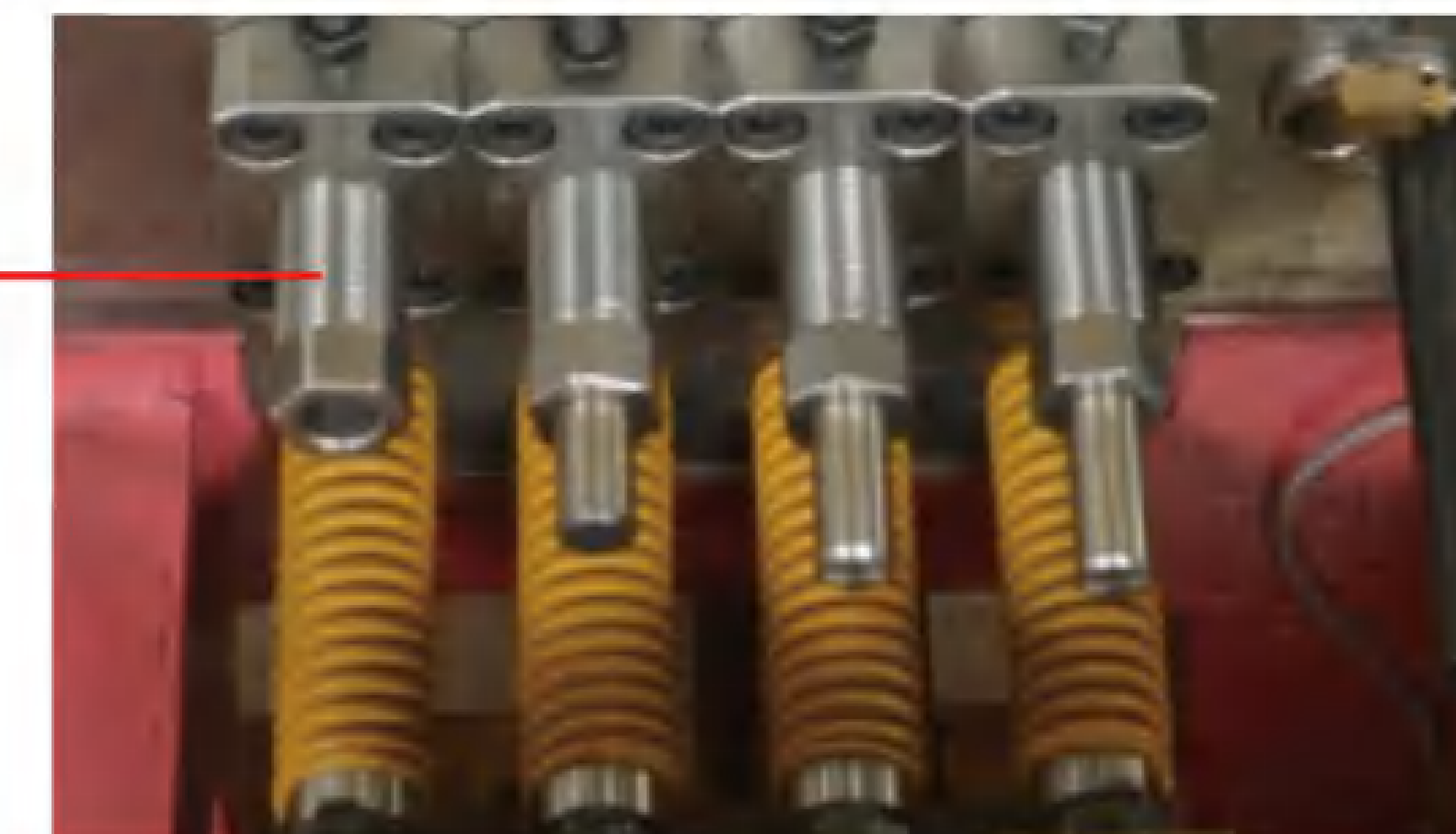

后通出：采用凸轮模块，可每工位单独调整行程，可实现稳定产品排出和切边等功能。

Back Pass-out: With cam module, the stroke can be adjusted individually for each station, and the functions of stable product launch and trimming can be realized.



ALEMİNSAN MAKİNE
www.aleminsan.com.tr

Yafes ALEMİN
CEO

T: +90 216 394 31 32
G: +90 532 795 55 89
F: +90 216 394 34 28
Mescit Mah. İlim Sk. No: 1 Orhanlı
Tuzla / İstanbul / Türkiye

ALEMİN SAN
SOĞUK TEL ÇEKME

ALEMİN SAN
KANEPE VE KOLTUK MEKANİZMA SİSTEMLERİ

ALEMİN SAN
SOĞUK ÇEKME LAMA

YETKİLİ SATIŞ EKİBİMİZ BÜLENT ALEMİN YAFES ALEMİN MERT ALEMİN DOĞUKAN ALEMİN

| 型号 Model | GRS-103L | GRS-133S | GRS-133L | GRS-163S | GRS-203L |
|---------------------------------------|-------------|-------------|-------------|-------------|-------------|
| 工位数 No. Forging station | 3 | 3 | 3 | 3 | 3 |
| 成型力 kgs Forging force | 80.000 | 120.000 | 120.000 | 200.000 | 350.000 |
| 最大切断直径 mm Max cut-off dia | Φ 12 | Φ 15 | Φ 15 | Φ 18 | Φ 22 |
| 最大切断长度 mm Max cut-off length | 195 | 145 | 250 | 200 | 240 |
| 生产速度 pcs/min Speed Range | 85-160 | 90-160 | 60-110 | 70-120 | 50-80 |
| 动模顶出行程 mm P.K.O Stroke | 15 | 30 | 30 | 40 | 50 |
| 定模顶出行程 mm K.O.Stroke | 165 | 115 | 230 | 170 | 220 |
| 主滑台行程 mm Main slide stroke | 280 | 200 | 350 | 260 | 346 |
| 主电机功率 kw Main motor | 22 | 30 | 30 | 55 | 75 |
| 剪模外形尺寸 mm Cut-off-die size | Φ 45*59L | Φ 63*69L | Φ 55*70L | Φ 60*90L | Φ 75*120L |
| 动模外形尺寸 mm Punch die size | Φ 53*112L | Φ 60*130L | Φ 60*179L | Φ 75*185L | Φ 90*215L |
| 定模外形尺寸 mm Main die size | Φ 75*200L | Φ 86*135L | Φ 86*265L | Φ 100*190L | Φ 125*240L |
| 模具间距 mm Die pitch | 90 | 98 | 110 | 120 | 140 |
| 机器外形尺寸 mm Machine dimension(L*W*H) | 570*250*230 | 460*260*200 | 780*260*270 | 650*290*250 | 760*300*300 |
| 机器重量 Ton Machine weight (Approx) | 19.5 | 19.5 | 31 | 36 | 55 |
| 可制螺丝直径 mm Normal bolt size | 6-10 | 8-13 | 8-13 | 10-18 | 12-22 |
| 可制螺丝头下长度mm Shank length of blank | 25-160 | 20-110 | 70-210 | 20-160 | 25-210 |

| 型号 Model | SJBF-164S | SJBF-164LL | SJBF-164UL | SJBF-204L | SJBF-204LL | SJBF-254SL | SJBF-254LL | SJBF-384L |
|---------------------------------------|-------------|-------------|--------------|-------------|-------------|-------------|-------------|--------------|
| 工位数 No. Forging station | 4 | 4 | 4 | 4 | 4 | 4 | 4 | 4 |
| 成型力 kgs Forging force | 220.000 | 220.000 | 230.000 | 380.000 | 380.000 | 450.000 | 450.000 | 800.000 |
| 最大切断直径 mm Max cut-off dia | Φ 18 | Φ 18 | Φ 23 | Φ 22 | Φ 22 | Φ 28 | Φ 28 | Φ 42 |
| 最大切断长度 mm Max cut-off length | 200 | 350 | 510 | 240 | 360 | 260 | 380 | 450 |
| 生产速度 pcs/min Speed Range | 70-110 | 40-70 | 35-50 | 50-90 | 40-65 | 40-80 | 35-60 | 30-50 |
| 动模顶出行程 mm P.K.O Stroke | 45 | 45 | 60 | 50 | 50 | 40 | 45 | 60 |
| 定模顶出行程 mm K.O.Stroke | 170 | 320 | 510 | 220 | 320 | 210 | 315 | 380 |
| 主滑台行程 mm Main slide stroke | 260 | 490 | 670 | 346 | 496 | 330 | 510 | 570 |
| 主电机功率 kw Main motor | 55 | 55 | 75 | 75 | 75 | 110 | 110 | 200 |
| 剪模外形尺寸 mm Cut-off-die size | Φ 60*90L | Φ 64*100L | Φ 74*120L | Φ 75*120L | Φ 75*120L | Φ 80*130L | Φ 99*150L | Φ 120*150L |
| 动模外形尺寸 mm Punch die size | Φ 75*185L | Φ 75*185L | Φ 75*250L | Φ 90*215L | Φ 90*215L | Φ 120*270L | Φ 120*270L | Φ 145*320L |
| 定模外形尺寸 mm Main die size | Φ 100*190L | Φ 100*345L | Φ 100*510L | Φ 125*240L | Φ 125*345L | Φ 140*250L | Φ 148*345L | Φ 190*450L |
| 模具间距 mm Die pitch | 120 | 120 | 120 | 140 | 140 | 160 | 160 | 216 |
| 机器外形尺寸 mm Machine dimension(L*W*H) | 650*310*260 | 870*320*300 | 1000*320*300 | 760*320*300 | 870*320*320 | 830*430*330 | 980*420*350 | 1100*520*400 |
| 机器重量 Ton Machine weight (Approx) | 43 | 60 | 80 | 62 | 76 | 105 | 125 | 260 |
| 可制螺丝直径 mm Normal bolt size | 10-16 | 10-16 | 12-20 | 12-20 | 12-20 | 14-27 | 14-27 | 20-40 |
| 可制螺丝头下长度mm Shank length of blank | 20-160 | 70-310 | 150-490 | 25-210 | 70-310 | 35-210 | 70-310 | 70-370 |



ALEMİNSAN MAKİNE
www.aleminsan.com.tr

Yafes ALEMİN
CEO

T: +90 216 394 31 32
G: +90 532 795 55 89
F: +90 216 394 34 28
Mesit Mah. İlim Sk. No: 1 Orhanlı
Tuzla / İstanbul / Türkiye

ALEMİN SAN
SOĞUK TEL ÇEKME

ALEMİN SAN
KANEPE VE KOLTUK MEKANİZMA SİSTEMLERİ

ALEMİN SAN
SOĞUK ÇEKME LAMA

YETKİLİ SATIŞ EKİBİMİZ BÜLENT ALEMİN YAFES ALEMİN MERT ALEMİN DOĞUKAN ALEMİN

螺母冷镦机
Nut cold heading machine



| | |
|------------------|---------------|
| 模数 | 6 |
| 最大切断直径 (MAX) mm | 24 |
| 最大切断长度 (MAX) mm | 60 |
| 后托定出长度mm | 130 |
| 母模中心距离mm | 100 |
| 造压力(TON) | 270 |
| 每分钟最大产能(PCS/MIN) | 90 |
| 主马达(4/8POLE)kw | 60 |
| 油泵马达kw | 1.5 |
| 油用量 (GALLON) | 380 |
| 机械重量 (TON) | 25 |
| 机械尺寸 (L*W*H) m | 5.3*2.56*1.95 |

螺母攻丝机
Nut Thread Rolling Machine



| 机型 Mode | 转/分钟 Revolution per minute | 只数/分钟 Number/ min | 功率 Power |
|--|----------------------------------|-------------------------|---------------------------|
| 气压双轴攻牙机 (M3-M5) Pneumatic double tapping machine (M3-M5) | 2000 | 90-80 | 0.55/2/2 |
| | 1800 | 80-75 | 0.75/4/2 |
| | 1700 | 75-70 | |
| 气压双轴攻牙机 (M6-M8) Pneumatic double tapping machine (M6-M8) | 1400 | 60-55 | 1.1/4/2 |
| | 1200 | 50-45 | |
| 气压双轴攻牙机 (M22-M24) Pneumatic double tapping machine (M22-M24) | 300 | 10-8 | 3/8/2带链条 |
| | 280 | 9-7 | |
| 气压双轴攻牙机 (M27-M33) Pneumatic double tapping machine (M27-M33) | 255 | 8-6.5 | 4/4/2变频器, 变频电机, 减速器 |
| | 240 | 7.5-6 | |
| | 225 | | |
| 气压双轴攻牙机 (M36-M42) Pneumatic double tapping machine (M36-M42) | 210 | 6.5-5.5 | 4/4/2变频器, 变频电机, 减速器 |
| | 180 | 5.5-4.5 | |
| | 195 | | |
| 气压双轴攻牙机 (M45-M48) Pneumatic double tapping machine (M45-M48) | 165 | 4.5-4 | 5/6/2变频器, 变频电机, 减速器 |
| | 150 | 4-3.5 | |

Mesh belt furnace

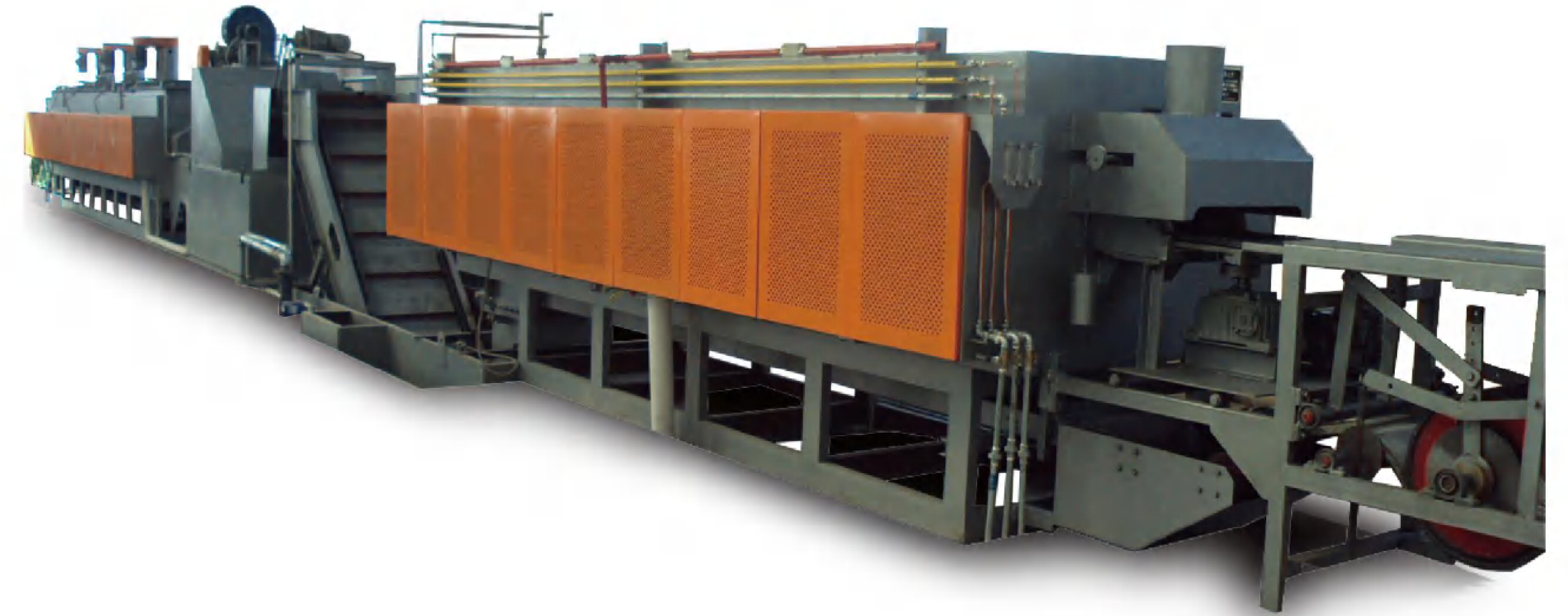

| 型号规格 Model | Rcm-200-9 | Rcm-45-9 |
|----------------------------------|-------------------|----------|
| 功率 Motor power | 200 | 45 |
| 装载量 Capacity (KG/hour) | 200-250 | 60 |
| 工作尺寸 Working size (mm) | 2100*400 | 2100*220 |
| 净重 Net Weight (kg) | 18000 | 10000 |
| 工作温度 Working temperature (°C) | Quenching furnace | 820~850 |
| | Quenching tank | 40~80 |
| | Cleaning machine | 20~80 |
| | Annealing stove | ≤600 |



ALEMINSAN MAKİNE
www.aleminsan.com.tr

Yafes ALEMİN
CEO

T: +90 216 394 31 32
G: +90 532 795 55 89
F: +90 216 394 34 28
Mesci Mah. İlim Sk. No: 1 Orhanlı
Tuzla / İstanbul / Türkiye



YETKİLİ SATIŞ EKİBİMİZ BÜLENT ALEMİN YAFES ALEMİN MERT ALEMİN DOĞUKAN ALEMİN

Point slotting machine



| | | | | |
|----------------------------------|-----------|-----|------------|-----|
| 型号规格 Model | RG-30-9 | | RG-45-9 | |
| | RG-60-9 | | RG-120-9 | |
| 功率 Power (kw) | 30 | 45 | 60 | 120 |
| 装载量 Capacity (kg) | 60 | 100 | 120 | 200 |
| 工作尺寸 Working size (mm) | φ 300×620 | | φ 520×680 | |
| | φ 600×750 | | φ 750×1000 | |
| 加热功率 Heat power (kw) | 30 | 45 | 60 | 120 |
| 工作温度 Working temperature (°C) | 950 | | | |

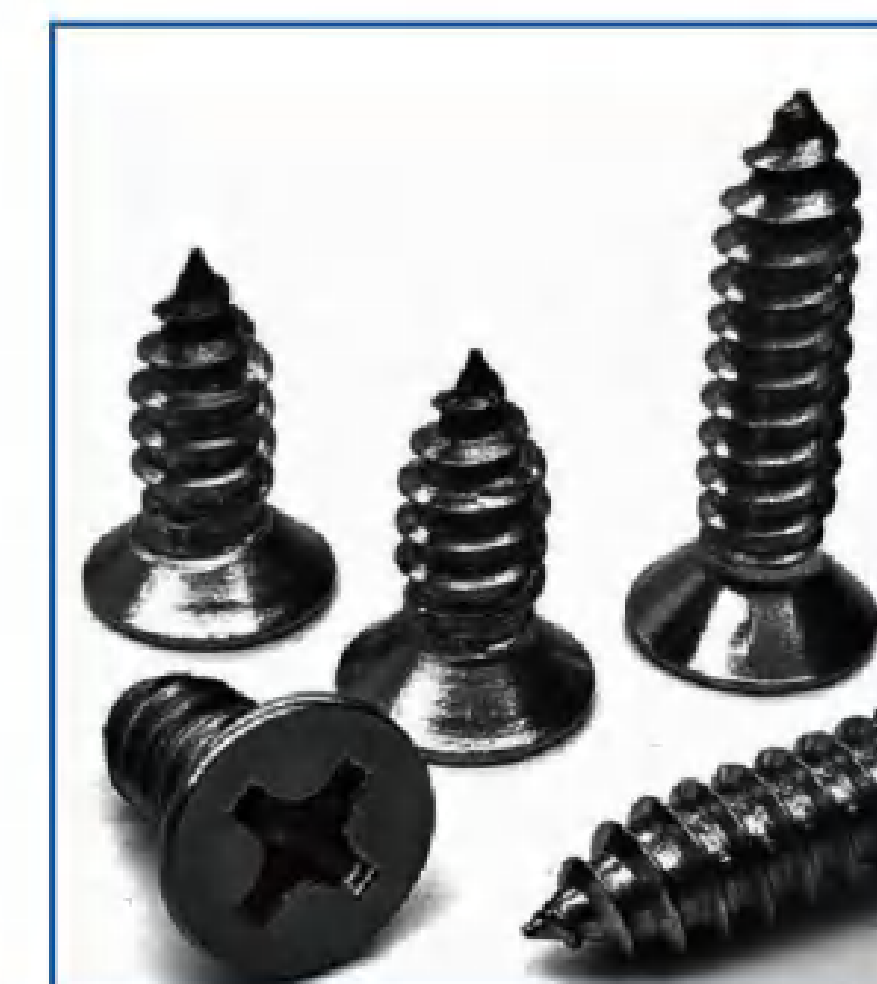
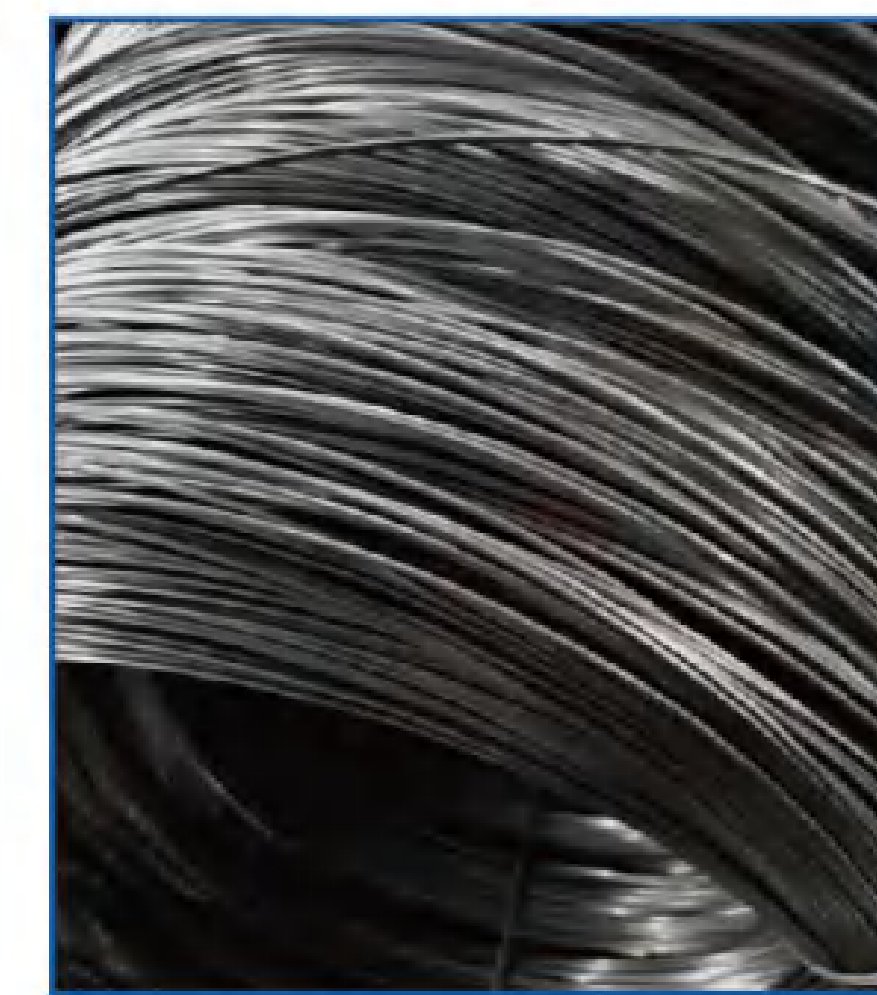

井式电阻退火炉

Well type resistance annealing furnace

功能描述 Function:

井式电阻炉系周期作业式电炉，供钢铁零件淬火、回火、退火用，特别适用于铁丝再结晶退火，节能型电炉优点为炉衬采用刺纤维毯预制件组成，吸热系数小，电热元件悬挂在炉膛内，充分裸露直接辐射，热效率高，比传统电炉节能30%以上。

This kind of furnace work periodically, and it is suitable for quenching, tempering, annealing of the steel parts, especially used for iron wire recrystallization annealing. The advantages of an energy-saving resistance furnace lie in that the furnace lining is made of tufted fiber blanket, so it is of small heat absorption. And the thermoelectric components are hung in the hearth, which is fully exposed and directly irradiated, therefore its heat efficiency is high, and can save more than 30% of the energy than the traditional furnace.



| | |
|-------------------------------------|--------|
| 额定功率 Rated power (kw) | 18-480 |
| 最高工作温度 Max working temperature (°C) | 900 |
| 最大直径 Max Diameter (mm) | 3500 |

| | |
|------------------------------|----------------------------------|
| 切刀电机 Cutter motor | 0.37KW,6P,3PH(1/2HP) |
| 分割减速电机 Split reducer motor | 0.37KW,4P,3PH(1/2HP 1:3) |
| 变频器 Inverter | Cutter motor 0.75kw(1HP) |
| 变频器 Inverter | Split 0.75kw (1HP) |
| 切削液电机 Cutting fluid motor | 0.1kw,3PH(1/8HP) |
| 自动控制系统 Auto-Action cotroller | PLC Controller |
| 震动送料机 Vibrator feeder | φ 750+silent PU gelatin spraying |
| 电压 Voltage | Assignde by client |
| 自攻钉 Self-Tapping screw | ST3.5-ST6.3(TYPE:17&25) |
| 机器螺丝 Machine screw | M3-M6(TYPE:23) |
| 螺丝长度 Screw length | 15m/m-150m/m |
| 生产速度 Production speed | approx.50-325pcs/min |
| 机器重量 Machine weight | approx.960kg |



ALEMINSAN MAKİNE
www.aleminsan.com.tr

Yafes ALEMİN
CEO

T: +90 216 394 31 32
G: +90 532 795 55 89
F: +90 216 394 34 28
Mesat Mah. İlim Sk. No: 1 Orhanlı
Tuzla / İstanbul / Türkiye



YETKİLİ SATIŞ EKİBİMİZ BÜLENT ALEMİN YAFES ALEMİN MERT ALEMİN DOĞUKAN ALEMİN

普通刺绳网机一般是指CS-A型双股刺绳机，双股刺绳机由绕丝和收丝加捻二部分连接组成，并配套四只放丝盘，该机主要适用于生产各种多股刺绳网，其使用材料应符合稳，操作灵活可靠，是国内目前唯一生产刺绳网的设备。

Ordinary barbed wire machine generally refers to CS-A double-strand barbed wire machine. The double-strand barbed wire machine is composed of two parts: winding wire and wire winding and twisting, and is equipped with four wire feeding reels. This machine is mainly suitable for To produce various multi-strand barbed wire nets, the materials used should be stable and the operation is flexible and reliable. It is the only equipment for producing barbed wire nets in China.

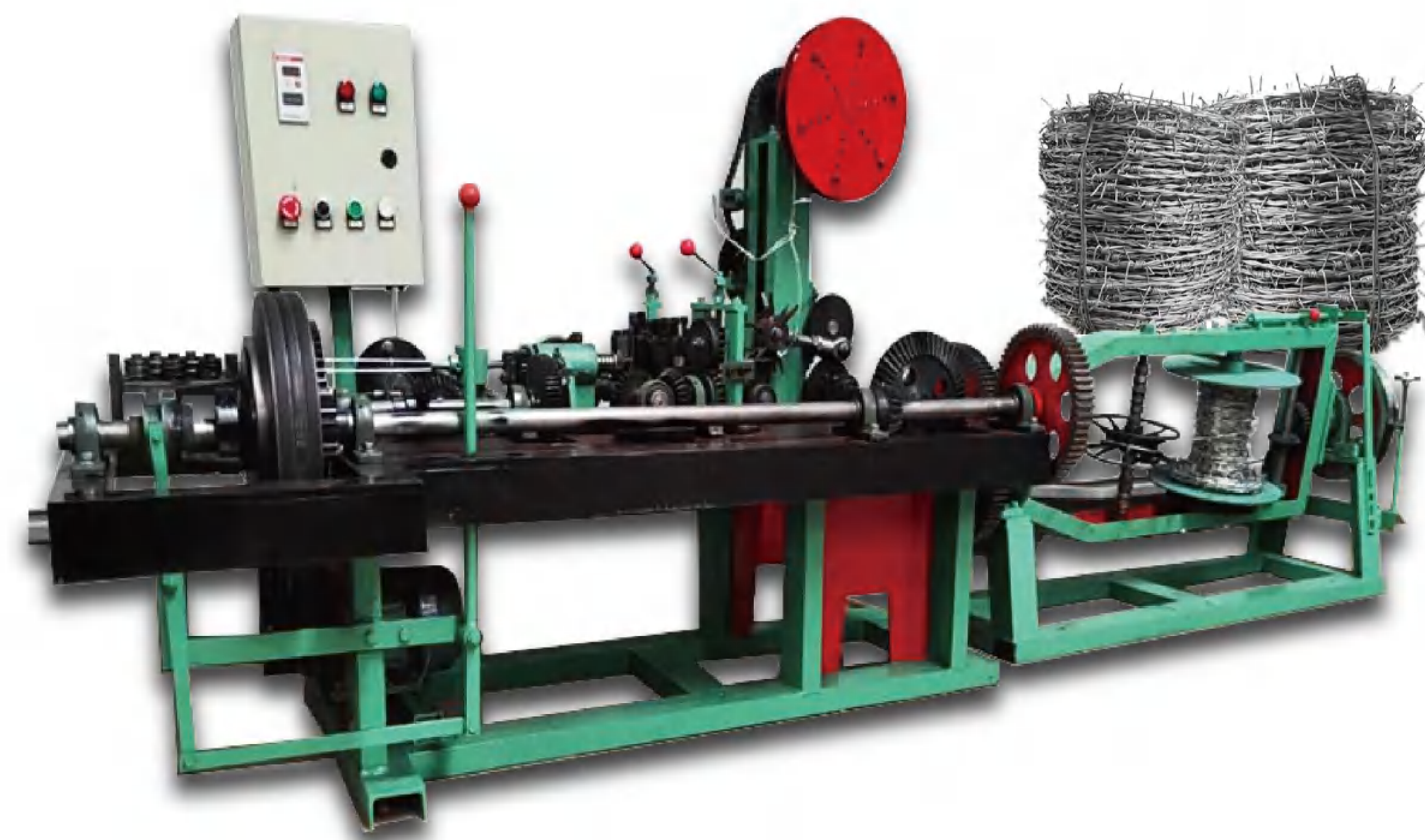

| | | | | |
|--|------------------------|-----------|-------------|------------|
| 主丝直径 Main wire diameter (mm) | 2.0-3.0 | | | |
| 刺丝直径 Barbed wire diameter (mm) | 1.8-2.4 | | | |
| 铁丝抗拉力 Wire Tensile Strength (N/mm ²) | 400-600 | | | |
| 刺间距 Thorn spacing (inch) | 3' (7.5cm) | 4' (10cm) | 5' (12.5cm) | 6' (15cm)3 |
| 电机功率 Motor power (kw) | 440 | | | |
| 电压 Voltage (V) | Main :2000*1200*1400 | | | |
| 外形尺寸 Dimensions (mm) | Auxiliary:2000*650*800 | | | |
| 重量 Weight (kg) | 1000 | | | |

LV-420B bag packing machine

本机振动储料斗通过振动的方式下料至磁力提升机，磁力提升机输送物料至称盒称重，称盒称重所需重量的约95%左右，剩下的通过振动盘计数补料的方式来达到客户总的需求量。

The vibrating storage hopper of this machine unloads the material to the magnetic hoist by vibration, and the magnetic hoist transports the material to the weighing box for weighing. way to meet the total demand of customers.



| | |
|---------------------------|--|
| 机型 Model | LV-420B装袋包装机 LV-420B bag packing machine |
| 电源规格 Power Specifications | 单相电 220V Single-phase electricity 220V |
| 包装材料 Packaging Materials | 复合膜(PET/PE, OPP/CPP) Composite film (PET/PE, OPP/CPP) |
| 制袋尺寸 Bag size | 最小 50mm(W)*50mm(L)/最大 200mm(W)*300mm(L) Min 50mm(W)*50mm(L)/Max 200mm(W)*300mm(L) |
| 计量范围 Measurement range | 1个-5kg,且在最大制袋范围内 1-5kg, and within the maximum bag making range |
| 计量方式 Measurement method | 称重+计数 Weighing + counting |
| 适用产品 Applicable Products | 螺丝, 螺母, 垫片, 铁钉等铁质五金(根据客户不同物料及规格来确定振动盘的数量) Screws, nuts, washers, iron nails and other iron hardware (according to the customer's different materials and specifications to determine the number of vibrating discs) |
| 选配 Optional | 打印机(可打印即时的时间, 字母, 数字, 二维码, 条形码, 简单的logo等) printer(Can print instant time, letters, numbers, QR codes, barcodes, simple logos, etc.) |



ALEMİNSAN MAKİNE
www.aleminsan.com.tr

Yafes ALEMİN
CEO

T: +90 216 394 31 32
G: +90 532 795 55 89
F: +90 216 394 34 28
Mesat Mah. İlim Sk. No: 1 Orhanlı
Tuzla / İstanbul / Türkiye



YETKİLİ SATIŞ EKİBİMİZ BÜLENT ALEMİN YAFES ALEMİN MERT ALEMİN DOĞUKAN ALEMİN

应用范围 Range of application ●●●●●



产品类型: 圆钉
材质: 低碳钢Q195
产品规格: 20/25/30/40/50/60/70/80/100/130/150 (mm)
特点: 采用优质的钢材制作, 具有很好的耐腐蚀性, 由于它的表面镀了锌, 大大的增加了它的使用寿命。
产品用途: 适用于软硬木材、普通塑料、修制家具、土墙翻砂以及家庭装饰中壁画悬挂等。

Product type: Round nails
Material: Low carbon steel Q195
Product specifications: 20/25/30/40/50/60/70/80/100/130/150 (mm)
Point: made of high quality steel, with good corrosion resistance, due to its surface plated with zinc, greatly increased its service life.
Application: suitable for soft and hard wood, ordinary plastics, furniture repair, earth wall sand foundry and fresco hanging in home decoration, etc.

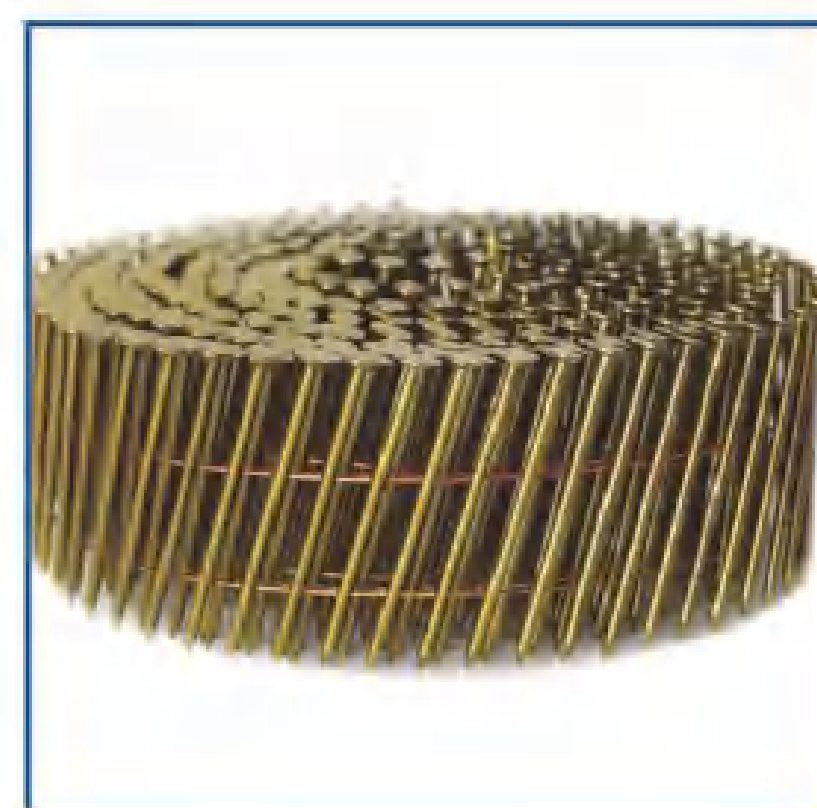

产品类型: 卷钉
材质: Q195/235
产品规格: 21X25(14000根), 21X28(14000根), 21X32(14000根)
特点: 具有高硬度, 抗拉强度高、耐腐蚀性强等特点。
产品用途: 卷钉广泛应用于木箱包装重负荷包装、木托盘、木制家具、木结构房屋高强度地板板等。

Product type: Coil nails
Material: Q195/235
Product specifications: 21X25(14000)pcs, 21X28(14000)pcs, 21X32(14000)pcs
Point: High hardness, high tensile strength, strong corrosion resistance and so on.
Application: Coil nails are widely used in heavy load packing of wooden cases, wooden pallets, wooden furniture, wooden structure building high strength floor board, etc.



产品类型: 螺纹钉
材质: Q195
产品规格: 1.5寸 2寸 2.5寸 3寸 3.5寸 4寸
长度: 3~300 (mm)
特点: 入木锋利、不易弯曲、钉帽圆整有强度等优点。
产品用途: 用于建筑、装饰、装潢、装修业等固定物体

Product type: Threaded nails
Material: stainless steel
Product specification: 1.5 inch 2 inch 2.5 inch 3 inch 3.5 inch 4 inch
Length: 3~300 (mm)
Point: the wood is sharp, not easy to bend, the nail cap round strength and other advantages.
Application: used for building, decoration, decoration, decoration industry and other fixed objects.



产品类型: 水泥钉 (钢钉)
材质: 45号钢或60号钢
特点: 硬度很大, 粗而短, 穿凿能力很强。
产品用途: 适用于装饰, 装潢业, 硬质木材, 轻质木龙骨的连接。广泛用于民用和军工建筑的水电安装和装修。

Product type: Cement nails (ST nails)
Material: 45 steel or 60 steel
Point: Hardness is very big, thick and short, piercing ability is very strong.
Application: Suitable for decoration, upholstery, hard wood, light wood keel connection. It is widely used in the installation and decoration of civil and military buildings.



产品类型: 镀锌钉
材质: 碳钢Q195/235
特点: 抗腐蚀能力强, 坚固耐用, 不易生锈。
产品用途: 制造金属丝网、钉子、高速公路护栏及建筑工程捆绑丝等。

Product type: Galvanized nail
Material: Carbon steel Q195/235
Point: Strong corrosion resistance, durable, not easy to rust.
Application: wire mesh, nails, highway guardrail and construction binding wire, etc.



木托盘
Wooden pallets



电缆盘
Cable tray



木包装箱
Wood packing



大型框架
Large frame



家具装修
Furniture decoration



水泥钉
Concrete nail





ALEMİNSAN MAKİNE
www.aleminsan.com.tr

Yafes ALEMİN
CEO

T: +90 216 394 31 32
G: +90 532 795 55 89
F: +90 216 394 34 28
Mesit Mah. İlim Sk. No: 1 Orhanlı
Tuzla / İstanbul / Türkiye

ALEMİN SAN
SOĞUK TEL ÇEKME

ALEMİN SAN
KANEPE VE KOLTUK MEKANİZMA SİSTEMLERİ

ALEMİN SAN
SOĞUK ÇEKME LAMA

YETKİLİ SATIŞ EKİBİMİZ BÜLENT ALEMİN YAFES ALEMİN MERT ALEMİN DOĞUKAN ALEMİN

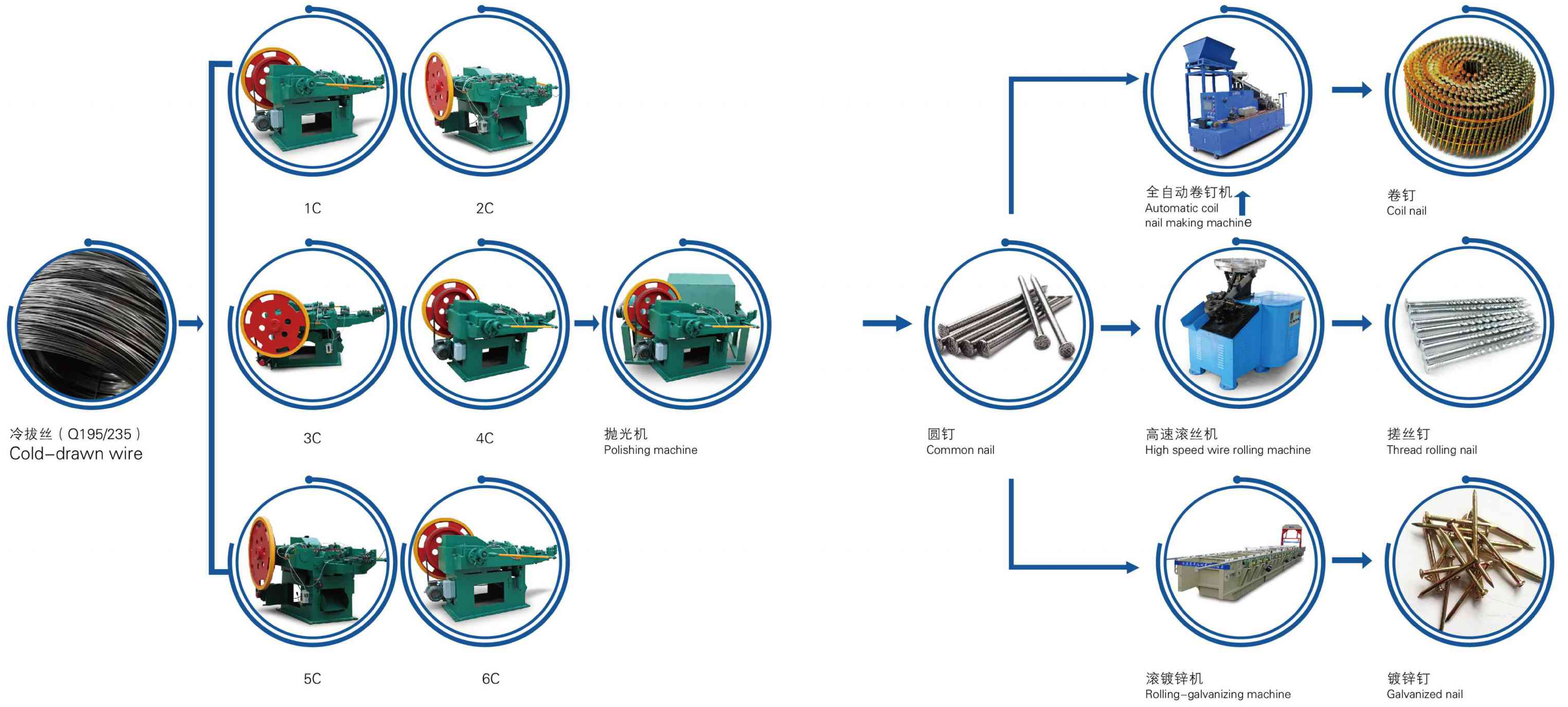



ALEMİNSAN MAKİNE
www.aleminsan.com.tr

Yafes ALEMİN
CEO

T: +90 216 394 31 32
G: +90 532 795 55 89
F: +90 216 394 34 28
Mescit Mah. İlim Sk. No: 1 Orhanlı
Tuzla / İstanbul / Türkiye



YETKİLİ SATIŞ EKİBİMİZ BÜLENT ALEMİN YAFES ALEMİN MERT ALEMİN DOĞUKAN ALEMİN

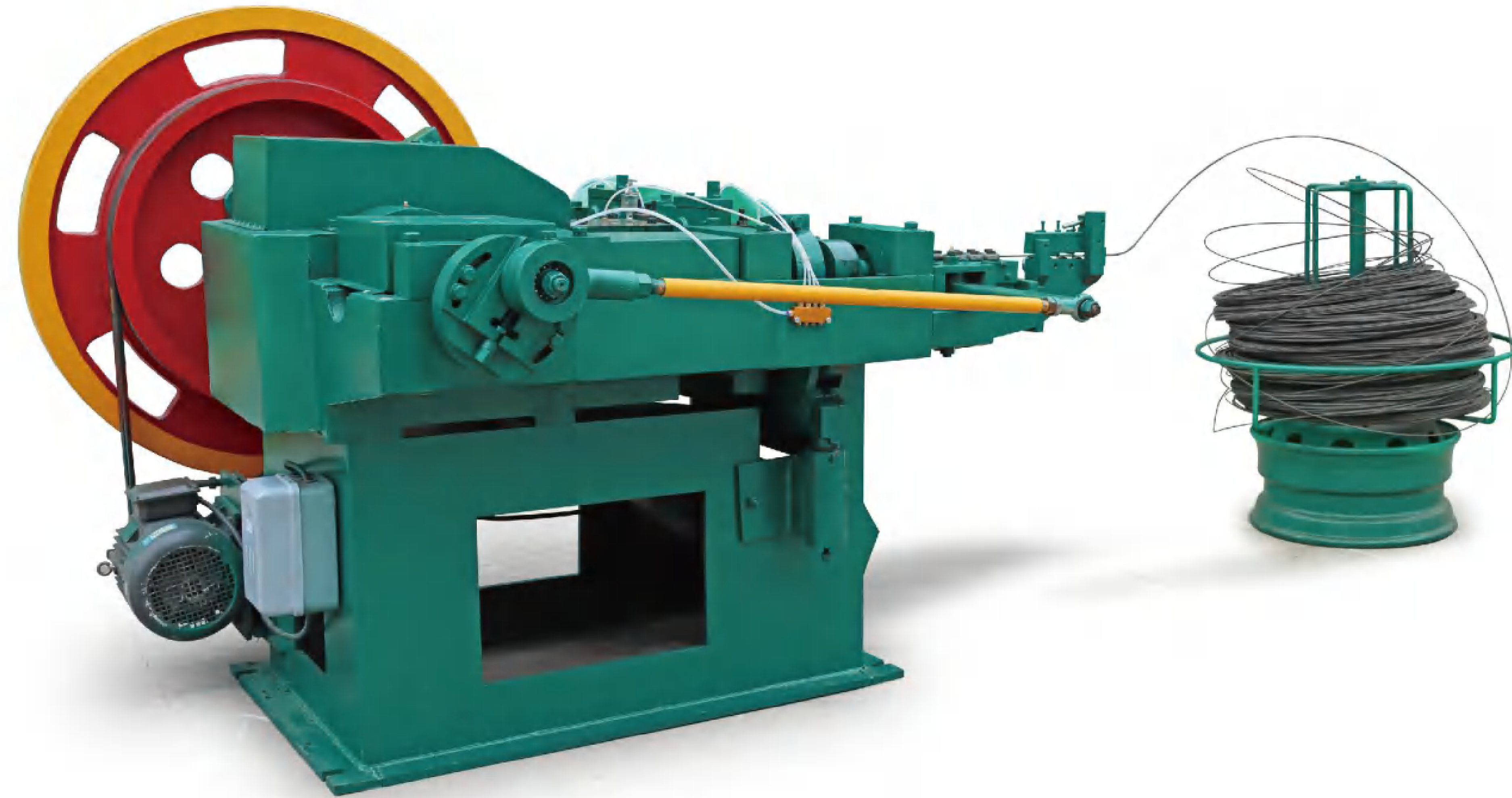

功能描述 Function:

该机采用柱塞式结构保证了高速度、低噪音、少冲声的特点。设计先进，结构紧凑，外型美观，使用方便，操作安全。

This machine adopts plunger type structure to ensure the high working speed, low noise, and less sound of impact. It has the feature of advanced design, compact conformation, and good figure. It is easy and safe to operate.

| 型号 Type | 功率 Motor power | 制钉长度 Length of nail | 制钉速度 Nail making speed | 制钉直径 Diameter of nail | 重量 Weight | 外形尺寸 Dimension |
|------------|-------------------|------------------------|---------------------------|--------------------------|--------------|-------------------|
| 1C | 1.5kw | 9~25mm | 400~450 pcs/min | 0.9~1.6mm | 900KG | 1350×950×1000 |
| 2C | 2.2kw | 16~50mm | 260~350 pcs/min | 1.2~2.8mm | 1350KG | 1650×1150×1100 |
| 3C | 2.2kw | 30~75mm | 280~320 pcs/min | 1.8~3.4mm | 1600KG | 1990×1200×1250 |
| 4C | 4kw | 50~100mm | 220~280 pcs/min | 2.8~4.5mm | 2000KG | 2280×1420×1330 |
| 5C | 5.5kw | 80~150mm | 180~200 pcs/min | 3.7~5.5mm | 2500KG | 2380×1580×1660 |
| 6C | 11kw | 150~200mm | 160~180 pcs/min | 4.5~6.5mm | 5000KG | 3500×2200×1680 |

High speed thread rolling machine



功能描述 Function:

该机配有各种专用模具，可以生产各类异型钉类，主要用于螺纹钉、环纹钉等新型钉类。

This machine is equipped with professional moulds, can produce various kinds of shaped nails. It is mainly used to produce screw nail, spiral nail and other new type of nails.

| | |
|------------------------|------------------|
| 电源电压 Voltage | 三相AC380V3 phase |
| 电机功率 Motor power | 5.5KW |
| 料斗电源 Bucket power | AC220 |
| 主轴直径 Main shaft dia | 130mm |
| 总重量 Total weight | 1300KG |
| 滚钉直径 Nail dia | 1.8-4.0mm |
| 钉身长度 Nail length | <100mm |
| 料斗下钉量 Conveying speed | 1000-1500pcs/min |
| 生产量 Capacity | 800-1300pcs/min |
| 外形尺寸 Dimrndion (L/W/H) | 1200×1600×1600mm |

全自动卷钉机 Automatic coil nail making machine



| | |
|---------------------------|-------------------------------|
| 电机功率 Motor power | 2KW |
| 焊接功率 Welding power | 6KW/V |
| 焊接电流 Welding current | 1000-2000A |
| 焊接电源 Welding source | DC290-330V |
| 工作电源 Working power | 三相three phase AC 380V 50-60HZ |
| 适用钉子直径 Nail diameter | 1.8-4.5mm |
| 适用钉子长度 Nail length | 25-100mm |
| 速度 Speed | 1250-2000Pcs/min |
| 整机重量 Total weight | 1600KG |
| 外形尺寸 Dimrndion (L/W/H) | 3800×2100×2400mm |



ALEMİNSAN MAKİNE
www.aleminsan.com.tr

Yafes ALEMİN
CEO

T: +90 216 394 31 32
G: +90 532 795 55 89
F: +90 216 394 34 28
Mesit Mah. İlim Sk. No: 1 Orhanlı
Tuzla / İstanbul / Türkiye

ALEMİN SAN
SOĞUK TEL ÇEKME

ALEMİN SAN
KANEPE VE KOLTUK MEKANİZMA SİSTEMLERİ

ALEMİN SAN
SOĞUK ÇEKME LAMA

YETKİLİ SATIŞ EKİBİMİZ BÜLENT ALEMİN YAFES ALEMİN MERT ALEMİN DOĞUKAN ALEMİN

应用范围 Range of application ●●●●●

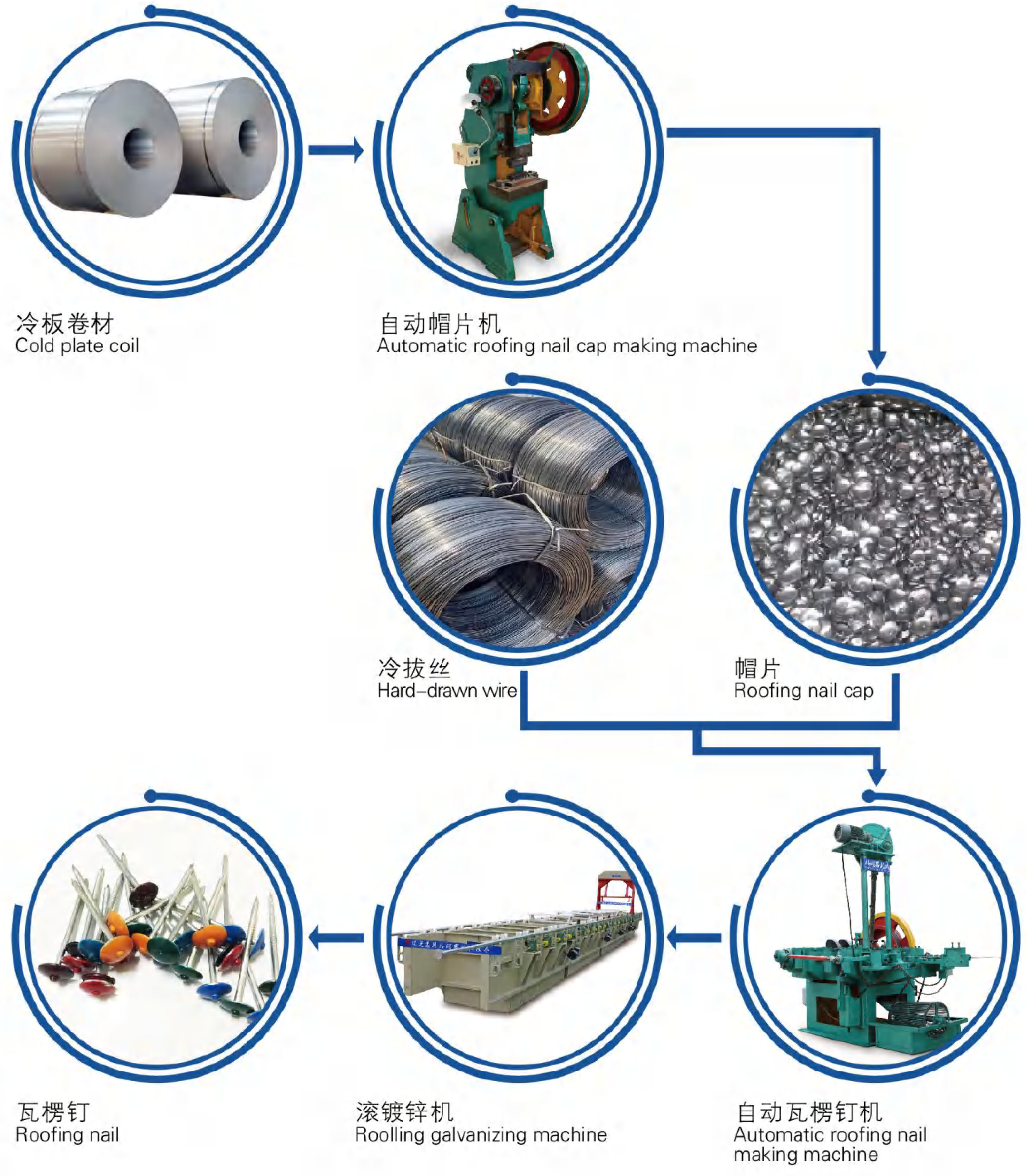

产品类型: 瓦楞钉
材质: Q195/Q235
规格: 9BWG*2 " 9BWG*2
1/2 " 10BWG*2" 10BWG*2 等
公称直径: 2.8-4.2 mm
长度: 40-80mm
特点: 硬度高、韧性好、不易生锈、无污染、耐磨防腐。
产品用途: 主要用于建筑, 连接木构件, 以及石棉瓦、塑料瓦的固定。

Product type: corrugated nails
Material: Q195/Q235
Criteria: 9BWG*2 "9BWG*2
1/2" 10BWG*2 "10BWG*2, etc
Nominal diameter: 2.8-4.2mm
Long degrees: 40-80 - mm
Point: high hardness, good toughness, not easy to rust, no pollution, wear resistance and anticorrosion.
Application: mainly used for building, connecting wood structure, and fixing asbestos tile and plastic tile.



木架装钉
Wooden frame with nail



塑料瓦固定
Plastic tile fixation



屋顶构建
Roof building



木屋搭建
Wooden structures





ALEMİNSAN MAKİNE
www.aleminsan.com.tr

Yafes ALEMİN
CEO

T: +90 216 394 31 32
G: +90 532 795 55 89
F: +90 216 394 34 28
Mescit Mah. İlim Sk. No: 1 Orhanlı
Tuzla / İstanbul / Türkiye

ALEMİN SAN
SOĞUK TEL ÇEKME

ALEMİN SAN
KANEPE VE KOLTUK MEKANIZMA SİSTEMLERİ

ALEMİN SAN
SOĞUK ÇEKME LAMA

YETKİLİ SATIŞ EKİBİMİZ BÜLENT ALEMİN YAFES ALEMİN MERT ALEMİN DOĞUKAN ALEMİN

Automatic roofing nail cap making machine

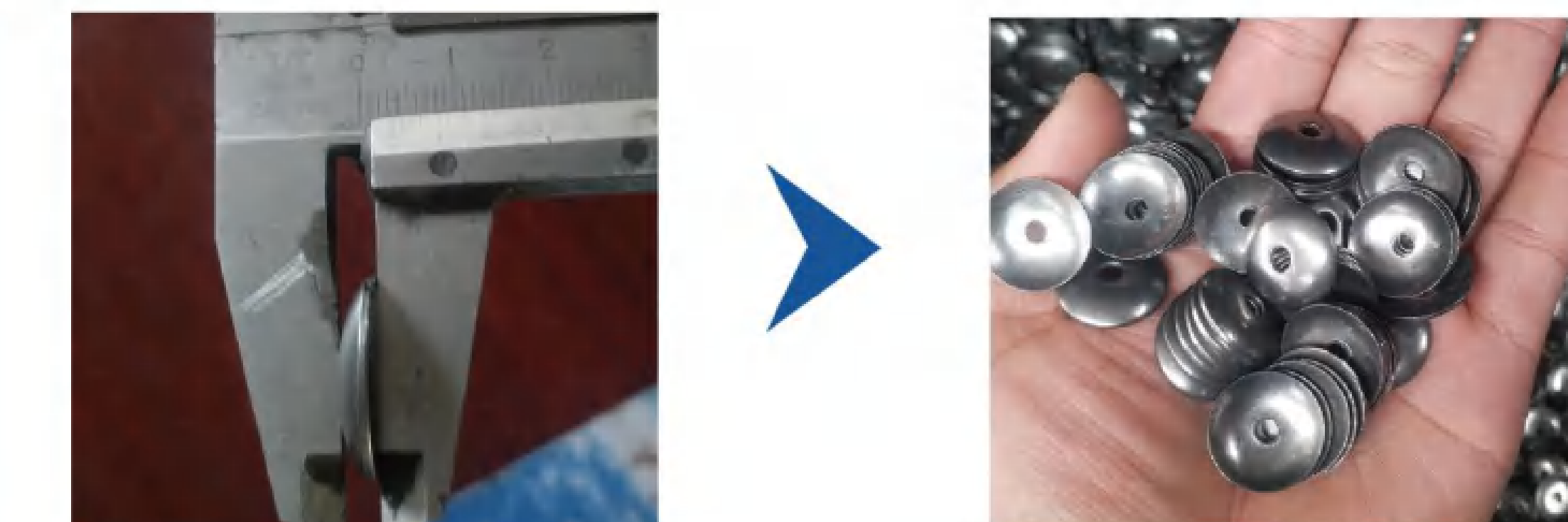

| | |
|--|-----------------|
| 生产功率 Production efficiency (pcs/min) | 6×65 |
| 电机功率 Motor power (kw) | 2.2 |
| 机器重量 Weight (kg) | 2300 |
| 外形尺寸 Dimension (mm) | 13500×1100×2200 |

| | |
|------------------------------------|----------------|
| 技术参数 Techincal data | Z94-4A |
| 制钉最大直径 Maximum nail diameter (mm) | 4.0 |
| 制钉最小直径 Minimum nail diameter (mm) | 2.38 |
| 制钉最大长度 Maximum nail length (inch) | 3" |
| 制钉最小长度 Minimum nail length (inch) | 1.5" |
| 设计产量 Designed capacity (Pcs/min) | 110-150 |
| 电动机功率 Motor power (kw) | 4.0 |
| 重量 Weight (kg) | 3000 |
| 外形尺寸 Dimension (mm) | 2800×1100×2200 |

滚镀锌机
Rolling-Galvanizing Machine

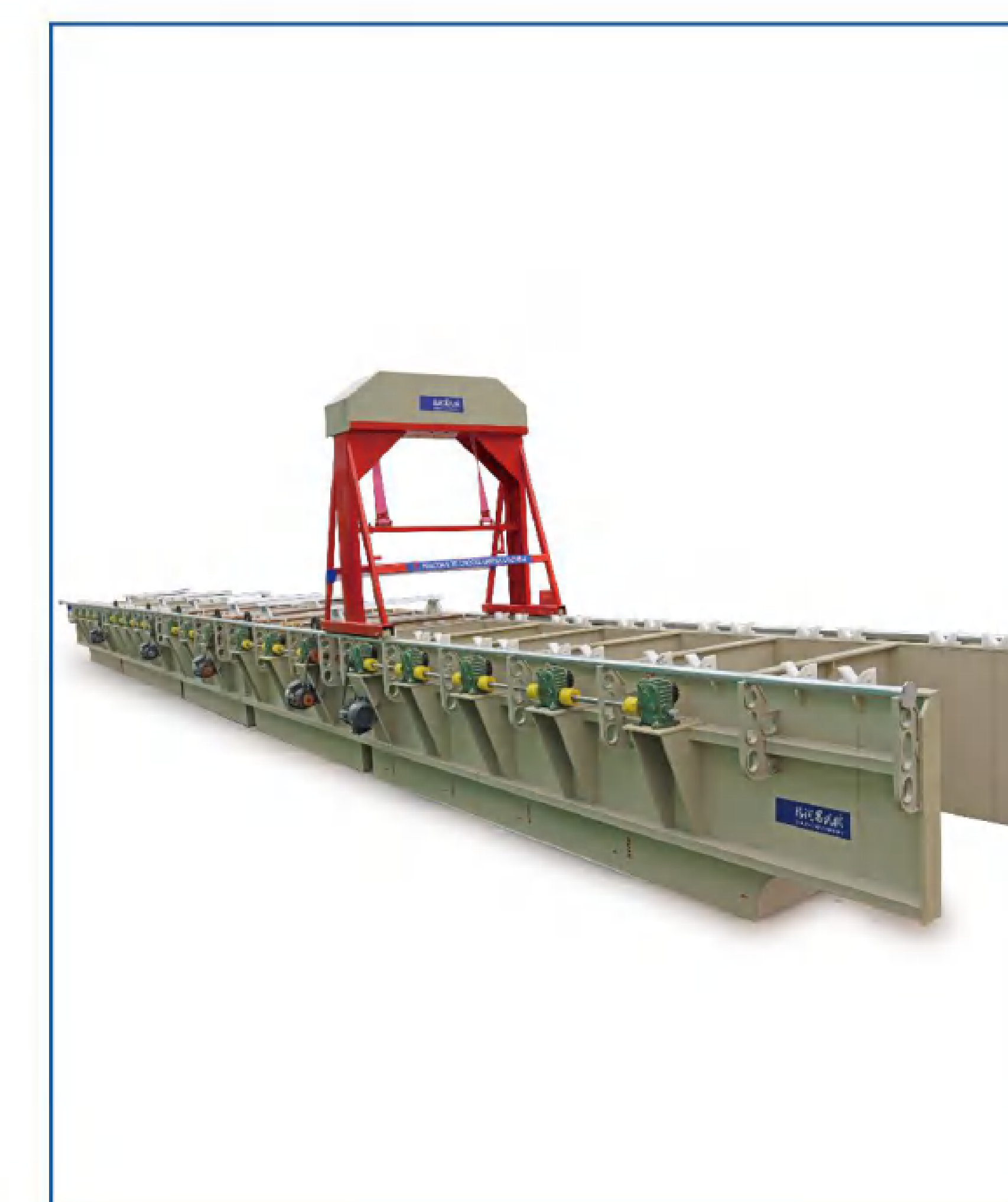

| | |
|-------------------------------|-----------------|
| 型号 Model | BGD25-1 BGD50-2 |
| 滚筒装料量 Load of roller (kg) | 50-100 |
| 时间控制范围 Time control (min) | 0-120 |
| 滚筒转速 Roller speed (r/min) | 7-9 |



ALEMİNSAN MAKİNE
www.aleminsan.com.tr

Yafes ALEMİN
CEO

T: +90 216 394 31 32
G: +90 532 795 55 89
F: +90 216 394 34 28
Mesit Mah. İlim Sk. No: 1 Orhanlı
Tuzla / İstanbul / Türkiye

ALEMİN SAN
SOĞUK TEL ÇEKME

ALEMİN SAN
KANEPE VE KOLTUK MEKANIZMA SİSTEMLERİ

ALEMİN SAN
SOĞUK ÇEKME LAMA

YETKİLİ SATIŞ EKİBİMİZ BÜLENT ALEMİN YAFES ALEMİN MERT ALEMİN DOĞUKAN ALEMİN

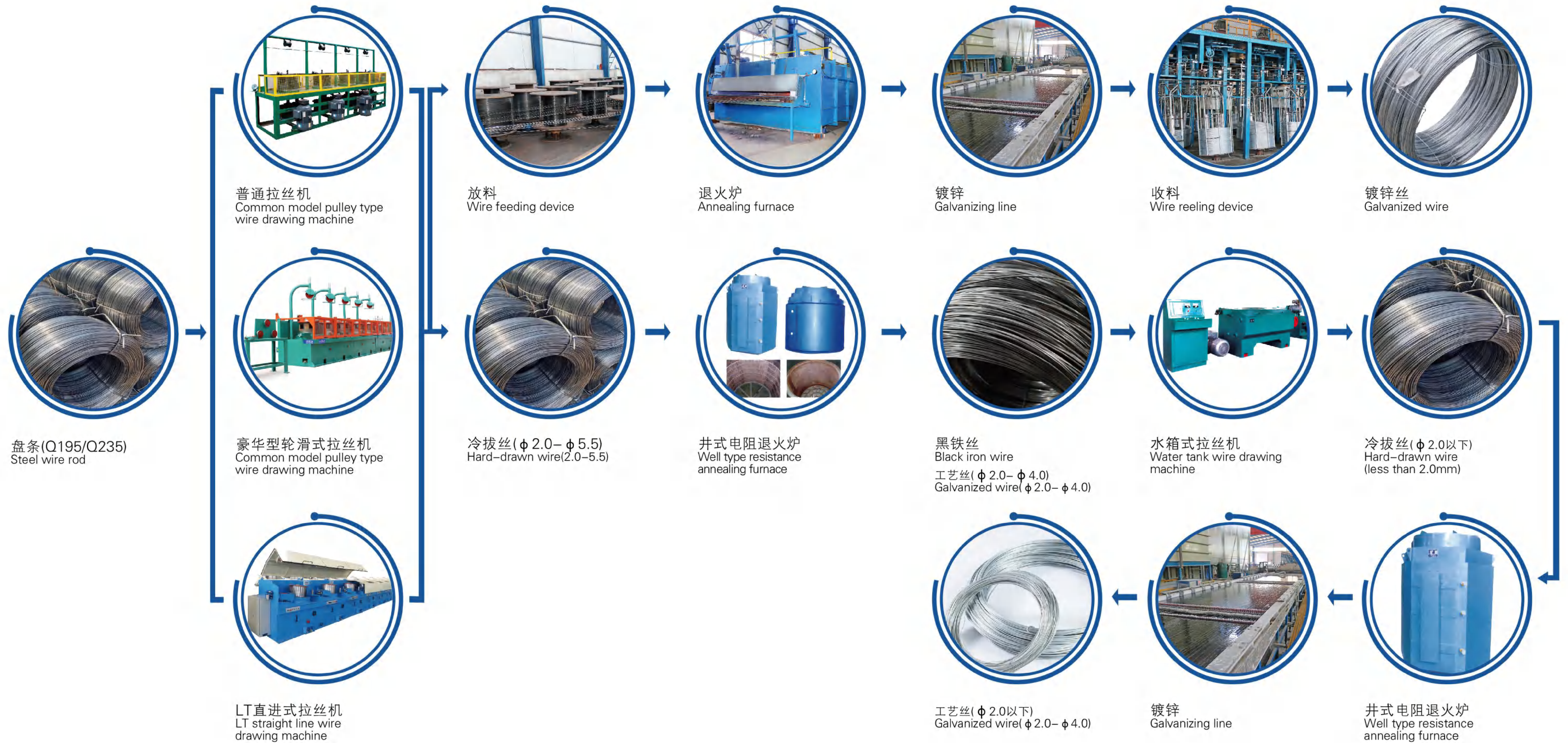



ALEMİNSAN MAKİNE
www.aleminsan.com.tr

Yafes ALEMİN
CEO

T: +90 216 394 31 32
G: +90 532 795 55 89
F: +90 216 394 34 28
Mesit Mah. İlim Sk. No: 1 Orhanlı
Tuzla / İstanbul / Türkiye



YETKİLİ SATIŞ EKİBİMİZ BÜLENT ALEMİN YAFES ALEMİN MERT ALEMİN DOĞUKAN ALEMİN

Luxurious model pulley type wire drawing machine



功能描述 Function:

该拉丝机可拉拔高、中、低碳钢及铜、铝等线材。使用于制钉丝、电工导线、铜丝绳、弹簧等制造行业。采用电气控制操作简单，噪声低，效率高。

This drawing machine can be used to draw wires of low, medium and high carbon steel, copper and aluminum. It is suitable for manufacture industries of nail wire, electric leads, copper ropes, springs, etc. Adopting electrical control, it is easy for operation, of low noise and high efficiency.

| 拉丝机技术参数Data | 五联罐Five drums | 四联罐Four drums | 三联罐Three drums | 二联罐Two drums |
|------------------------------------|---------------|---------------|----------------|--------------|
| 卷筒直径 Drum diameter (mm) | 550-600 | 550-600 | 550-600 | 550-600 |
| 最大出线 Largest outlet (mm) | 6.5 | 6.5 | 6.5 | 6.5 |
| 最小出线 Minimum qualification (mm) | 3.0 | 3.8-4.0 | 4.5 | 4.8 |
| 模具(块) Mould (pcs) | 5 | 4 | 3 | 2 |
| 线速度 Linear velocity (m/min) | 216 | 120-160 | 120-160 | 120-160 |
| 电机功率 Motor power (kw) | 60 | 45 | 35 | 27 |
| 润滑方式 Lubricant type | 粉Powder | | | |

| 型号 Model | LW1-6/350 | LW1-6/450 | LW1-6/550 | LW1-6/560 |
|-------------------------------|-----------|-----------|-----------|------------|
| 卷筒直径 Diameter of drum (mm) | 350mm | 450mm | 550mm | 560mm |
| 最大进线直径 Max inlet dia (mm) | 2.6-1.5mm | 4mm | 6.5mm | 6.5-4.4mm |
| 最小出线直径 Min outlet dia (mm) | 1.2-0.7mm | 1.6mm | 2.2mm | 2.5-1.76mm |
| 成品出线速度 Speed | 227m/min | 280m/min | 294m/min | 300m/min |
| 单机功率 Single power | 5.5kw | 7.5-15kw | 18.5-22kw | 18.5-22kw |
| 单机重量 Single weight (kg) | 770kg | 1100kg | 1400kg | 2000kg |



ALEMINSAN MAKİNE
www.aleminsan.com.tr

Yafes ALEMİN
CEO

T: +90 216 394 31 32
G: +90 532 795 55 89
F: +90 216 394 34 28
Mescit Mah. İlim Sk. No: 1 Orhanlı
Tuzla / İstanbul / Türkiye

ALEMİN SAN
SOĞUK TEL ÇEKME

ALEMİN SAN
KANEPE VE KOLTUK MEKANİZMA SİSTEMLERİ

ALEMİN SAN
SOĞUK ÇEKME LAMA

YETKİLİ SATIŞ EKİBİMİZ BÜLENT ALEMİN YAFES ALEMİN MERT ALEMİN DOĞUKAN ALEMİN

Water tank wire drawing machine



功能描述 Function:

该设备适用于拉拔各种钢丝、焊丝等各种金属线材。
This device is used to draw various kinds of steel wire, welding wire and other metal wire materials.



| | | | | | | | | | |
|----------------------------|----------|-------|-------|-------|-------|-------|-------|-------|--------|
| 拉拔道次 Times of drawing | 2-11 | 2-11 | 2-11 | 2-12 | 2-12 | 2-12 | 2-12 | 2-9 | 2-9 |
| 卷筒直径 Drum dia (mm) | 300 | 350 | 400 | 450 | 500 | 560 | 600 | 700 | 800 |
| 最大进线直径 Max inlet dia (mm) | 2.8 | 3.5 | 4.2 | 5 | 5.5 | 6.5 | 8 | 10 | 12.7 |
| 最小出线直径 Min outlet dia (mm) | 0.5 | 0.6 | 0.75 | 1 | 1.2 | 1.4 | 1.6 | 2.2 | 2.6 |
| 成品出线速度 Speed (m/s) | 25 | 20 | 20 | 16 | 15 | 15 | 12 | 12 | 8 |
| 单机功率 Single power | 7.5-18.5 | 11-22 | 11-30 | 15-37 | 22-45 | 22-55 | 30-75 | 45-90 | 55-110 |
| 进线强度 Input strength (MPA) | ≤1250 | | | | | | | | |

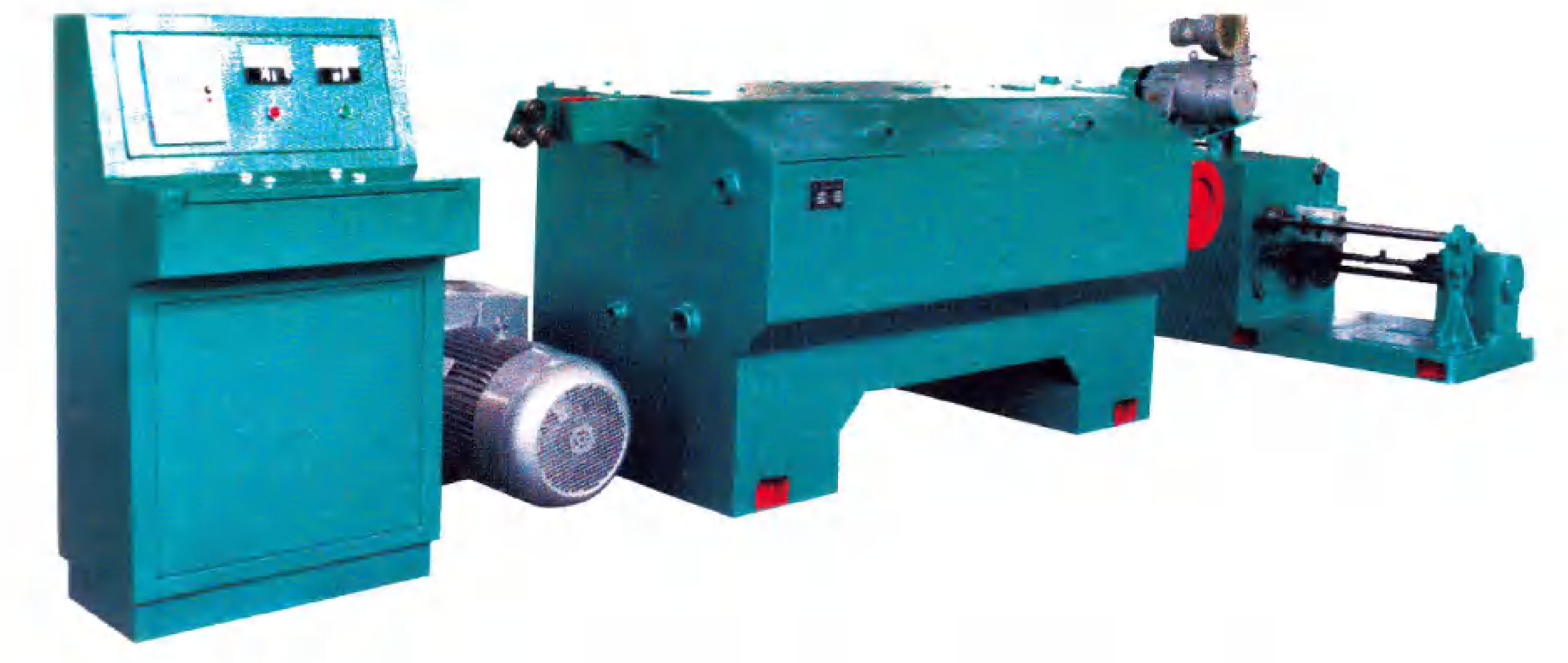

| | | | | | |
|-----------------------|----------------|----------------|----------------|----------------|----------------|
| 参数 Data | LT2-17/280 | LT1-11/350 | LT1-9/450 | LT1-12/350 | LT1-9/560 |
| 卷筒直径 Drum dia | 280mm | 350mm | 450mm | 350mm | 560mm |
| 拉拔模个数 Number of mould | 17个 | 11个 | 9个 | 12个 | 9个 |
| 进线直径 Inlet dia | 2.5-2.0mm | 2.8-2.5mm | 3.4-3.0mm | 2.2mm | 4.7mm |
| 出线直径 Outlet dia | 0.9-0.45mm | 1.4-1.2mm | 1.8-1.6mm | 0.7mm | 1.6mm |
| 拉拔速度 Speed | 500-650m/min | 160-350m/min | 160-300m/min | 250-400m/min | 280-300m/min |
| 配用电机 Motor | 22-30kw | 30-45kw | 37-45kw | 15-18.5kw | 110kw |
| 外形尺寸 Dimension | 3000*1300*1100 | 2400*1400*1200 | 3000*1500*1200 | 2400*1100*1100 | 3500*1500*1200 |
| 重量 Weight | 4200kg | 3300kg | 4000kg | 4800kg | 4000kg |

工字轮收线机
Spool reeling machine

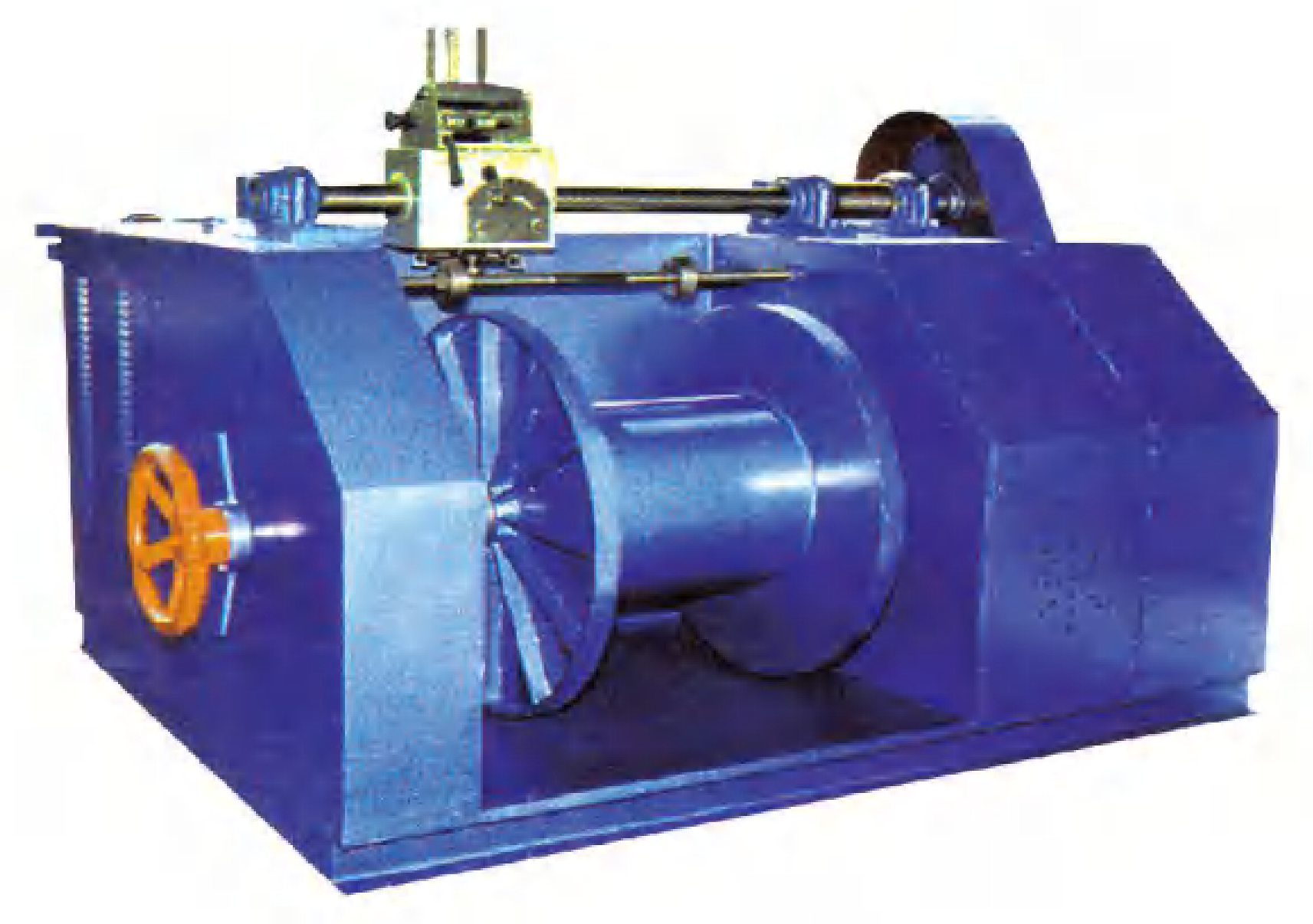

| | | |
|---------------------|------------------|-----------------|
| 收线直径 Reeling dia | 1.5-3mm | 1.2-0.9mm |
| 固定卷筒直径 Drum dia | 630mm | 400mm |
| 收线重量 Reeling weight | 300-500kg | 150-300kg |
| 收线速度 Reeling speed | 600m/min | 600m/min |
| 配套电机 Motor | YLJ160-10-4 | YLJ132-25-4 |
| 外形尺寸 Dimension | 1250*1200*1000mm | 1000*1000*800mm |
| 整机重量 Total weight | 1200KG | 900KG |

象鼻式收线机
Elephant nose type reeling machine



| | |
|--------------------------------|----------------|
| 收线直径 Reeling dia | 1.6-4mm |
| 固定卷筒直径 Drum dia | 600mm |
| 收线抗拉强度 Strength | ≤800MPA |
| 收线重量 Reeling weight | 800-1000KG |
| 精拉模压缩率 Mould compression ratio | ≤12% |
| 收线速度 Reeling speed | 150-300m/min |
| 配套电机 Motor | 6/15-18.5KW |
| 外形尺寸 Dimension | 2917×1470×2100 |
| 整机重量 Total weight | 2300KG |





ALEMINSAN MAKİNE
www.aleminsan.com.tr

Yafes ALEMİN
CEO



T: +90 216 394 31 32
G: +90 532 795 55 89
F: +90 216 394 34 28
Mesit Mah. İlim Sk. No: 1 Orhanlı
Tuzla / İstanbul / Türkiye







YETKİLİ SATIŞ EKİBİMİZ BÜLENT ALEMİN YAFES ALEMİN MERT ALEMİN DOĞUKAN ALEMİN

In-line annealing furnace



功能描述Function:

本机主要由减速器、卷筒、传动轴、机架、油槽、导丝轮等部件组成。传动由电机带动减速机作初减速，然后经链轮达到规定转速。主要用于收卷镀锌铁丝。

This machines mainly consists of reducer, drum, transmission shaft, framework, guide wheel, etc. the motor drives the reducer for primary speed-reduction, then the specified speed can be obtained via chain wheel. It is mainly used to reel galvanized iron.

| | |
|-------------------------------|----------------|
| 卷筒直径 Diameter of drum (mm) | 300-360mm |
| 卷筒个数 Drum numbers | 24-40 |
| 收线直径 Diameter of reeling (mm) | 0.4-1.2 |
| 收线速度 Reeling speed (m/min) | 45m/min-75 |
| 电机 Motor | Y160m-6-7.5 |
| 减速机 Speed reducer | JZQ350-2-2Z |
| 外形尺寸 Size (mm) | 9493×2810×1635 |
| 重量 Weight (kg) | 3600 |

功能描述Function:

该设备可选用煤或天然气作为燃料，节能环保。

The equipment can choose coal or natural gas as fuel, clean energy and environmental protection.

| | |
|---------------------|----------------------|
| 容量 Capacity | 30~60 pcs |
| 产量 Production | 4~6 t/h |
| 耗气量 Gas consumption | 22 m³/t |
| 速度 Speed | 50 m/min |
| 净量 Weight | 80000 kg |
| 外形尺寸 Size | 25000 *2000*26000 mm |



ALEMINSAN MAKİNE
www.aleminsan.com.tr

Yafes ALEMİN
CEO

T: +90 216 394 31 32
G: +90 532 795 55 89
F: +90 216 394 34 28
Mesat Mah. İlim Sk. No: 1 Orhanlı
Tuzla / İstanbul / Türkiye



YETKİLİ SATIŞ EKİBİMİZ BÜLENT ALEMİN YAFES ALEMİN MERT ALEMİN DOĞUKAN ALEMİN

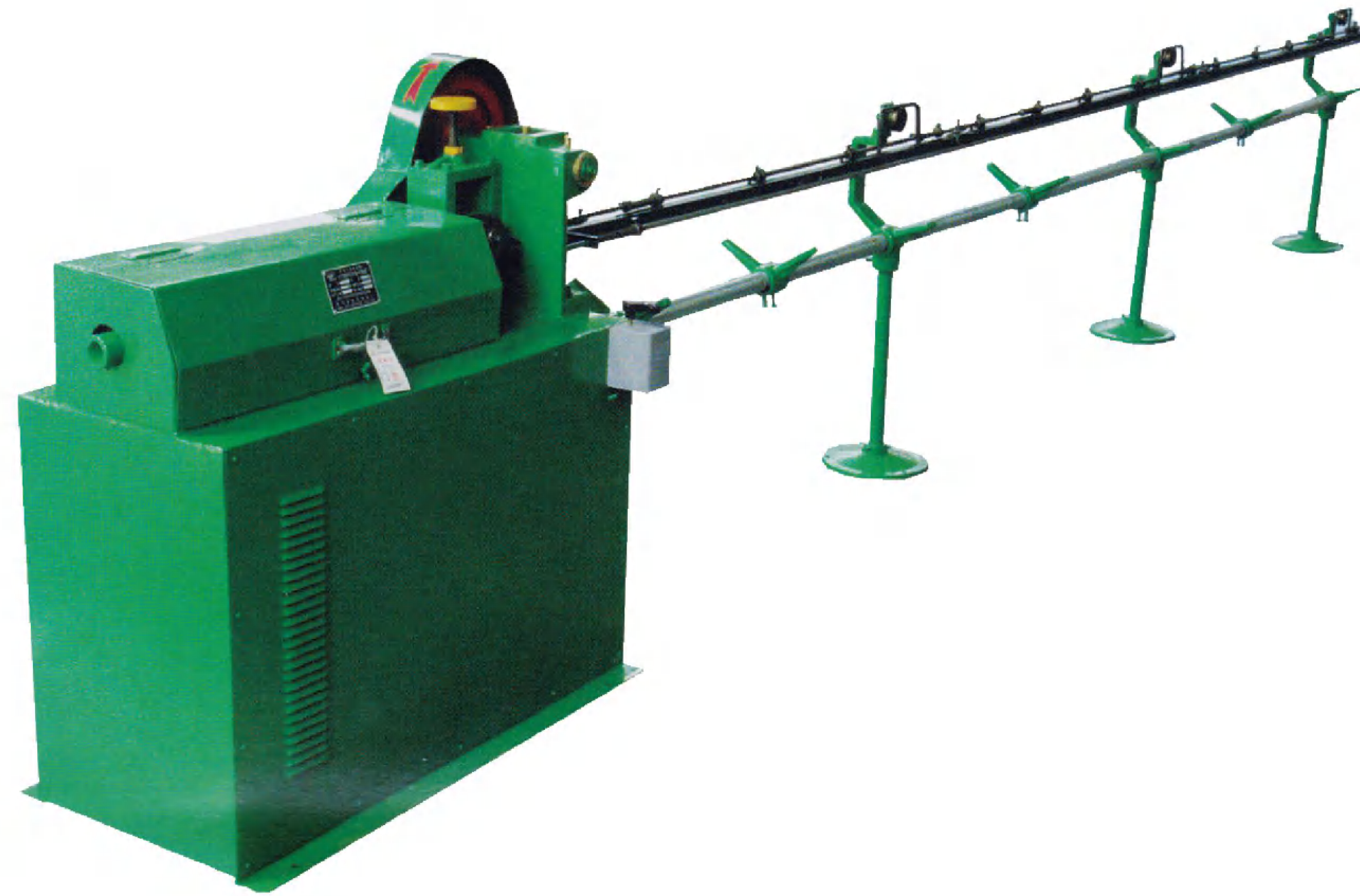

| | | | |
|--------------------------|----------------|------------------|-----------------|
| 调直钢筋直径 Wire Dia | 1-4mm | 4-8mm | 4-14mm |
| 自动切断长度 Cutting length | 30-2000mm | 200-6000mm | 300-8300mm |
| 切断长度误差 Cutting error | 1% | 1% | 1% |
| 调直速度 Straightening speed | ≥25m/min | ≥35m/min | ≥54m/min |
| 调直电机 Straightening motor | 0.75kw | 4kw | 5.5kw |
| 切断电机 Cutting motor | 0.55kw | 3kw | 4kw |
| 外形尺寸 Dimension | 1700×350×850mm | 7300×600×1240 mm | 9100×986×1365mm |
| 整机重量 Total weight | 150kg | 650kg | 1300kg |

抛光机
Polishing machine



功能描述Function:

该机主要用于各种钉子表面的除锈抛光作业。
This machine is mainly used to polish the surface rust to various kinds of nails.

| 型号 Model | 容量 Capacity | 电机功率 Motor power | 外形尺寸 (mm) Dimension (mm) |
|----------|-------------|------------------|--------------------------|
| 300 | 300kg | 2.2kw | 1700*1300*1500 |
| 600 | 600kg | 3kw | 2000*1300*1500 |
| 1000 | 1000kg | 4kw | 2400*1300*1500 |
| 1700 | 1700kg | 5.5kw | 3000*1500*1500 |
| 2000 | 2000kg | 7.5kw | 3200*1700*1700 |

钢排钉粘结机
Steel nail gluing forming machine

可自动粘结ST18-ST64各规格并且烘干按需要个数切片一次完成。
Automatic bonded all the specification from ST18 TO ST64, and in the drying section, the slice can be finished by one time according to the number of need.

功能描述Function:

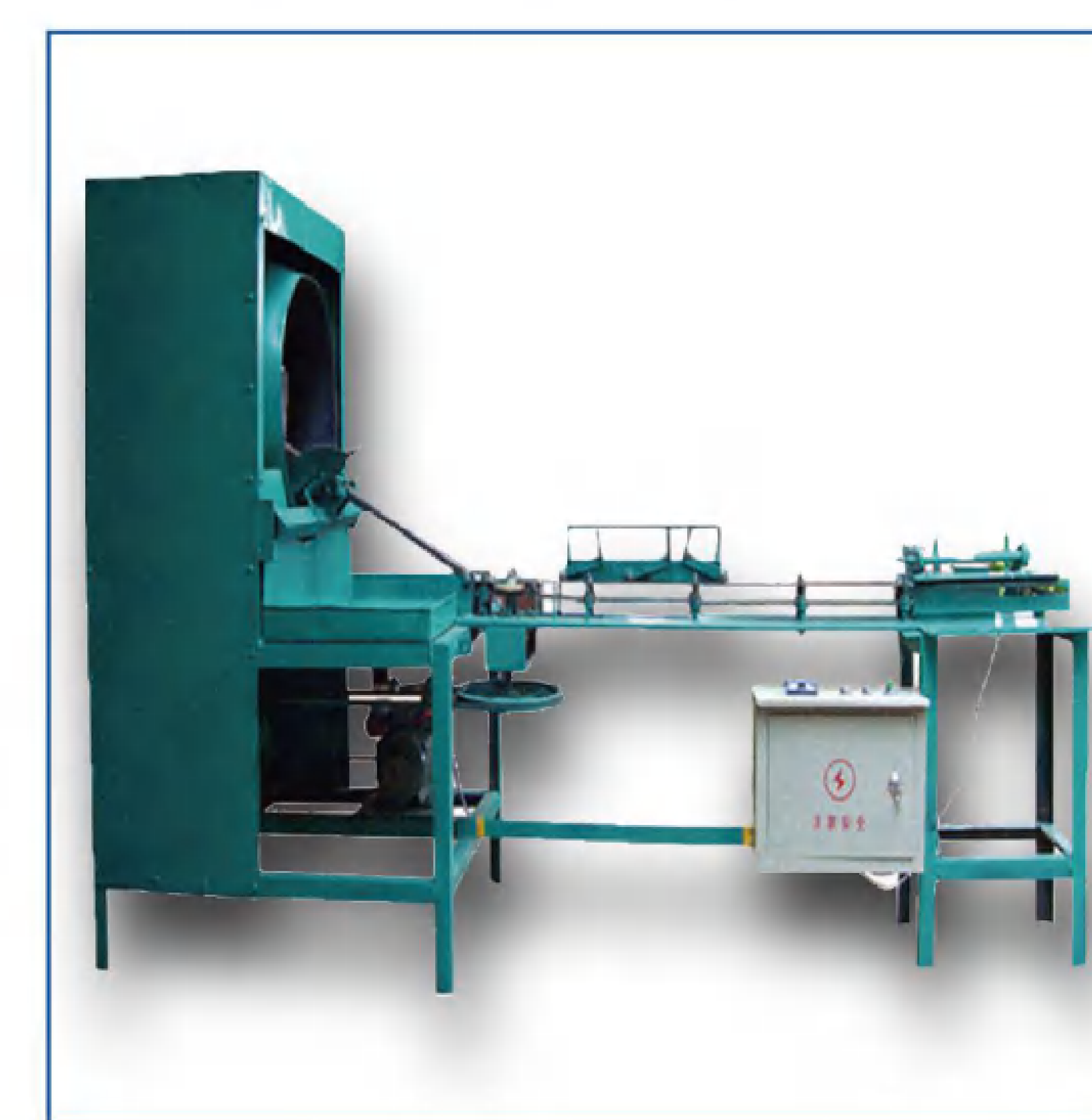

| | |
|-------------------|---|
| 型号 Model | PD-B |
| 配套动力 Power | 380V、0.75KW |
| 滚桶直径与转速 Diameter | φ770、12-15min/r |
| 轨道长度 Track length | 1.45m |
| 排钉范围 Range | 17-64mm |
| 外形尺寸 Dimension | 2450*700*1650mm |
| 效率 Efficiency | 1-3万只/小时 10thousand to 35 thousand pieces/hour |



ALEMİNSAN MAKİNE
www.aleminsan.com.tr

Yafes ALEMİN
CEO

T: +90 216 394 31 32
G: +90 532 795 55 89
F: +90 216 394 34 28
Mescit Mah. İlim Sk. No: 1 Orhanlı
Tuzla / İstanbul / Türkiye



YETKİLİ SATIŞ EKİBİMİZ BÜLENT ALEMİN YAFES ALEMİN MERT ALEMİN DOĞUKAN ALEMİN



C型制钉机
Steel nail gluing forming machine



裘皮钉
Nail fur



夹码钉机
Clip yards nail machine



自动磨刀机
Nail cutter grinder



D型钉机
Type D nail machine



轧头机
Heading rolling machine



轧尖穿模机
Heading rolling and inserting machine



对焊机
Butt welding machine



打头模具
Heading molds

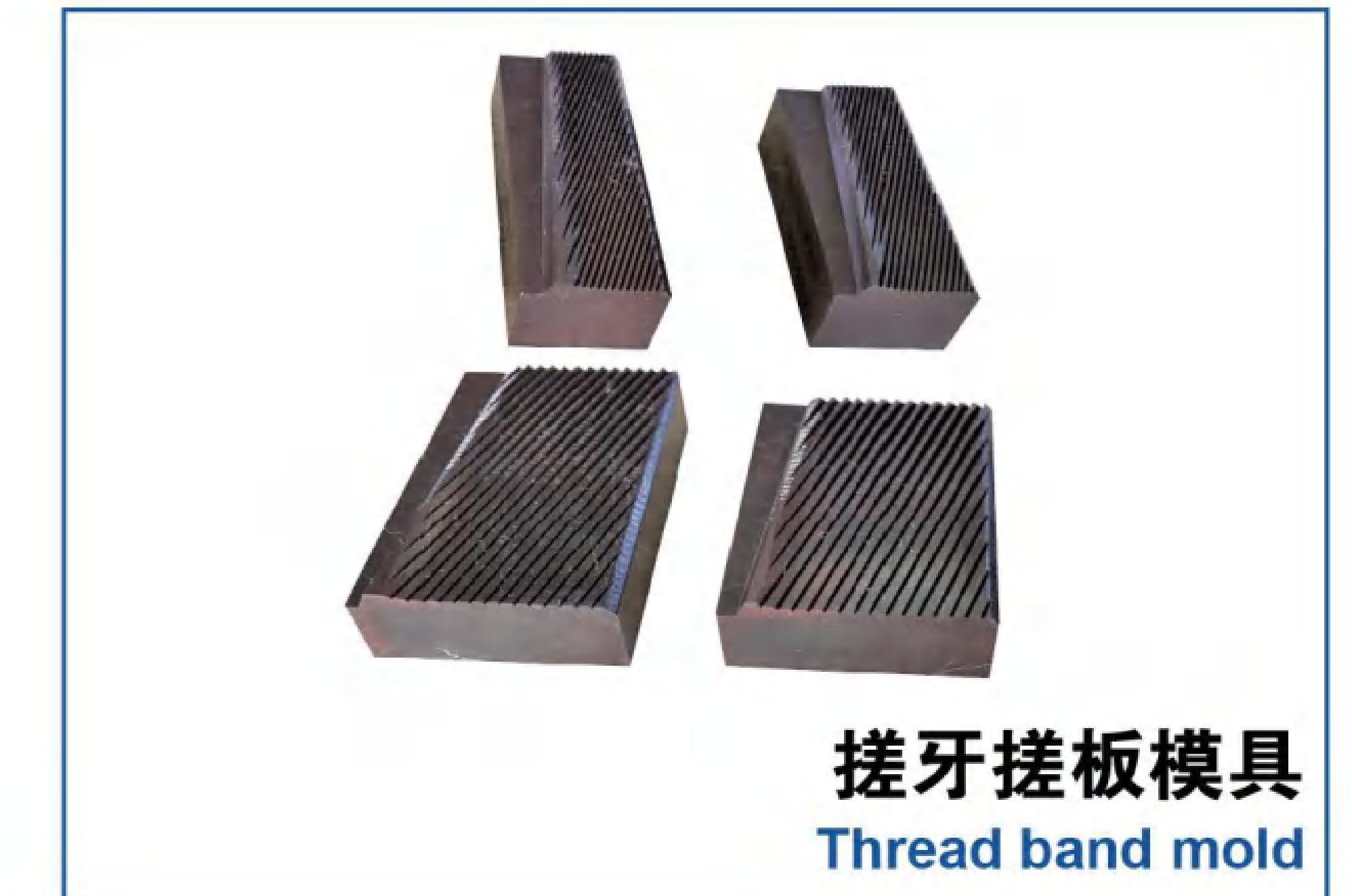

搓牙搓板模具
Thread band mold



制钉磨具
Nail mold



圆盘拉丝磨具
Round wire drawing mold