



ALEMİNSAN MAKİNE
www.aleminsan.com.tr

Yafes ALEMİN
CEO

T: +90 216 394 31 32
G: +90 532 795 55 89
F: +90 216 394 34 28
Mescit Mah. İlim Sk. No: 1 Orhanlı
Tuzla / İstanbul / Türkiye



应用范围 Range of application ●●●●●

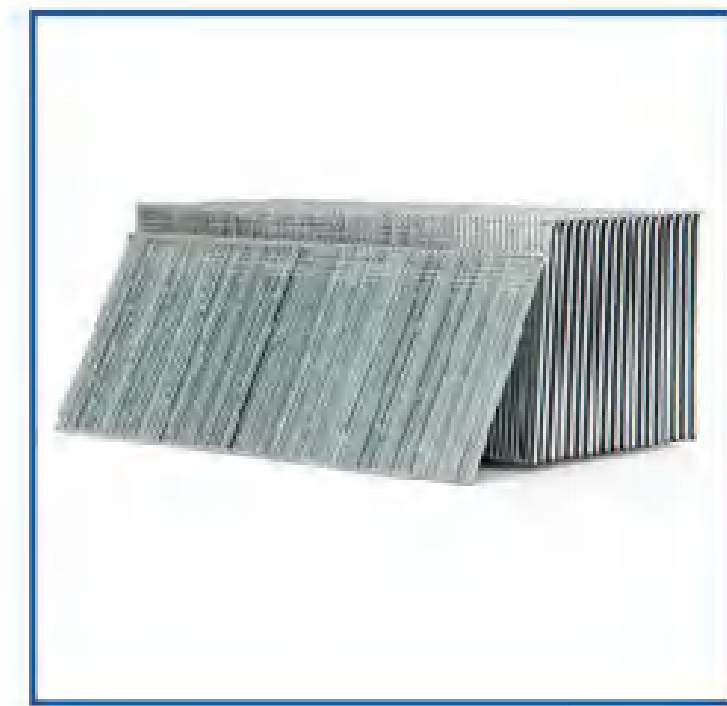

产品型号: F钉
线材 ϕ : 1.02-1.03mm
厚度: 0.82-0.83mm
产品用途: 木制家具、固定牵引、修理站台、木屋、连接箱子、盒子等钉合。
适用钉枪: 直钉枪
规格型号: F10/F15 /F20/F25/F30

Product model: F nail
Wire ϕ : 1.02-1.03mm
Thickness: 0.82 to 0.83mm
Product use: wooden furniture, fixed traction, repair platform, wooden house, connecting boxes, boxes, etc.
Nail gun: straight nail gun
Specification : F10/F15 /F20/F25/F30



产品型号: T钉
线材 ϕ : 1.40mm
厚度: 1.15-1.16mm
产品用途: 木制家具、固定牵引、修理站台、木屋、连接箱子、盒子等钉合。
适用钉枪: 直钉枪
规格型号: T25/T32/T45/T57/T64(不常用)

Product model: T nail
Wire ϕ : 1.40mm
Thickness: 1.15 to 1.16mm
Product use: wooden furniture, fixed traction, repair platform, wooden house, connecting boxes, boxes, etc.
Nail gun: straight nail gun
Specification :T25/T32/T45/T57/T64(Uncommonly used)



产品型号: N钉
线材 ϕ : 1.45-1.46mm
厚度: 1.15-1.16mm
产品用途: 装饰、家具、围栏、木屋顶、木盒、箱体包装等钉合。
规格型号: N13 (825) /N15 (832) /N17 (838) /N19 (845) /N21 (850)

Product model: N nail
Wire ϕ : 1.45-1.46mm
Thickness: 1.15 to 1.16mm
Product use: decoration, furniture, fence, wooden roof, wooden box, box packaging etc.
Specifications: N13 (825) /N15 (832) /N17 (838) /N19 (845) /N21 (850)



产品型号: 4K系列码钉
线材 ϕ : 1.19-1.20mm
厚度: 0.94-1.0mm
产品用途: 家具制造业中对沙发椅上沙发布或皮的连接, 装潢业用于天花板、薄板等。
适用钉枪: 适合各种牌子钉枪, 如美特。
规格型号: 422K/428K/432K/438K

Product model: 4K series staple nail
Wire ϕ : 1.19-1.20mm
Thickness: 0.94 to 1.0mm
Product use: Furniture manufacturing industry for sofa and chair sand release or leather connection, upholstery for ceiling, thin plate and so on.
Suitable for nail gun: suitable for various brands of nail gun, such as Mette.
Specification: 422K/428K/432K/438K



产品型号: 10J系列钉
线材 ϕ : 0.88mm
厚度: 0.54-0.56mm
产品用途: 室内家具与装饰、铺设地板、连接横梁和各种框架、固定牵引等。
规格型号: 1006J/1008J/1010J/1013J/1016J

Product model: 10J series staple nails
Wire ϕ : 0.88mm
Thickness: 0.54 to 0.56mm
Product use: indoor furniture and decoration, laying floor, connecting beam and various frames, fixed traction, etc.
Specifications: 1006j / 1008j / 1010j / 1013j / 1016j

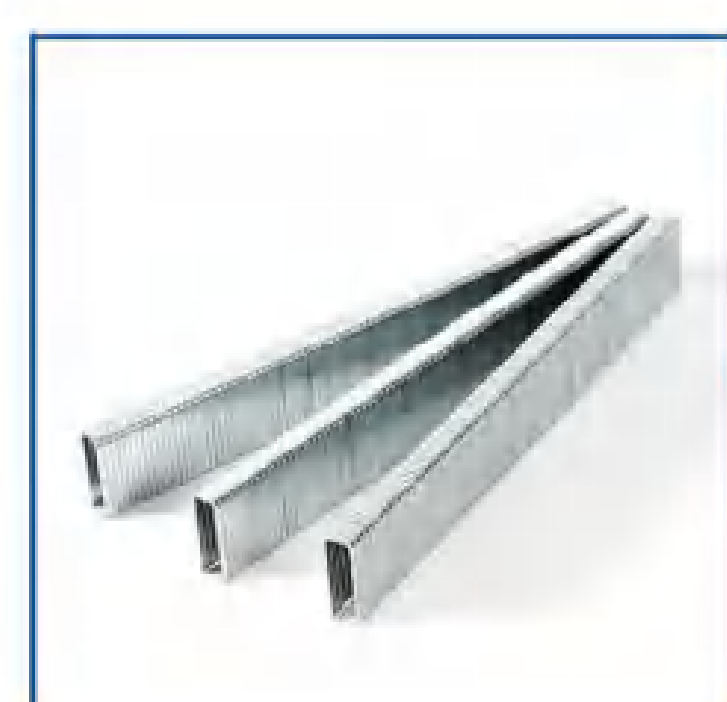

型号: 4J码钉
线材 ϕ : 0.88mm
厚度: 0.54-0.56mm
产品用途: 装饰、家具、门窗、箱框、围栏、木屋顶、木盒、制鞋、皮革及用于其他钉合。
规格型号: 404J、405J、406J、408J、410J、413J、416J、419J、422J

Model: 4J staple nail
Wire ϕ : 0.88mm
Thickness: 0.54 to 0.56mm
Product use: decoration, furniture, doors and Windows, boxes, fences, wooden roof, wooden box, shoes, leather and other stitching.
Specifications: 404J, 405J, 406J, 408J, 410J,



细木工装潢制作
Joinery packaging production



篱笆固定
Fixed the fence



沙发布料的钉合
The stitching of the fabric on the sofa



钉货架
Nail shelves





气排钉主要用于制造气动钉产品，其适用于各种装潢装修、木制家具、造鞋业等行业。该气动钉经专用气动工具连续击打，将其打入木材，是目前唯一取代传统手锤打铁的先进产品。能使以上各行业数倍地提高生产效率，节省劳动力，加快工作进度。

Pneumatic staple pin is mainly used for manufacturing pneumatic nail products, which is suitable for all kinds of decoration, wooden furniture, shoe industry and other industries. The pneumatic nail is continuously hit by special pneumatic tools to drive it into wood, which is the only advanced product to replace the traditional hand hammer. Can make the above industries several times to improve production efficiency, save labor, speed up the progress of work.



用于上胶拼线，制作成线板，再将线板制造成各种气动钉类产品。

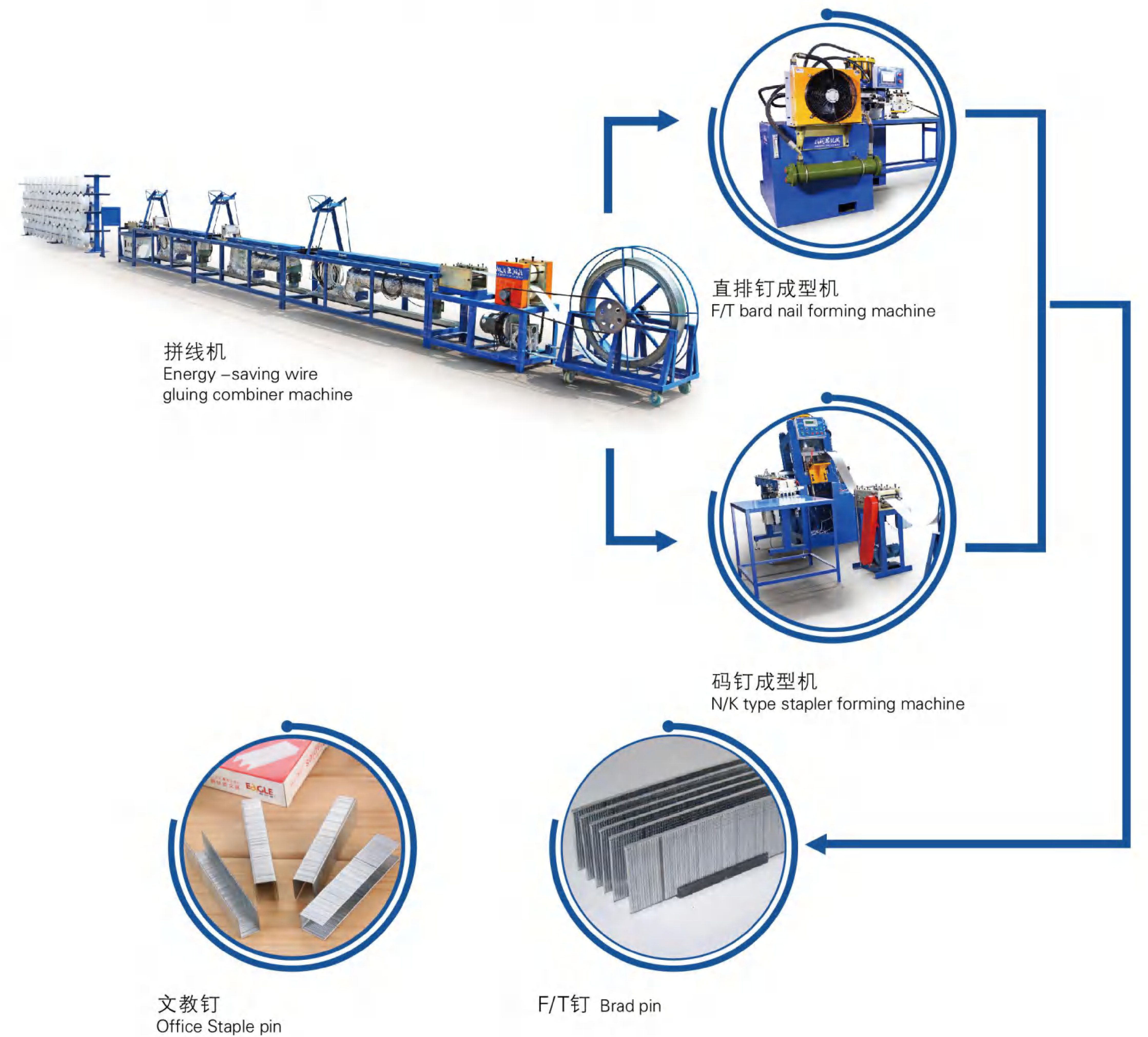

Used for gluing line, made into wire band, and then the wire band into a variety of pneumatic nail products.



压扁机 (标准型压扁机)
Wire flattener (Standard flattening machine)

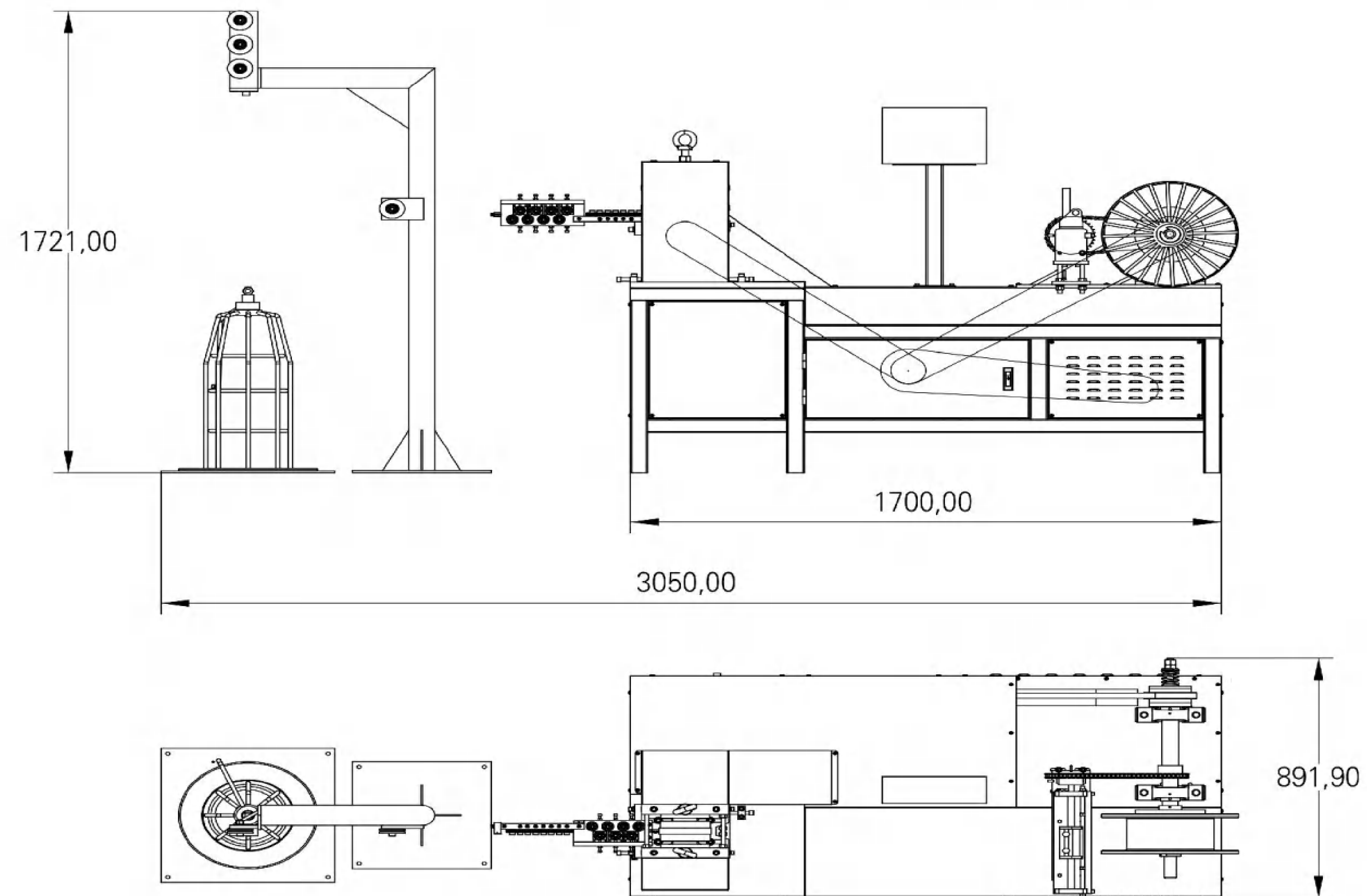

Wire flattener
(Double wheel flattening machine)



功能描述 Function:

采用硬度高合金进口材质压轮, 保证压扁精度, 配备高精度自动摆线器, 保证收线均匀, 整机可采用电磁调速变频调速。

It adopts high hardness alloy wheel, to make sure flatter accuracy. It is equipped with high accuracy automatic cycloid, to make sure rewinding uniform, The whole machine can use electromagnetic or frequency speed control.

功率Motor power	4kW (双压扁) 4KW (Double pressed)
	3kW (单压扁) 3KW (Single flattening)
速度Speed	10-350 m/min
压线范围Wire flattening range	0.4-2mm
重量Weight	500KG
外形尺寸Dimension (L/W/H)	2500*1100*1800mm

水箱式拉丝压扁机
Water tank wire drawing & flattening machine



功能描述 Function:

本机为拉丝及压扁功能一体机, 压轮可配备Φ150mm或Φ200mm水冷却压轮随意选择, 整机采用变频器同步控制速度, 配备高精度自动摆线器。

This machine has wire drawing and flattening function together. Flatten wheel can be Φ150mm or Φ200mm. The whole machine adoptd frequency converter synchronous control speed, equipped with high precision automatic cycloid.

功率Motor power	30+2.2KW
速度Speed	10-450 m/min
压线范围Wire flattening range	0.4-2.2mm
重量Weight	2000KG
外形尺寸Dimension (L/W/H)	2800*1500*1800mm

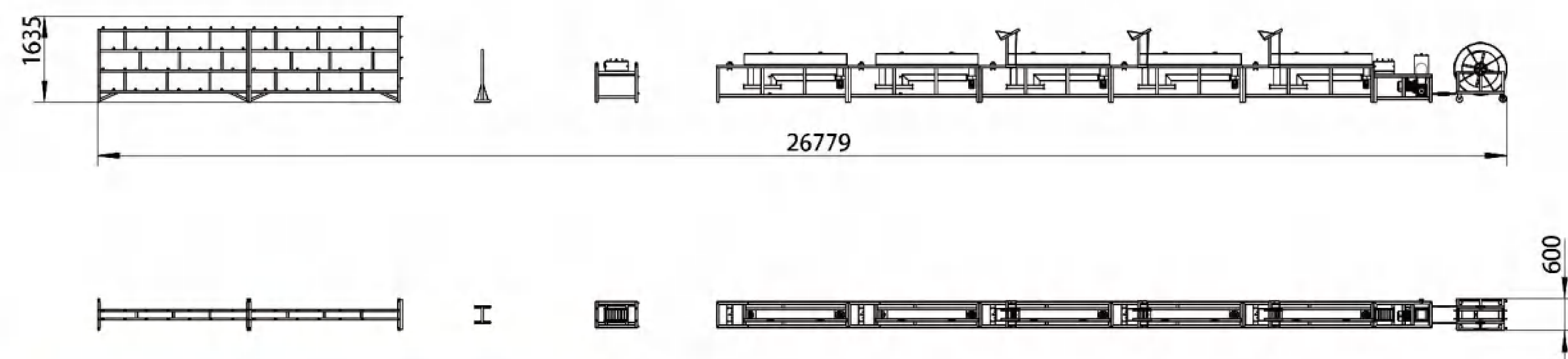

功能描述Function:

电磁型加热上胶拼线机是一种风冷、水冷双冷却系统设备，高效节能，可加装断丝自动停车功能的节能式上胶拼线机。设备总长可根据客户需求来设定。

Electromagnetic heating gluing and stitching machine is a kind of air cooling and water cooling double cooling system equipment, high efficiency and energy saving, can be equipped with broken wire automatic stop function of energy-saving gluing and stitching machine. Total length of equipment can be set according to customer requirements.

功率 Motor power	18KW
速度 Speed	6-20m/min
拼线宽度 Combining width	50-150mm
重量 Weight	1500KG
外形尺寸 Dimension	2500*1000*1700mm

F/T 直排成型机 F/T brad pin nail forming machine

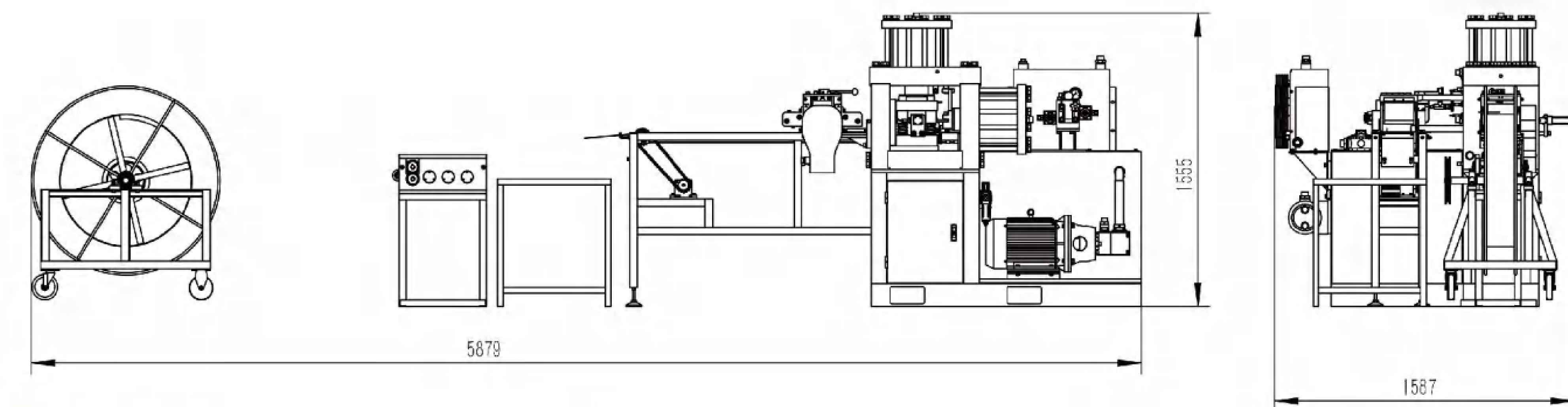
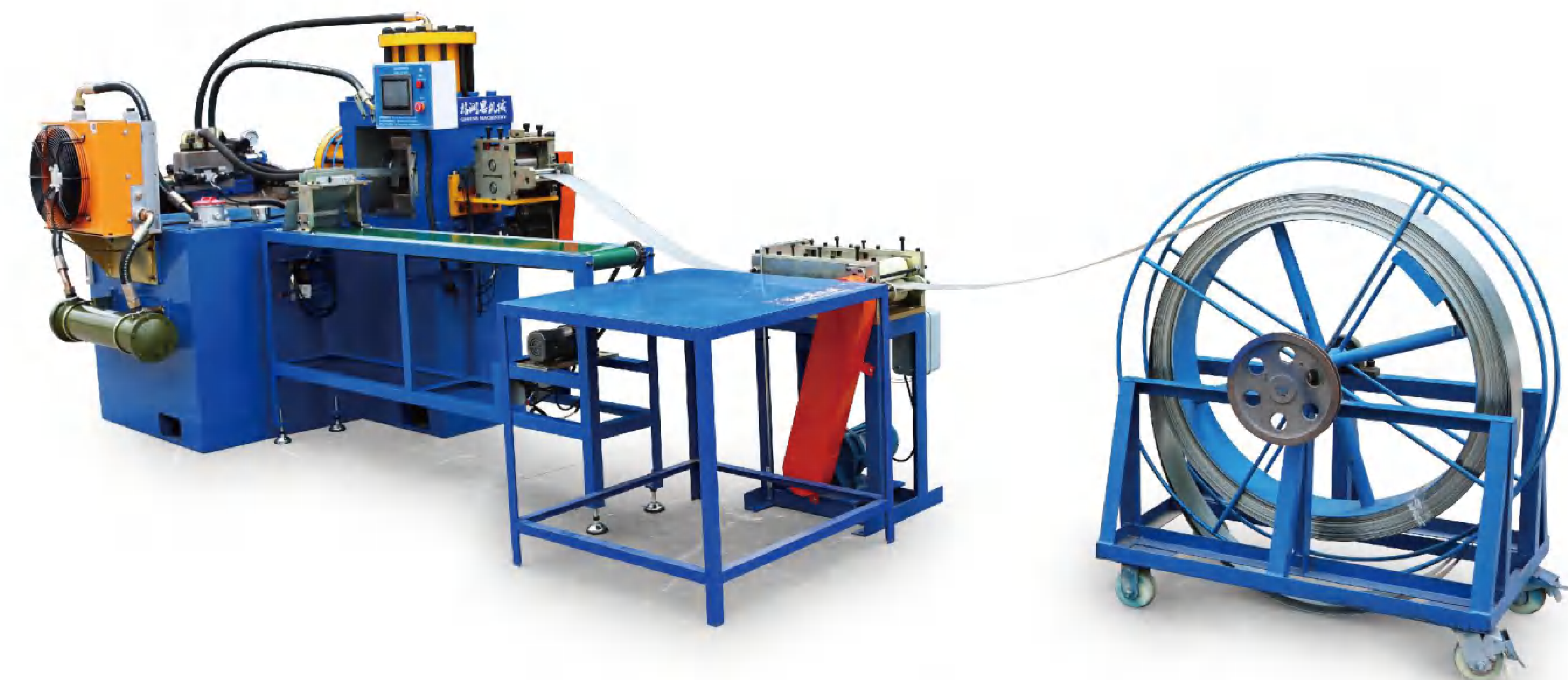

功能描述Function:

采用加大液压油罐设计，采用日本三菱PLC可编程控制器，加厚主体机身墙板，采用台湾进口电磁换向阀，风、水冷却系统，伺服电机送料，触摸屏控制，专业生产F/T钉。

It uses thick hydraulic oil tank and Japan Mitsubishi PLC Programmable controller. Thicken machine wall plate. Adopts Taiwan Solenoid directional valve. It is specialized for producing F/T staple.

F新型液压直排钉成型机

功率Motor power	5.5KW
速度Speed	100-150 pcs/min
重量Weight	1100KG
外形尺寸Dimension	1700*1700*1500mm

F/T新型液压直排钉成型机、斜排钉成型机

功率Motor power	5.5+2.3KW
速度Speed	100-140 pcs/min
重量Weight	1200KG
外形尺寸Dimension	1700*1700*1500mm



本机摒弃了传统的重型冲床，采用液压系统为执行部件，利用PLC微电脑集中控制，具有操作安全、性能稳定、噪音小等特点，比传统的冲床成型机打钉的速度大幅度提高。

This machine abandoned the traditional heavy punch, using oil pressure system as the executive parts, using PLC microcomputer centralized control, with safe operation, stable performance, low noise and other characteristics, compared with the traditional punch forming machine nail-punching speed greatly improved.

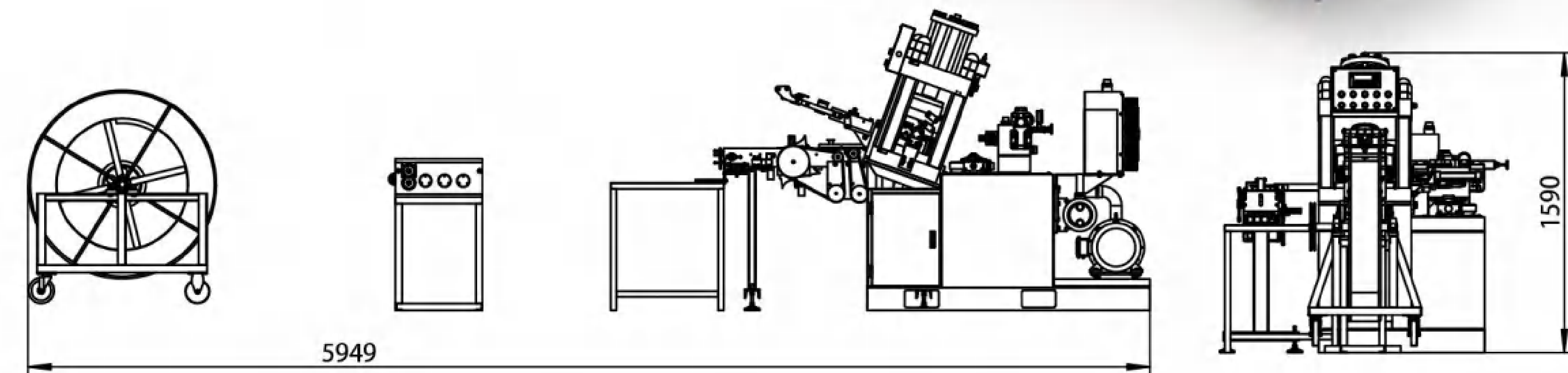
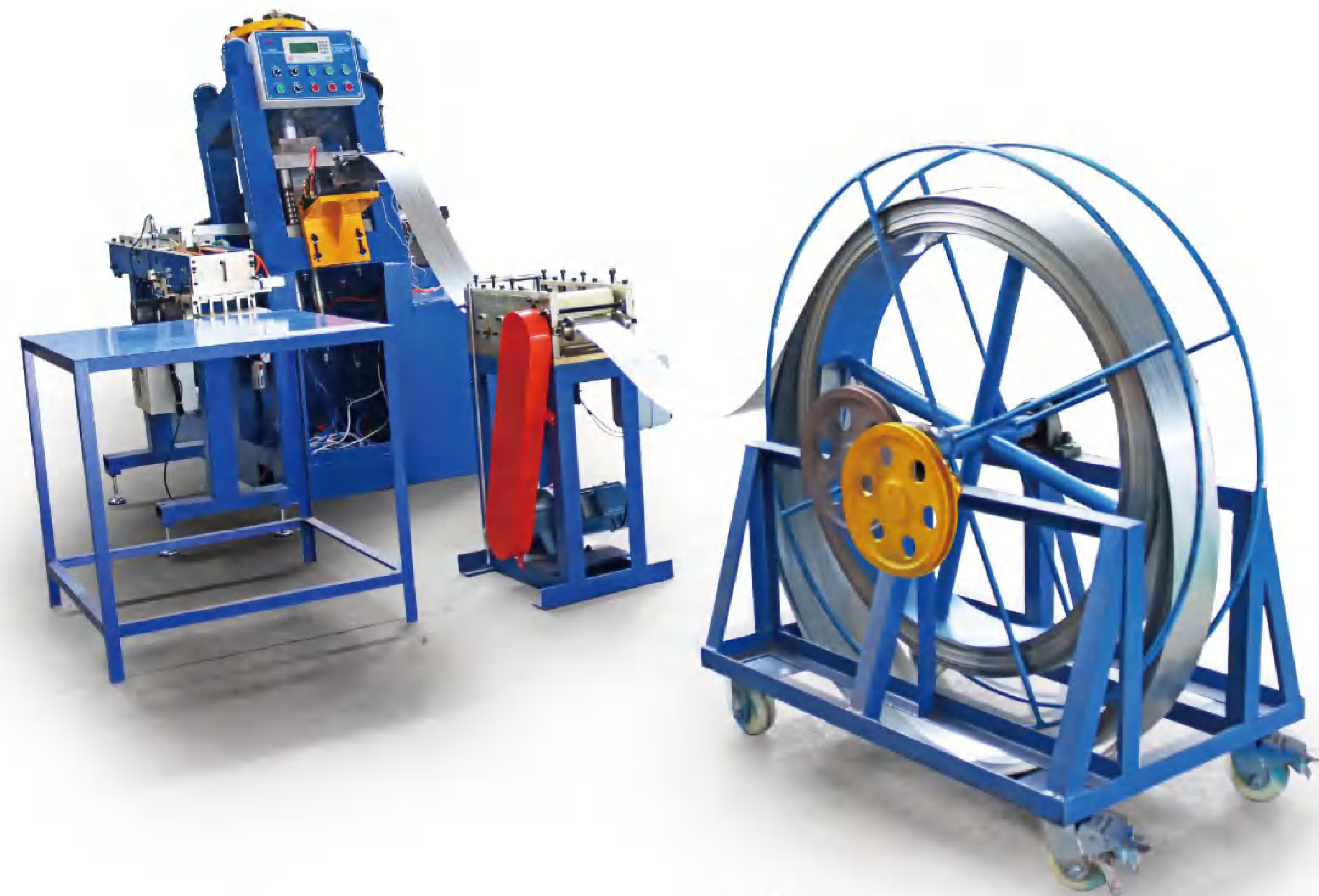

N、K型成型机N、K type forming machine

功率Motor power	5.5KW
速度Speed	80-110 pcs/min
重量Weight	1800KG
外形尺寸Dimension	1700*1700*1500mm

J型成型机J type forming machine

功率Motor power	5.5KW
速度Speed	80-130 pcs/min
重量Weight	1500KG
外形尺寸Dimension	1700*1700*1500mm

Office Staple Pin Forming And Packing Machine

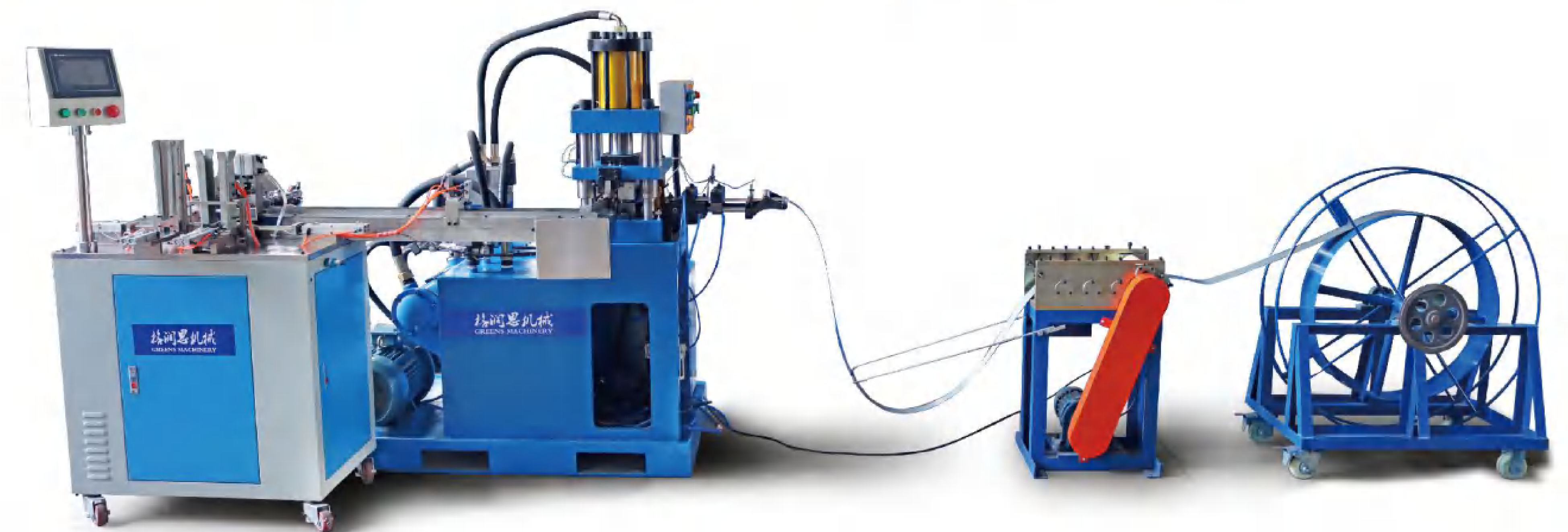
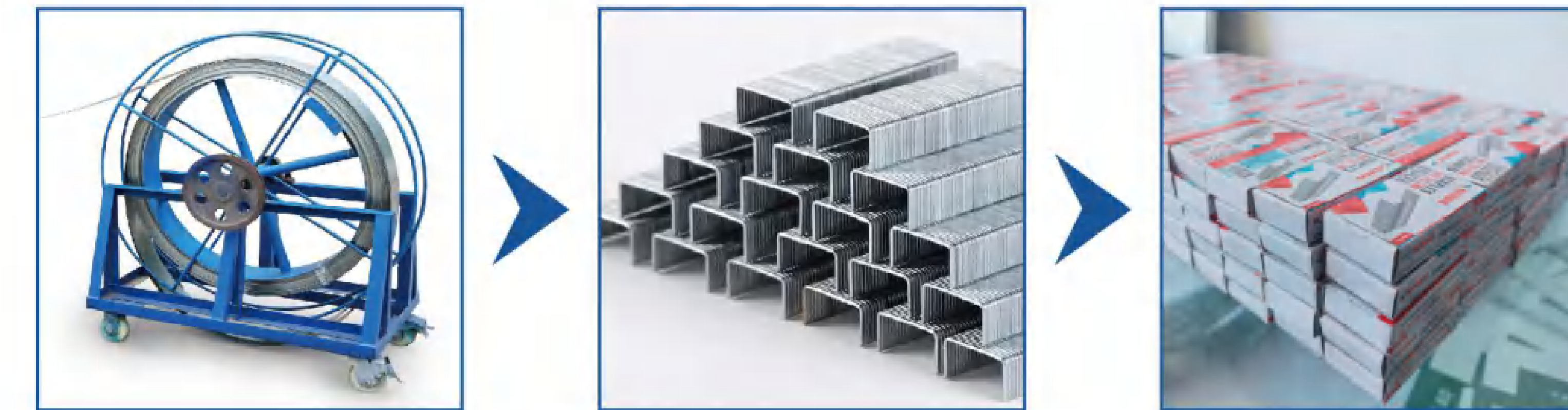

功能描述Function:

该机适用于生产24/6、26/6、10号订书钉，摒弃了传统的重型冲床，采用液压系统作为执行部分，采用PLC微电脑集中控制。具有运行安全、性能稳定、噪音低等特点。

This machine Suitable for producing 24/6, 26/6, No.10 staple pins, abandons traditional heavy-duty punches, uses hydraulic system as the execution part, and uses PLC microcomputer centralized control. It has the characteristics of safe operation, stable performance and low noise.

功率 Motor power	5.5 KW
产量 Capacity	12-18 pieces/min
包装速度 Packing speed	4-7 box/min
重量 Weight	1400 KG
外形尺寸 Dimension	1345*1170*1700 mm



ALEMINSAN MAKİNE
www.aleminsan.com.tr

Yafes ALEMİN
CEO

T: +90 216 394 31 32
G: +90 532 795 55 89
F: +90 216 394 34 28
Mescit Mah. İlim Sk. No: 1 Orhanlı
Tuzla / İstanbul / Türkiye



产品类型: 干壁钉 (磷化干壁螺钉/蓝白锌干壁螺钉)
材质: 钢材
产品规格: M3.5*16, M3.5*20, M3.5*25, M3.5*30, M3.5*35, M3.5*40, M3.5*50
长度: 35, 40, 50, 20, 30, 25, 16 (mm)
产品工艺: 标准十字槽
特点: 硬度高, 不生锈
产品用途: 主要运用各种石膏板、轻质隔墙和天花板吊顶系列的安装。

Product Type: Dry wall nail (Phosphating dry wall screws/blue and white zinc dry wall screws)
Material: steel
Product Specifications: M3.5*16, M3.5*20, M3.5*25, M3.5*30, M3.5*35, M3.5*40, M3.5*50
Length: 35, 40, 50, 20, 30, 25, 16 (mm).....
Product technology: standard cross
Features: High hardness, no rust
Product usage: mainly use all kinds of plasterboard, light partition wall and ceiling ceiling series installation.



产品类型: 家具螺丝钉
材质: 不锈钢
产品规格: 各种规格
长度: 实际定制
特点: 硬度高, 不易生锈、耐腐蚀。
产品用途: 机械工业用紧固件, 汽车零部件、电力产业、太阳能产业、船用紧固件、桥梁工程、家具、电子、电器行业用紧固件, 建筑装修用紧固件, 铁路行业等。

Product type: Furniture screws
Material: stainless steel
Product specifications: various specifications
Length: actual customization
Features: high hardness, not easy to rust, corrosion resistance.
Application: Fasteners for machinery industry, auto parts, electric power industry, solar energy industry, Marine fasteners, bridge engineering, furniture, electronics, electrical appliances industry, construction and decoration fasteners, railway industry, etc.



产品类型: 钻尾螺丝钉
材质: 钢
产品规格: 各种规格
长度: 实际定制
槽型: 外六角
作用方式: 钻尾
特点: 较高硬度和韧性, 耐腐蚀性较好, 热强性和冷变型性能减速震性很好。
产品用途: 适用各种钢板、槽钢、彩钢瓦等。

Product type: Drill end screw
Material quality: steel
Product specifications: various specifications
Length: actual customization
Bad type: outer hexagon
Mode of action: drill tail
Features: high hardness and toughness, good corrosion resistance, thermal strength and cold deformation performance deceleration shock is very good.
Application: suitable for all kinds of steel plate, channel steel, color steel tile, etc.



产品类型: 自攻螺丝钉
材质: 碳钢和不锈钢两种。
产品规格: 各种规格
长度: 实际定制
产品工艺: 标准十字槽
特点: 硬度高, 芯部韧性好。
产品用途: 用于薄的金属板(钢板、锯板等)之间的连接。

Product type: self tapping screw
Material: carbon steel and stainless steel.
Product specifications: various specifications
Length: actual customization
Product technology: standard cross
Features: high hardness, good toughness of the core.
Application: Used for connecting thin metal plate (steel plate, saw plate, etc.).



电脑维修及组装
Computer repair and assembly



门窗维修
Doors and Windows maintenance



吊顶、家用装修
Ceiling, home decoration



家用电器安装维修
Installation and maintenance of household appliances



组装车间
Assembly workshop



桥梁修建紧固
Bridge construction fastening



家具紧固
Furniture fastening



家具紧固
Furniture fastening



ALEMINSAN MAKİNE
www.aleminsan.com.tr

Yafes ALEMİN
CEO

T: +90 216 394 31 32
G: +90 532 795 55 89
F: +90 216 394 34 28
Mescit Mah. İlim Sk. No: 1 Orhanlı
Tuzla / İstanbul / Türkiye





YETKİLİ SATIŞ EKİBİMİZ BÜLENT ALEMİN YAFES ALEMİN MERT ALEMİN DOĞUKAN ALEMİN
钻尾螺丝切尾机 Drilling Tail Screw Cut Machine

功能描述 Function:

该一模二冲高速冷镦机是专业用于生产一般普通各类螺丝产品，此机速度快、精度高大大提高生产效率。
 This high speed heading machine is specialized in manufacturing common types screws.



型号 Model	HM-1030	HM-1563	HM-20102	HM-20120	HM-1576
最大可制外径 Max Diameter	Φ2-4mm	Φ3-5mm	Φ3-6mm	Φ3-6mm	Φ3-6mm
最大可制长度 Max Length rang	5-30	5-63	5-102	5-120	5-76
每分钟产量 Capacity	180-220	150-170	70-90	60-80	150-170
电机功率 Motor	1.5KW	2.2KW	5.5KW	5.5KW	3KW
油泵功率 Oil Pump	1/4KW	1/4KW	1/4KW	1/4KW	1/4KW
净重 Net Weight	1200KG	1700KG	3000KG	3500KG	1700KG
外形尺寸 Dimensions	1.7*1.7*1.5m	2.1*1.9*1.5m	2.8*2.1*1.5m	2.5*1.2*1.5m	2.2*1.9*1.5m

高速搓丝机 High Speed Thread Rolling Machine

功能描述 Function:

本设备是将螺丝及五金产品进行有序的排列下料搓丝，加工各种普通螺丝。
 This machine is to make thread of screws and hardware products, which is to produce different types of common screws.



型号 Model	CH4R	CH5R	CH6R	CH8R
搓牙直径 Thread Dia	2-4mm	4-6mm	4-8mm	4-8mm
搓丝长度 Thread Length	35	5-50	6-60	8-120
每分钟产量 Capacity	25-380	200-240	180-220	180-210
模具尺寸 Die Dimensions	76*89*40	90/105*25*60	100/115*25*80	108/127*25*120
主电机 Main Motor	2.2-6KW	4.0-4KW	5.5-4KW	7.5-4
油泵功率 Oil Pump	0.37KW	0.37KW	0.37KW	0.37KW
净重 Net Weight	1040KG	1000KG	2100KG	2300KG
装箱体积 Dimension	1.56*1.18*1.79m	1.35*1.7*1.5m	2.5*1.2*1.6m	2.7*1.4*1.7m

插片机 Insert machine

功能描述 Function:

- 1.利用油星方式，使螺丝与华司做快速组合。
- 2.利用旋转上升的方式，提高生产速度。
- 3.使用PLC控制做高速运转，精确检测出不良品（螺丝与华司未结合完成）。
- 4.操作箱面板，有异常检测LED显示，方便操作者做故障排除。



1. Bring the screws and washers into plate movement of both within the machine; it makes the assembly of screws with washers faster.
2. Use revolving and rising methods to enhance the production speed.
3. Use the PLC control to precisely examine irregular products (screws and washers combination has not completed).
4. The operating box has LED demonstration when a problem occurs, it is more convenient for the operator to trouble shoot.

生产速度 (单打) Production speed (singles)	120-520pcs/min
生产速度 (双打) Production speed (doubles)	60-150pcs/min
生产长度 Production length	9.5-125mm
磨具规格 Abrasive specifications	MB or MA
自动控制系统 Automatic control system	PLC Controller
机械重量 Machine weight	2000kg
外形尺寸 Dimensions	1.8m*1.4m*1.6m

主马达 Main Motor	5.5KW 6P 3PH (7.5HP)
电压 Voltage	Depends on the customer
变频器 Inverter	7.5KW (10HP)
生产速度 (单打) Producing Speed	120-520pcs/min (Single Stroke)
生产速度 (双打) Producing Speed	60-150pcs/min (Double Stroke)
生产规格 Wire Diameter	#6 (Φ2.8) - #12 (Φ4.3) No.1-No.3
震动送料机 Vibrator Feeder	Φ620mm+silent PU gelatin spraying
生产长度 Screw Length	9.5mm-125mm (3/8" -5")
模具规格 Die Holder	MB or MA (Depends on the customer)
自动控制系统 Auto-Action Controller	PLC Controller
机械重量 Machine WT	approx. 1994KG 2S+2KG
外形尺寸 Dimensions	1900mm×1400mm×1600mm



ALEMINSAN MAKİNE
www.aleminsan.com.tr

Yafes ALEMİN
CEO

ALEMİN SAN
SOĞUK TEL ÇEKME

ALEMİN SAN
KANEPE VE KOLTUK MEKANIZMA SİSTEMLERİ

ALEMİN SAN
SOĞUK ÇEKME LAMA

T: +90 216 394 31 32
 G: +90 532 795 55 89
 F: +90 216 394 34 28
 Mesit Mah. İlim Sk. No: 1 Orhanlı
 Tuzla / İstanbul / Türkiye

Widely used in aircraft, ships, automobiles, machinery, furniture, electrical appliances, solar energy, containers, luggage and other industries.

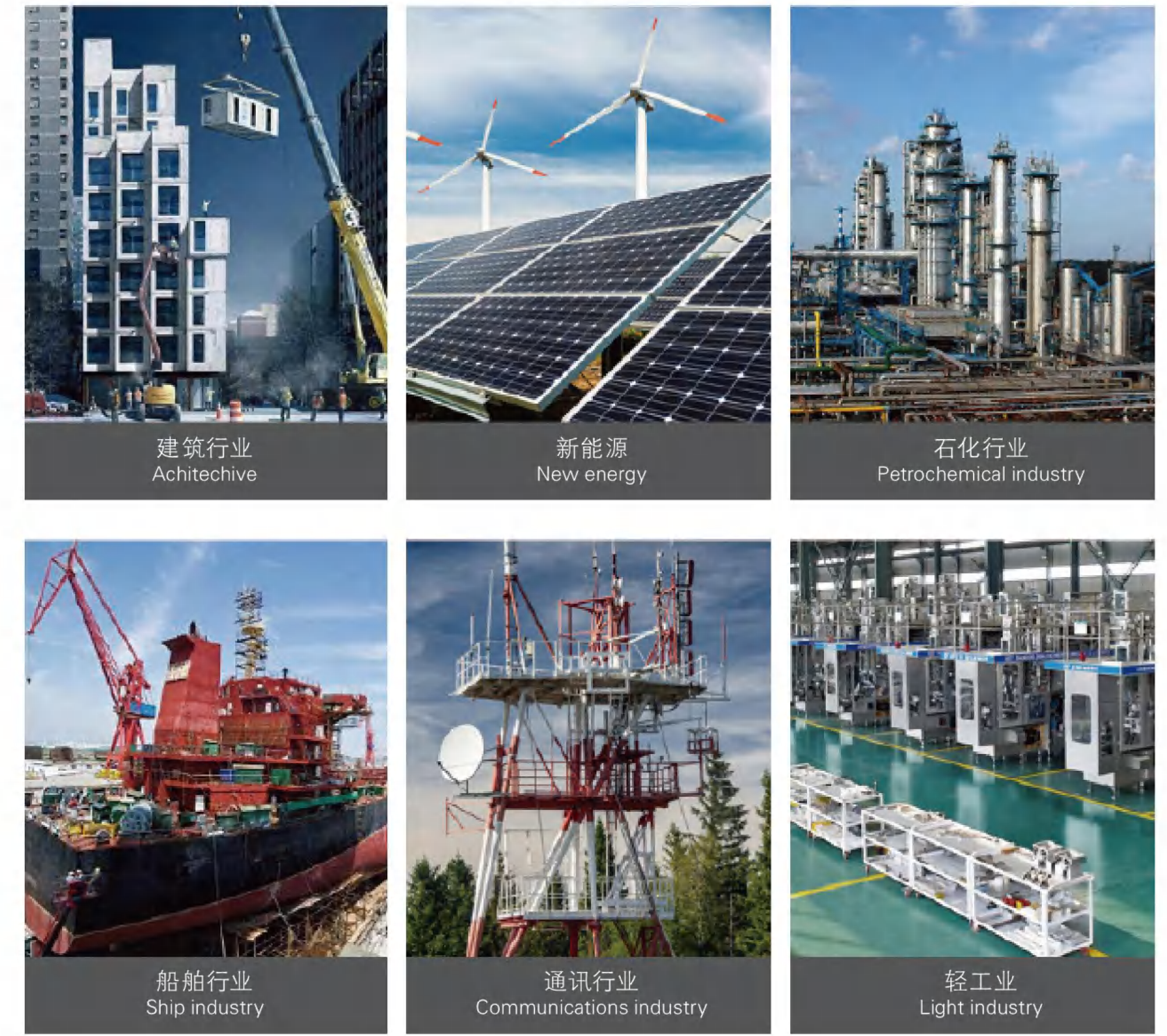



ALEMİNSAN MAKİNE
www.aleminsan.com.tr

Yafes ALEMİN
CEO

T: +90 216 394 31 32
G: +90 532 795 55 89
F: +90 216 394 34 28
Mesit Mah. İlim Sk. No: 1 Orhanlı
Tuzla / İstanbul / Türkiye

ALEMİN SAN
SOĞUK TEL ÇEKME

ALEMİN SAN
KANEPE VE KOLTUK MEKANİZMA SİSTEMLERİ

ALEMİN SAN
SOĞUK ÇEKME LAMA

YETKİLİ SATIŞ EKİBİMİZ BÜLENT ALEMİN YAFES ALEMİN MERT ALEMİN DOĞUKAN ALEMİN

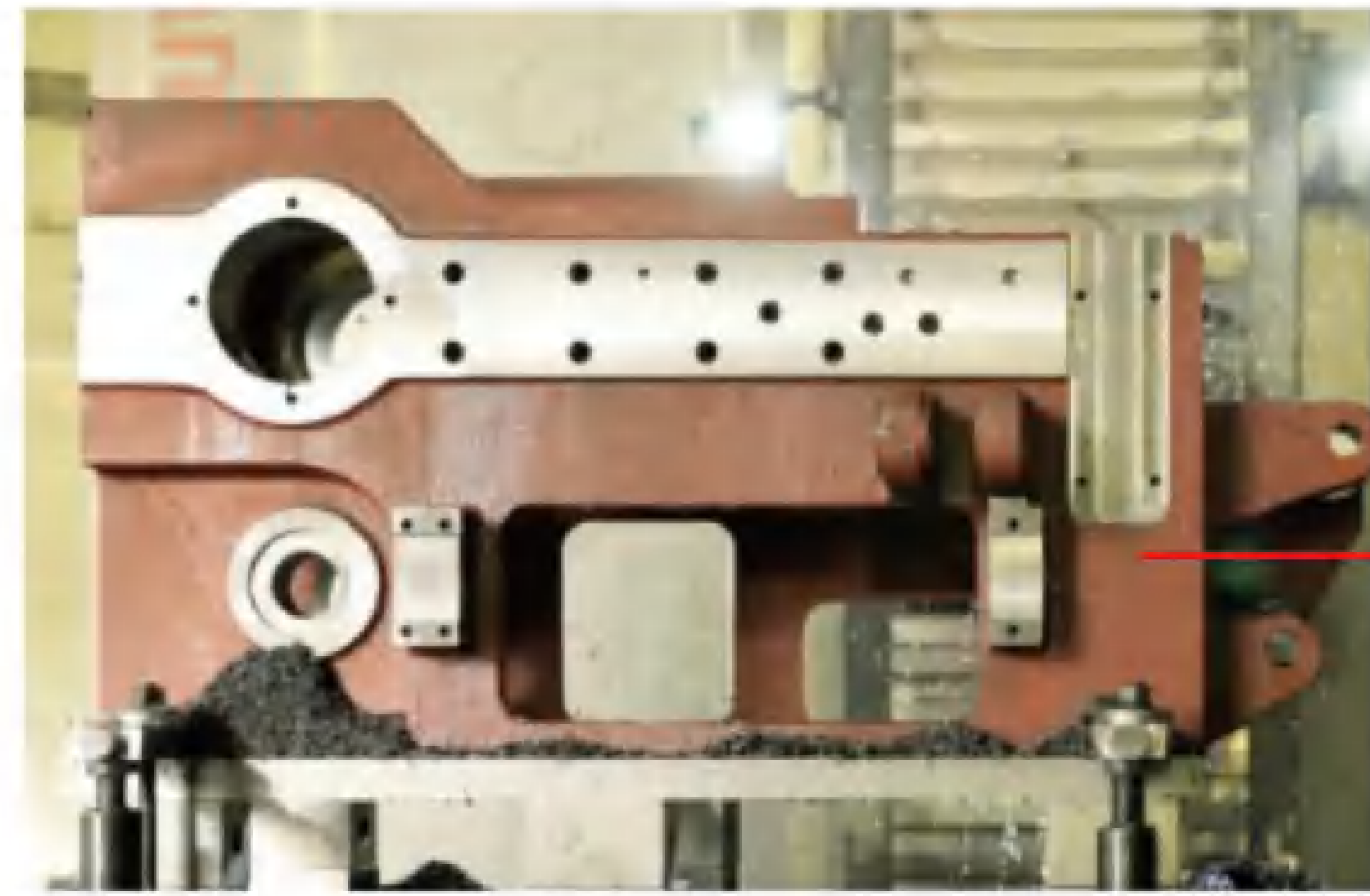

铸铁以抗拉强度极好的合金铸铁铸成，并经国家检验部门质量检测，具有极佳的吸震性能，在高速冲压及高速进给的情况下，机身沉稳，震动小，保证机台的长期精度。

Cast iron is made of alloy cast iron with excellent tensile strength, and has been inspected by the national inspection department. It has excellent shock absorption performance. In the case of high-speed stamping and high-speed feeding, the body is stable, and the vibration is small, which ensures the long-term accuracy of the machine.

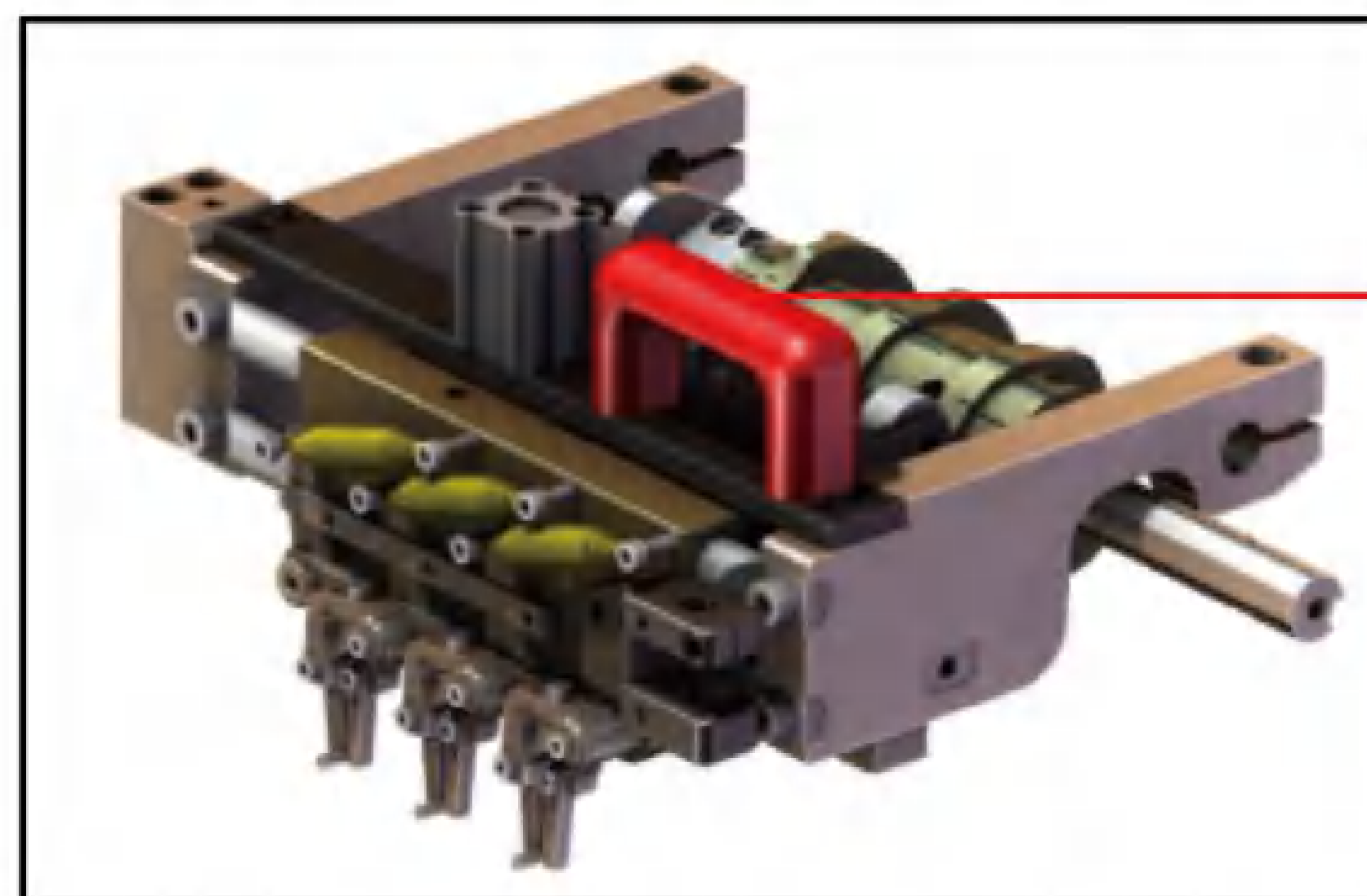

夹台：自主专利研发的模块化夹钳系统，高速精准，操作便利，易于维护。节省了操作的员调机时间，减少了新手学习时间

Clamp Sets: The modular clamp system developed by our own patent has the advantages of high speed and precision, convenient operation and easy maintenance. It can save the time for the operator to adjust the machine and reduce the learning time of the novice.



伺服电机特性：格润思高速精密多工位冷墩机新动力、新格局、新增长，创造更高生产效率与能源效益。

●主马达 采用伺服电机驱动控制，电路系统为伺服驱动器加PLC智能操作检测系统，(电压280V以上)对厂里电压与电网起到很好的保护，节能、降耗、省电，综合效益30%以上。

●正反寸动响应速度快，对模可以秒动，低高速输出转矩一样，扭力线性输出优越的控制产品精度，生产过程效率提高(无线变速)。

GREENS high speed precision multi position cold heading machine: new power, new pattern, new growth, creating higher production efficiency and energy efficiency.

●The main motor is driven and controlled by servo motor: the circuit system is servo driver and PLC intelligent operation detection system (voltage above 280v), which can protect the voltage and power grid of the plant, save energy, reduce consumption and save power more than 30%.

●The positive and negative inching response speed is fast, the mold can move in seconds, and the low and high speed output torque is the same. The torque linear output has superior control accuracy, and the production process efficiency is improved (stepless speed change).

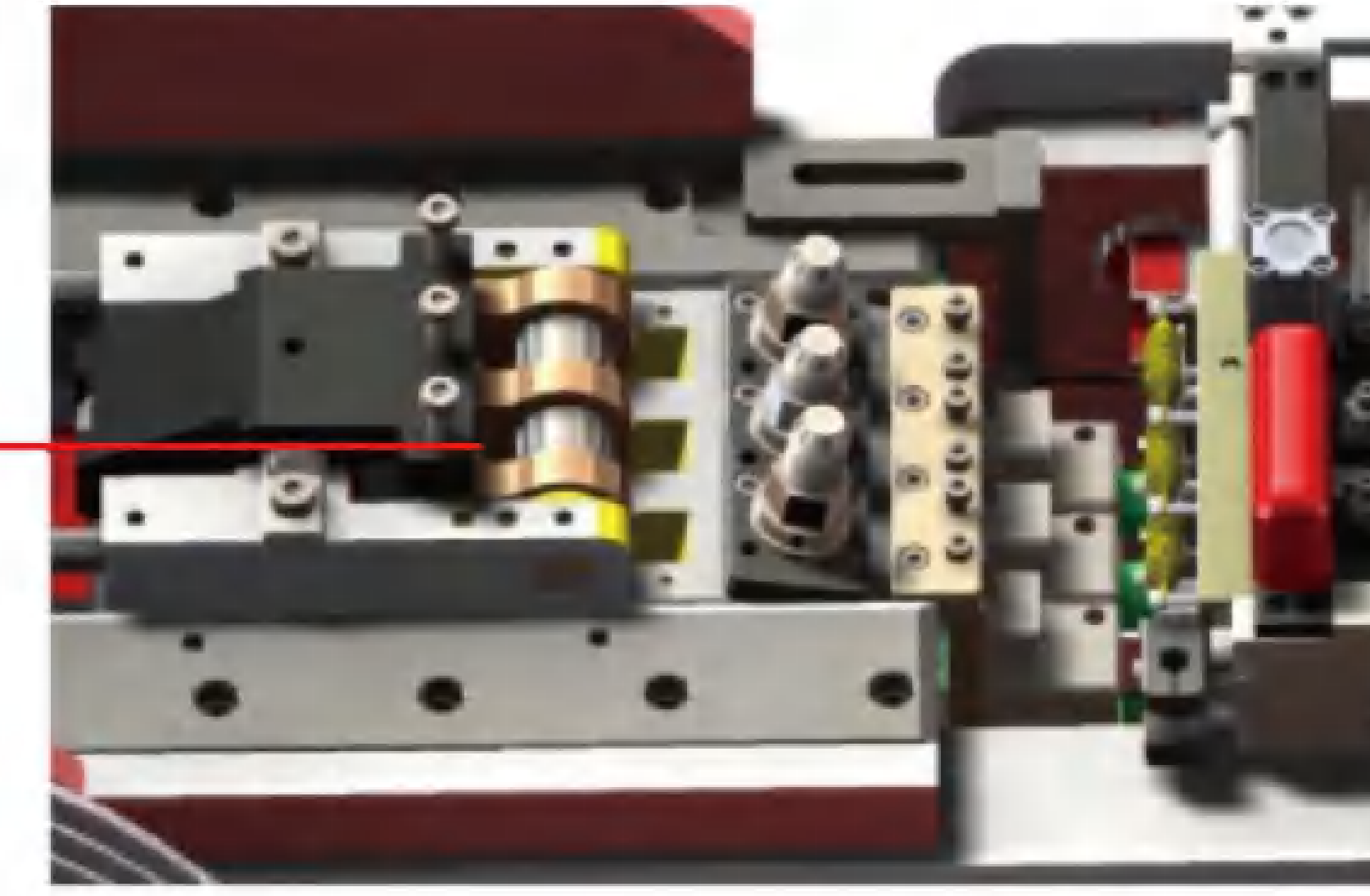
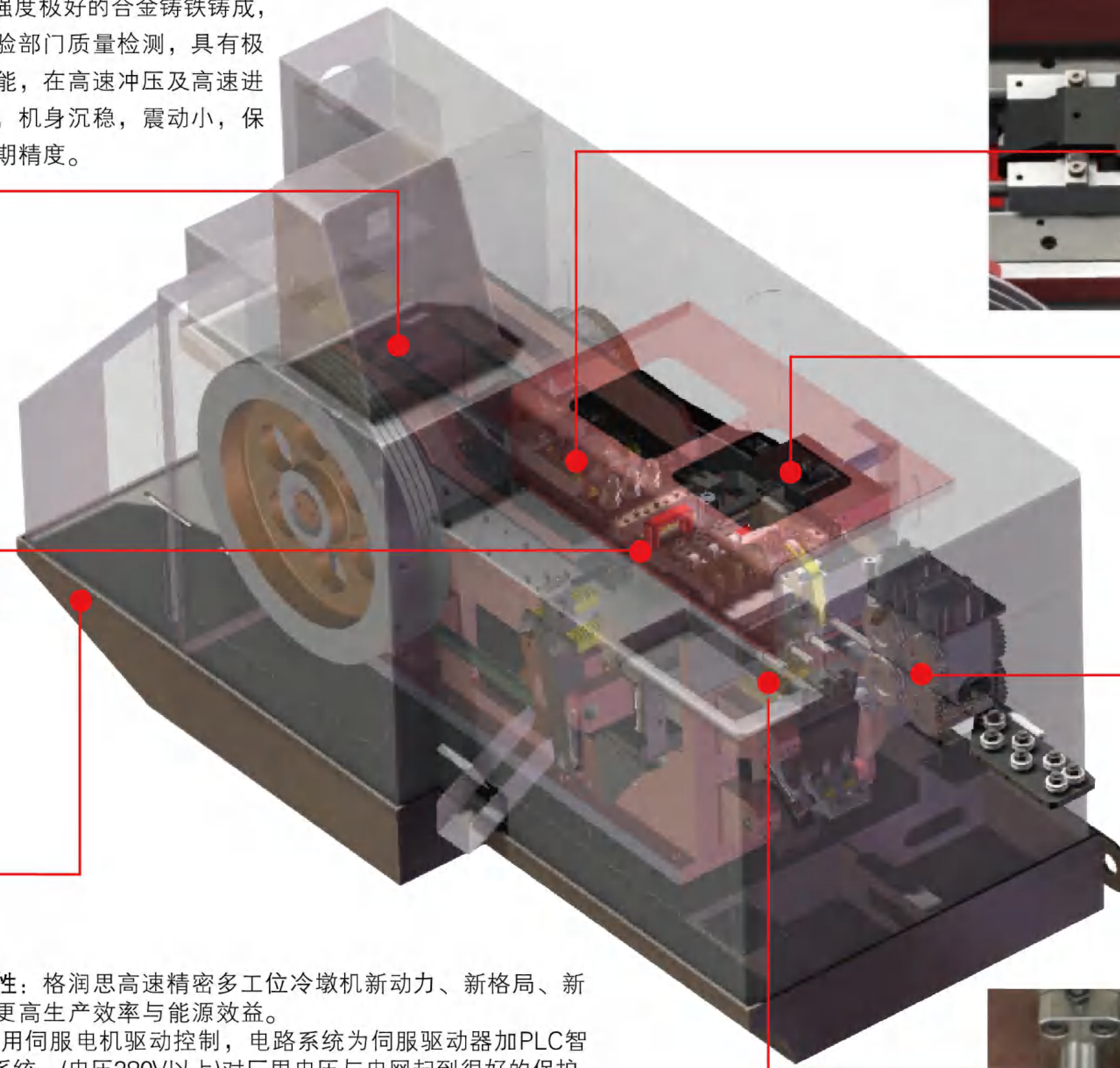

主滑台：加长一体式特殊铸件滑块，采用进口五轴加工一次加工成型，保证精度和长期耐磨。

Main Slide: Lengthening integral special casting slide block, using imported five axis processing, one-time processing to ensure accuracy and long-term wear resistance.



切料：自主专利研发的切料系统，可实现方便的切刀快速安装，优化的切料曲线，保证切料平整稳定。

Material Cut-off: The cutting system developed by our own patent can realize the quick installation of the cutter, optimize the cutting curve and ensure the smooth and stable cutting.

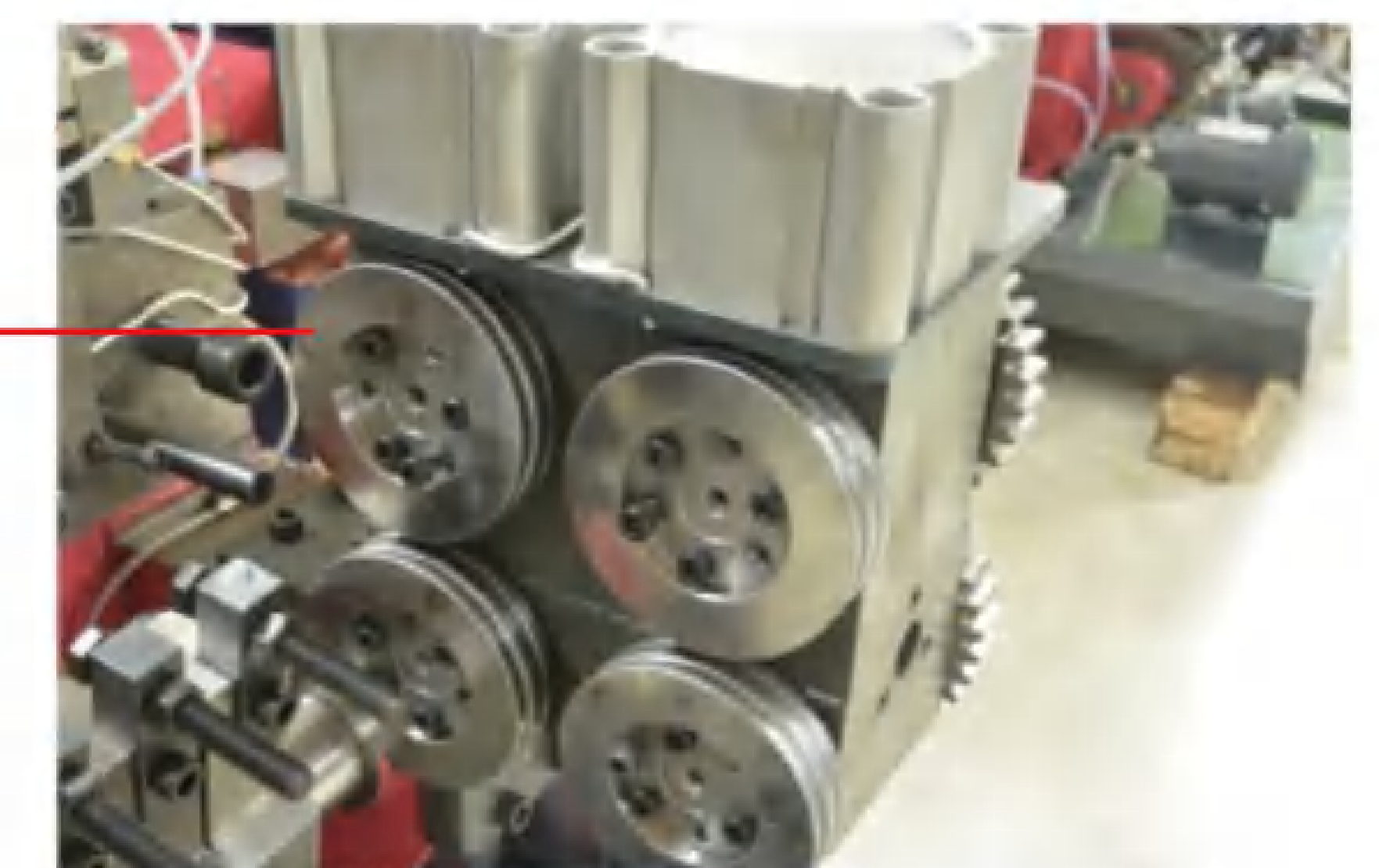

送料：采用气压可调压式双进料系统，高精度送料传动齿轮，保证送料长期精度和稳定。

Material Feeding: The double feeding system with adjustable air pressure and high-precision transmission gear ensures long-term accuracy and stability of feeding.

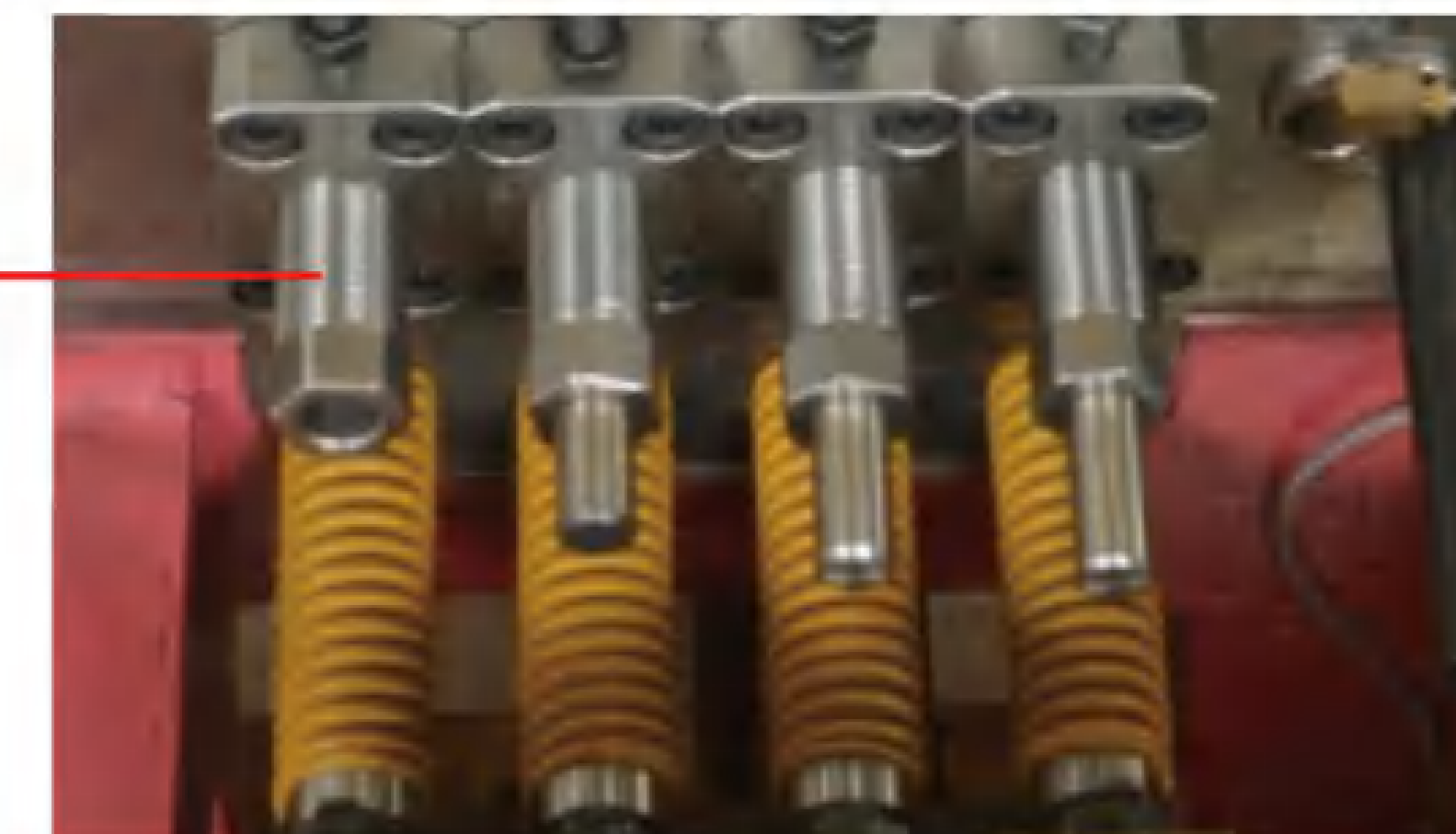

后通出：采用凸轮模块，可每工位单独调整行程，可实现稳定产品排出和切边等功能。

Back Pass-out: With cam module, the stroke can be adjusted individually for each station, and the functions of stable product launch and trimming can be realized.



ALEMİNSAN MAKİNE
www.aleminsan.com.tr

Yafes ALEMİN
CEO

T: +90 216 394 31 32
G: +90 532 795 55 89
F: +90 216 394 34 28
Mesic Mah. İlim Sk. No: 1 Orhanlı
Tuzla / İstanbul / Türkiye

ALEMİN SAN
SOĞUK TEL ÇEKME

ALEMİN SAN
KANEPE VE KOLTUK MEKANİZMA SİSTEMLERİ

ALEMİN SAN
SOĞUK ÇEKME LAMA

YETKİLİ SATIŞ EKİBİMİZ BÜLENT ALEMİN YAFES ALEMİN MERT ALEMİN DOĞUKAN ALEMİN

型号 Model	GRS-103L	GRS-133S	GRS-133L	GRS-163S	GRS-203L
工位数 No. Forging station	3	3	3	3	3
成型力 kgs Forging force	80.000	120.000	120.000	200.000	350.000
最大切断直径 mm Max cut-off dia	Φ 12	Φ 15	Φ 15	Φ 18	Φ 22
最大切断长度 mm Max cut-off length	195	145	250	200	240
生产速度 pcs/min Speed Range	85-160	90-160	60-110	70-120	50-80
动模顶出行程 mm P.K.O Stroke	15	30	30	40	50
定模顶出行程 mm K.O.Stroke	165	115	230	170	220
主滑台行程 mm Main slide stroke	280	200	350	260	346
主电机功率 kw Main motor	22	30	30	55	75
剪模外形尺寸 mm Cut-off-die size	Φ 45*59L	Φ 63*69L	Φ 55*70L	Φ 60*90L	Φ 75*120L
动模外形尺寸 mm Punch die size	Φ 53*112L	Φ 60*130L	Φ 60*179L	Φ 75*185L	Φ 90*215L
定模外形尺寸 mm Main die size	Φ 75*200L	Φ 86*135L	Φ 86*265L	Φ 100*190L	Φ 125*240L
模具间距 mm Die pitch	90	98	110	120	140
机器外形尺寸 mm Machine dimension(L*W*H)	570*250*230	460*260*200	780*260*270	650*290*250	760*300*300
机器重量 Ton Machine weight (Approx)	19.5	19.5	31	36	55
可制螺丝直径 mm Normal bolt size	6-10	8-13	8-13	10-18	12-22
可制螺丝头下长度mm Shank length of blank	25-160	20-110	70-210	20-160	25-210

型号 Model	SJBF-164S	SJBF-164LL	SJBF-164UL	SJBF-204L	SJBF-204LL	SJBF-254SL	SJBF-254LL	SJBF-384L
工位数 No. Forging station	4	4	4	4	4	4	4	4
成型力 kgs Forging force	220.000	220.000	230.000	380.000	380.000	450.000	450.000	800.000
最大切断直径 mm Max cut-off dia	Φ 18	Φ 18	Φ 23	Φ 22	Φ 22	Φ 28	Φ 28	Φ 42
最大切断长度 mm Max cut-off length	200	350	510	240	360	260	380	450
生产速度 pcs/min Speed Range	70-110	40-70	35-50	50-90	40-65	40-80	35-60	30-50
动模顶出行程 mm P.K.O Stroke	45	45	60	50	50	40	45	60
定模顶出行程 mm K.O.Stroke	170	320	510	220	320	210	315	380
主滑台行程 mm Main slide stroke	260	490	670	346	496	330	510	570
主电机功率 kw Main motor	55	55	75	75	75	110	110	200
剪模外形尺寸 mm Cut-off-die size	Φ 60*90L	Φ 64*100L	Φ 74*120L	Φ 75*120L	Φ 75*120L	Φ 80*130L	Φ 99*150L	Φ 120*150L
动模外形尺寸 mm Punch die size	Φ 75*185L	Φ 75*185L	Φ 75*250L	Φ 90*215L	Φ 90*215L	Φ 120*270L	Φ 120*270L	Φ 145*320L
定模外形尺寸 mm Main die size	Φ 100*190L	Φ 100*345L	Φ 100*510L	Φ 125*240L	Φ 125*345L	Φ 140*250L	Φ 148*345L	Φ 190*450L
模具间距 mm Die pitch	120	120	120	140	140	160	160	216
机器外形尺寸 mm Machine dimension(L*W*H)	650*310*260	870*320*300	1000*320*300	760*320*300	870*320*320	830*430*330	980*420*350	1100*520*400
机器重量 Ton Machine weight (Approx)	43	60	80	62	76	105	125	260
可制螺丝直径 mm Normal bolt size	10-16	10-16	12-20	12-20	12-20	14-27	14-27	20-40
可制螺丝头下长度mm Shank length of blank	20-160	70-310	150-490	25-210	70-310	35-210	70-310	70-370



ALEMİNSAN MAKİNE
www.aleminsan.com.tr

Yafes ALEMİN
CEO

T: +90 216 394 31 32
G: +90 532 795 55 89
F: +90 216 394 34 28
Mesit Mah. İlim Sk. No: 1 Orhanlı
Tuzla / İstanbul / Türkiye

ALEMİN SAN
SOĞUK TEL ÇEKME

ALEMİN SAN
KANEPE VE KOLTUK MEKANİZMA SİSTEMLERİ

ALEMİN SAN
SOĞUK ÇEKME LAMA

YETKİLİ SATIŞ EKİBİMİZ BÜLENT ALEMİN YAFES ALEMİN MERT ALEMİN DOĞUKAN ALEMİN

螺母冷镦机
Nut cold heading machine



模数	6
最大切断直径 (MAX) mm	24
最大切断长度 (MAX) mm	60
后托定出长度mm	130
母模中心距离mm	100
造压力(TON)	270
每分钟最大产能(PCS/MIN)	90
主马达(4/8POLE)kw	60
油泵马达kw	1.5
油用量 (GALLON)	380
机械重量 (TON)	25
机械尺寸 (L*W*H) m	5.3*2.56*1.95

螺母攻丝机
Nut Thread Rolling Machine



机型 Mode	转/分钟 Revolution per minute	只数/分钟 Number/ min	功率 Power
气压双轴攻牙机 (M3-M5) Pneumatic double tapping machine (M3-M5)	2000	90-80	0.55/2/2
	1800	80-75	0.75/4/2
	1700	75-70	
气压双轴攻牙机 (M6-M8) Pneumatic double tapping machine (M6-M8)	1400	60-55	1.1/4/2
	1200	50-45	
气压双轴攻牙机 (M22-M24) Pneumatic double tapping machine (M22-M24)	300	10-8	3/8/2带链条
	280	9-7	
气压双轴攻牙机 (M27-M33) Pneumatic double tapping machine (M27-M33)	255	8-6.5	4/4/2变频器, 变频电机, 减速器
	240	7.5-6	
	225		
气压双轴攻牙机 (M36-M42) Pneumatic double tapping machine (M36-M42)	210	6.5-5.5	4/4/2变频器, 变频电机, 减速器
	180	5.5-4.5	
	195		
气压双轴攻牙机 (M45-M48) Pneumatic double tapping machine (M45-M48)	165	4.5-4	5/6/2变频器, 变频电机, 减速器
	150	4-3.5	

Mesh belt furnace



型号规格 Model	Rcm-200-9	Rcm-45-9
功率 Motor power	200	45
装载量 Capacity (KG/hour)	200-250	60
工作尺寸 Working size (mm)	2100*400	2100*220
净重 Net Weight (kg)	18000	10000
工作温度 Working temperature (°C)	Quenching furnace	820~850
	Quenching tank	40~80
	Cleaning machine	20~80
	Annealing stove	≤600



ALEMINSAN MAKİNE
www.aleminsan.com.tr

Yafes ALEMİN
CEO

T: +90 216 394 31 32
G: +90 532 795 55 89
F: +90 216 394 34 28
Mesci Mah. İlim Sk. No: 1 Orhanlı
Tuzla / İstanbul / Türkiye



YETKİLİ SATIŞ EKİBİMİZ BÜLENT ALEMİN YAFES ALEMİN MERT ALEMİN DOĞUKAN ALEMİN

Point slotting machine



型号规格 Model	RG-30-9		RG-45-9	
	RG-60-9		RG-120-9	
功率 Power (kw)	30	45	60	120
装载量 Capacity (kg)	60	100	120	200
工作尺寸 Working size (mm)	φ 300×620		φ 520×680	
	φ 600×750		φ 750×1000	
加热功率 Heat power (kw)	30	45	60	120
工作温度 Working temperature (°C)	950			

井式电阻退火炉

Well type resistance annealing furnace

功能描述 Function:

井式电阻炉系周期作业式电炉，供钢铁零件淬火、回火、退火用，特别适用于铁丝再结晶退火，节能型电炉优点为炉衬采用刺纤维毯预制件组成，吸热系数小，电热元件悬挂在炉膛内，充分裸露直接辐射，热效率高，比传统电炉节能30%以上。

This kind of furnace work periodically, and it is suitable for quenching, tempering, annealing of the steel parts, especially used for iron wire recrystallization annealing. The advantages of an energy-saving resistance furnace lie in that the furnace lining is made of tufted fiber blanket, so it is of small heat absorption. And the thermoelectric components are hung in the hearth, which is fully exposed and directly irradiated, therefore its heat efficiency is high, and can save more than 30% of the energy than the traditional furnace.



额定功率 Rated power (kw)	18-480
最高工作温度 Max working temperature (°C)	900
最大直径 Max Diameter (mm)	3500

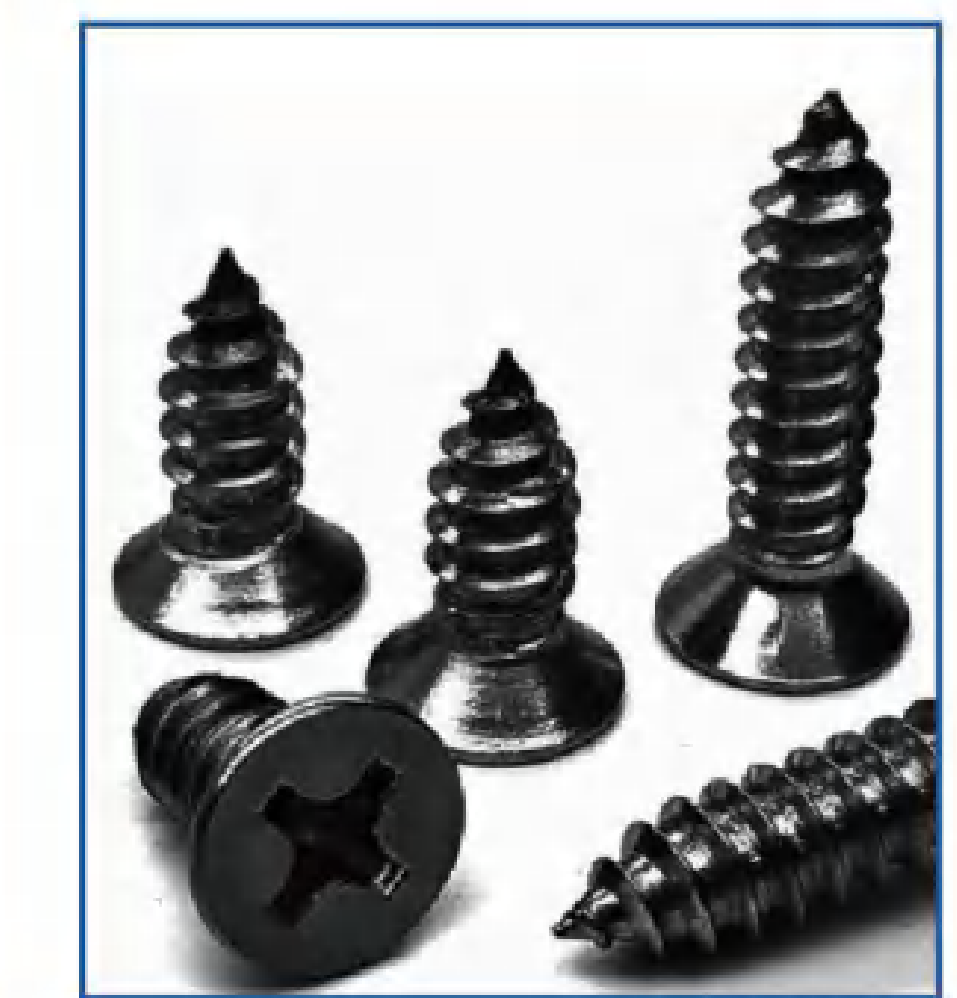

切刀电机 Cutter motor	0.37KW,6P,3PH(1/2HP)
分割减速电机 Split reducer motor	0.37KW,4P,3PH(1/2HP 1:3)
变频器 Inverter	Cutter motor 0.75kw(1HP)
变频器 Inverter	Split 0.75kw (1HP)
切削液电机 Cutting fluid motor	0.1kw,3PH(1/8HP)
自动控制系统 Auto-Action cotroller	PLC Controller
震动送料机 Vibrator feeder	φ 750+silent PU gelatin spraying
电压 Voltage	Assignde by client
自攻钉 Self-Tapping screw	ST3.5-ST6.3(TYPE:17&25)
机器螺丝 Machine screw	M3-M6(TYPE:23)
螺丝长度 Screw length	15m/m-150m/m
生产速度 Production speed	approx.50-325pcs/min
机器重量 Machine weight	approx.960kg



ALEMINSAN MAKİNE
www.aleminsan.com.tr

Yafes ALEMİN
CEO

T: +90 216 394 31 32
G: +90 532 795 55 89
F: +90 216 394 34 28
Mesat Mah. İlim Sk. No: 1 Orhanlı
Tuzla / İstanbul / Türkiye

ALEMİN SAN
SOĞUK TEL ÇEKME

ALEMİN SAN
KANEPE VE KOLTUK MEKANIZMA SİSTEMLERİ

ALEMİN SAN
SOĞUK ÇEKME LAMA

YETKİLİ SATIŞ EKİBİMİZ BÜLENT ALEMİN YAFES ALEMİN MERT ALEMİN DOĞUKAN ALEMİN

普通刺绳网机一般是指CS-A型双股刺绳机，双股刺绳机由绕丝和收丝加捻二部分连接组成，并配套四只放丝盘，该机主要适用于生产各种多股刺绳网，其使用材料应符合稳，操作灵活可靠，是国内目前唯一生产刺绳网的设备。

Ordinary barbed wire machine generally refers to CS-A double-strand barbed wire machine. The double-strand barbed wire machine is composed of two parts: winding wire and wire winding and twisting, and is equipped with four wire feeding reels. This machine is mainly suitable for To produce various multi-strand barbed wire nets, the materials used should be stable and the operation is flexible and reliable. It is the only equipment for producing barbed wire nets in China.

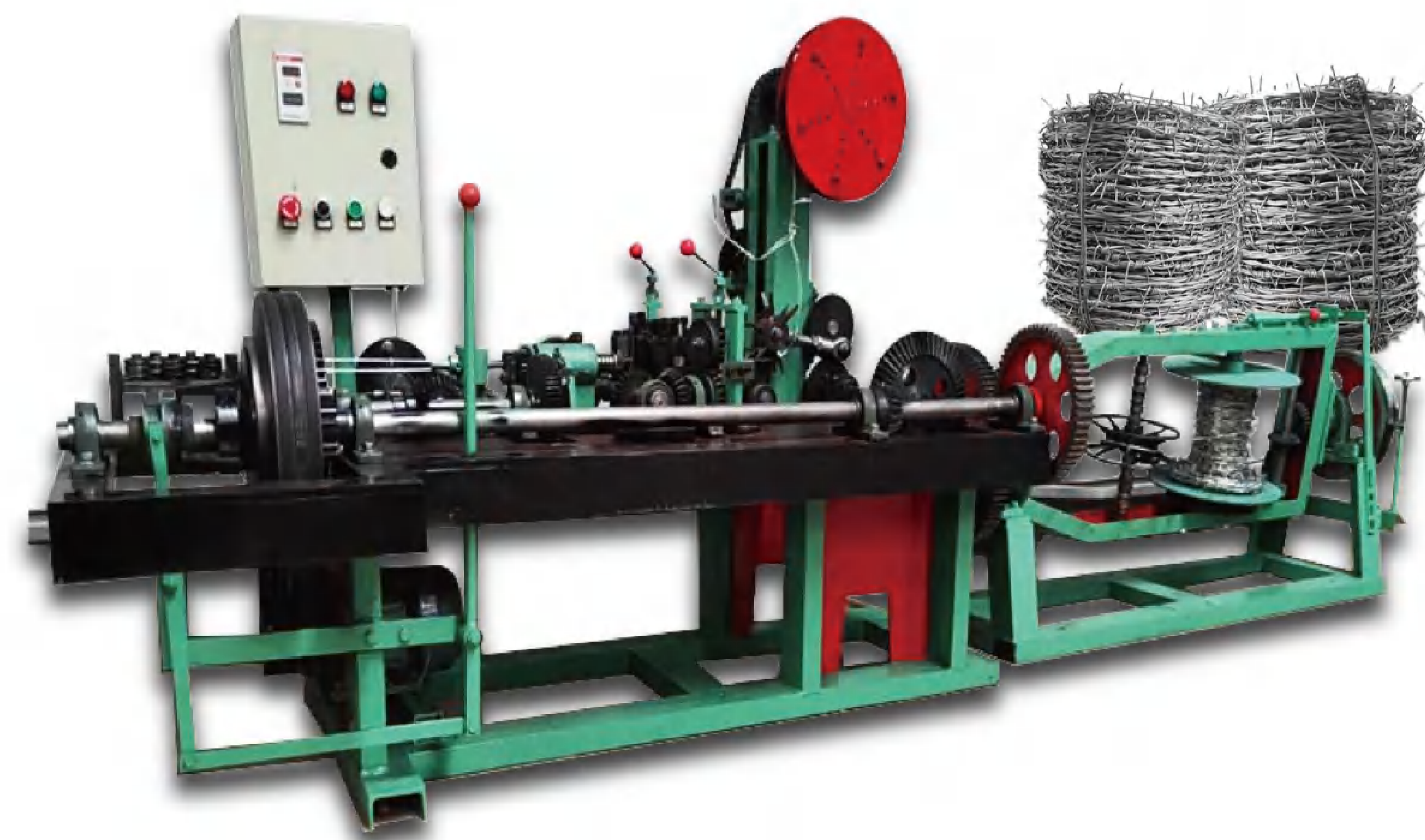

主丝直径 Main wire diameter (mm)	2.0-3.0			
刺丝直径 Barbed wire diameter (mm)	1.8-2.4			
铁丝抗拉力 Wire Tensile Strength (N/mm ²)	400-600			
刺间距 Thorn spacing (inch)	3' (7.5cm)	4' (10cm)	5' (12.5cm)	6' (15cm)3
电机功率 Motor power (kw)	440			
电压 Voltage (V)	Main :2000*1200*1400			
外形尺寸 Dimensions (mm)	Auxiliary:2000*650*800			
重量 Weight (kg)	1000			

LV-420B bag packing machine

本机振动储料斗通过振动的方式下料至磁力提升机，磁力提升机输送物料至称盒称重，称盒称重所需重量的约95%左右，剩下的通过振动盘计数补料的方式来达到客户总的需求量。

The vibrating storage hopper of this machine unloads the material to the magnetic hoist by vibration, and the magnetic hoist transports the material to the weighing box for weighing. way to meet the total demand of customers.



机型 Model	LV-420B装袋包装机 LV-420B bag packing machine
电源规格 Power Specifications	单相电 220V Single-phase electricity 220V
包装材料 Packaging Materials	复合膜(PET/PE, OPP/CPP) Composite film (PET/PE, OPP/CPP)
制袋尺寸 Bag size	最小 50mm(W)*50mm(L)/最大 200mm(W)*300mm(L) Min 50mm(W)*50mm(L)/Max 200mm(W)*300mm(L)
计量范围 Measurement range	1个-5kg,且在最大制袋范围内 1-5kg, and within the maximum bag making range
计量方式 Measurement method	称重+计数 Weighing + counting
适用产品 Applicable Products	螺丝, 螺母, 垫片, 铁钉等铁质五金(根据客户不同物料及规格来确定振动盘的数量) Screws, nuts, washers, iron nails and other iron hardware (according to the customer's different materials and specifications to determine the number of vibrating discs)
选配 Optional	打印机(可打印即时的时间, 字母, 数字, 二维码, 条形码, 简单的logo等) printer(Can print instant time, letters, numbers, QR codes, barcodes, simple logos, etc.)



ALEMİNSAN MAKİNE
www.aleminsan.com.tr

Yafes ALEMİN
CEO

T: +90 216 394 31 32
G: +90 532 795 55 89
F: +90 216 394 34 28
Mesat Mah. İlim Sk. No: 1 Orhanlı
Tuzla / İstanbul / Türkiye



YETKİLİ SATIŞ EKİBİMİZ BÜLENT ALEMİN YAFES ALEMİN MERT ALEMİN DOĞUKAN ALEMİN

应用范围 Range of application



产品类型: 圆钉
材质: 低碳钢Q195
产品规格: 20/25/30/40/50/60/70/80/100/130/150 (mm)
特点: 采用优质的钢材制作, 具有很好的耐腐蚀性, 由于它的表面镀了锌, 大大的增加了它的使用寿命。
产品用途: 适用于软硬木材、普通塑料、修制家具、土墙翻砂以及家庭装饰中壁画悬挂等。

Product type: Round nails
Material: Low carbon steel Q195
Product specifications: 20/25/30/40/50/60/70/80/100/130/150 (mm)
Point: made of high quality steel, with good corrosion resistance, due to its surface plated with zinc, greatly increased its service life.
Application: suitable for soft and hard wood, ordinary plastics, furniture repair, earth wall sand foundry and fresco hanging in home decoration, etc.

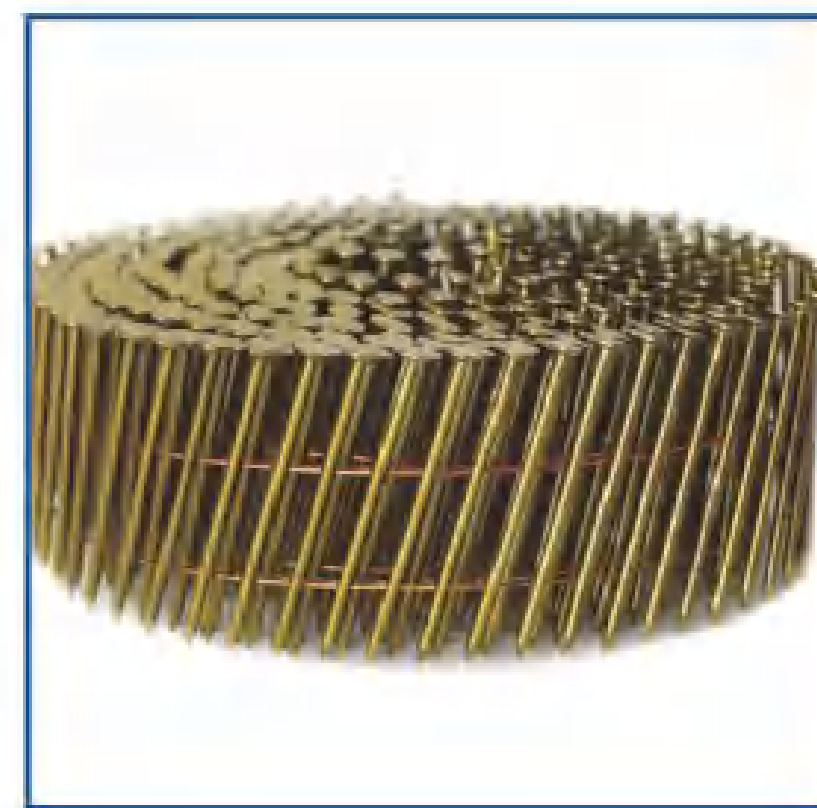

产品类型: 卷钉
材质: Q195/235
产品规格: 21X25(14000根), 21X28(14000根), 21X32(14000根)
特点: 具有高硬度, 抗拉强度高、耐腐蚀性强等特点。
产品用途: 卷钉广泛应用于木箱包装重负荷包装、木托盘、木制家具、木结构房屋高强度地板等。

Product type: Coil nails
Material: Q195/235
Product specifications: 21X25(14000)pcs, 21X28(14000)pcs, 21X32(14000)pcs
Point: High hardness, high tensile strength, strong corrosion resistance and so on.
Application: Coil nails are widely used in heavy load packing of wooden cases, wooden pallets, wooden furniture, wooden structure building high strength floor board, etc.



产品类型: 螺纹钉
材质: Q195
产品规格: 1.5寸 2寸 2.5寸 3寸 3.5寸 4寸
长度: 3~300 (mm)
特点: 入木锋利、不易弯曲、钉帽圆整有强度等优点。
产品用途: 用于建筑、装饰、装潢、装修业等固定物体

Product type: Threaded nails
Material: stainless steel
Product specification: 1.5 inch 2 inch 2.5 inch 3 inch 3.5 inch 4 inch
Length: 3~300 (mm)
Point: the wood is sharp, not easy to bend, the nail cap round strength and other advantages.
Application: used for building, decoration, decoration, decoration industry and other fixed objects.



产品类型: 水泥钉 (钢钉)
材质: 45号钢或60号钢
特点: 硬度很大, 粗而短, 穿凿能力很强。
产品用途: 适用于装饰, 装潢业, 硬质木材, 轻质木龙骨的连接。广泛用于民用和军工建筑的水电安装和装修。

Product type: Cement nails (ST nails)
Material: 45 steel or 60 steel
Point: Hardness is very big, thick and short, piercing ability is very strong.
Application: Suitable for decoration, upholstery, hard wood, light wood keel connection. It is widely used in the installation and decoration of civil and military buildings.



产品类型: 镀锌钉
材质: 碳钢Q195/235
特点: 抗腐蚀能力强, 坚固耐用, 不易生锈。
产品用途: 制造金属丝网、钉子、高速公路护栏及建筑工程捆绑丝等。

Product type: Galvanized nail
Material: Carbon steel Q195/235
Point: Strong corrosion resistance, durable, not easy to rust.
Application: wire mesh, nails, highway guardrail and construction binding wire, etc.



木托盘
Wooden pallets



电缆盘
Cable tray



木包装箱
Wood packing



大型框架
Large frame



家具装修
Furniture decoration



水泥钉
Concrete nail





ALEMİNSAN MAKİNE
www.aleminsan.com.tr

Yafes ALEMİN
CEO

T: +90 216 394 31 32
G: +90 532 795 55 89
F: +90 216 394 34 28
Mesit Mah. İlim Sk. No: 1 Orhanlı
Tuzla / İstanbul / Türkiye

ALEMİN SAN
SOĞUK TEL ÇEKME

ALEMİN SAN
KANEPE VE KOLTUK MEKANIZMA SİSTEMLERİ

ALEMİN SAN
SOĞUK ÇEKME LAMA

YETKİLİ SATIŞ EKİBİMİZ BÜLENT ALEMİN YAFES ALEMİN MERT ALEMİN DOĞUKAN ALEMİN

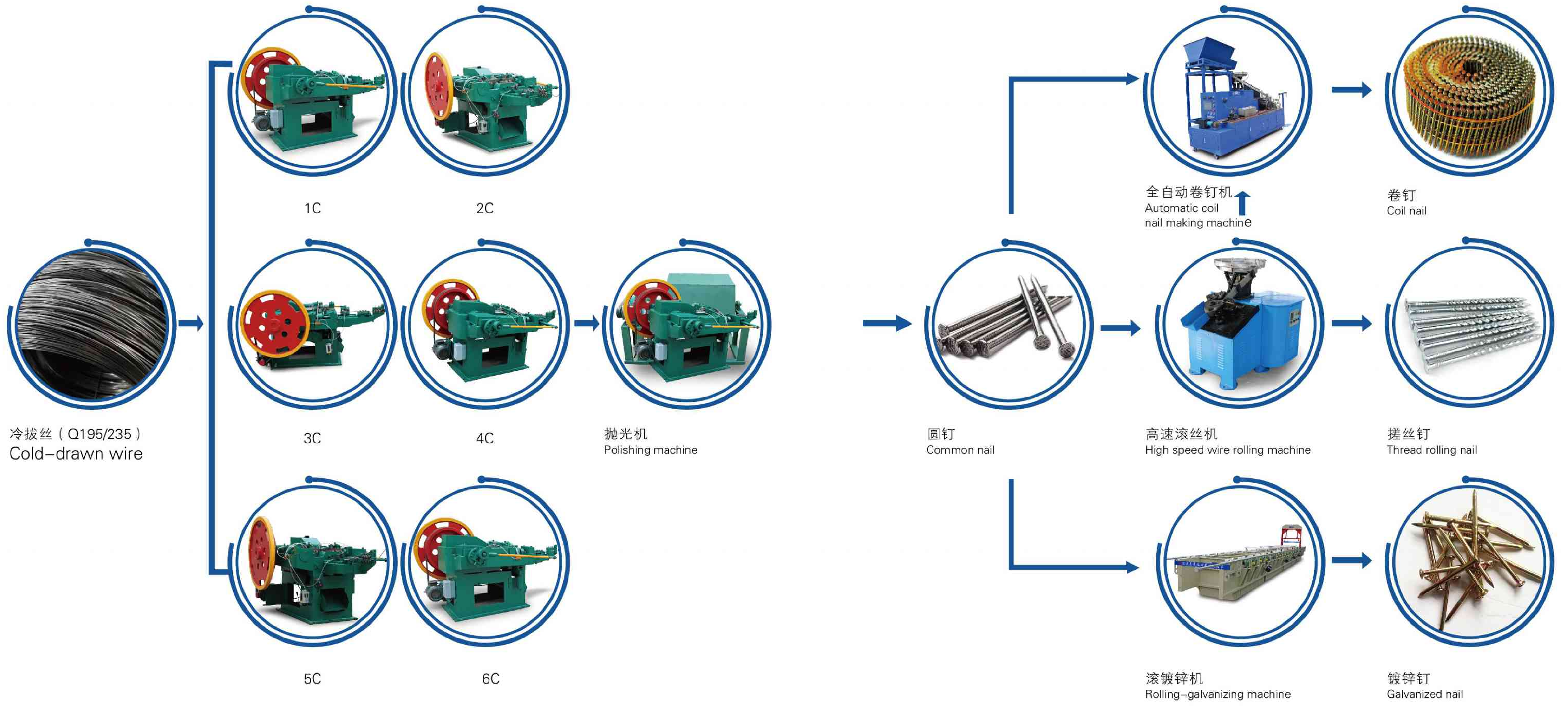



ALEMİNSAN MAKİNE
www.aleminsan.com.tr

Yafes ALEMİN
CEO

T: +90 216 394 31 32
G: +90 532 795 55 89
F: +90 216 394 34 28
Mescit Mah. İlim Sk. No: 1 Orhanlı
Tuzla / İstanbul / Türkiye



YETKİLİ SATIŞ EKİBİMİZ BÜLENT ALEMİN YAFES ALEMİN MERT ALEMİN DOĞUKAN ALEMİN

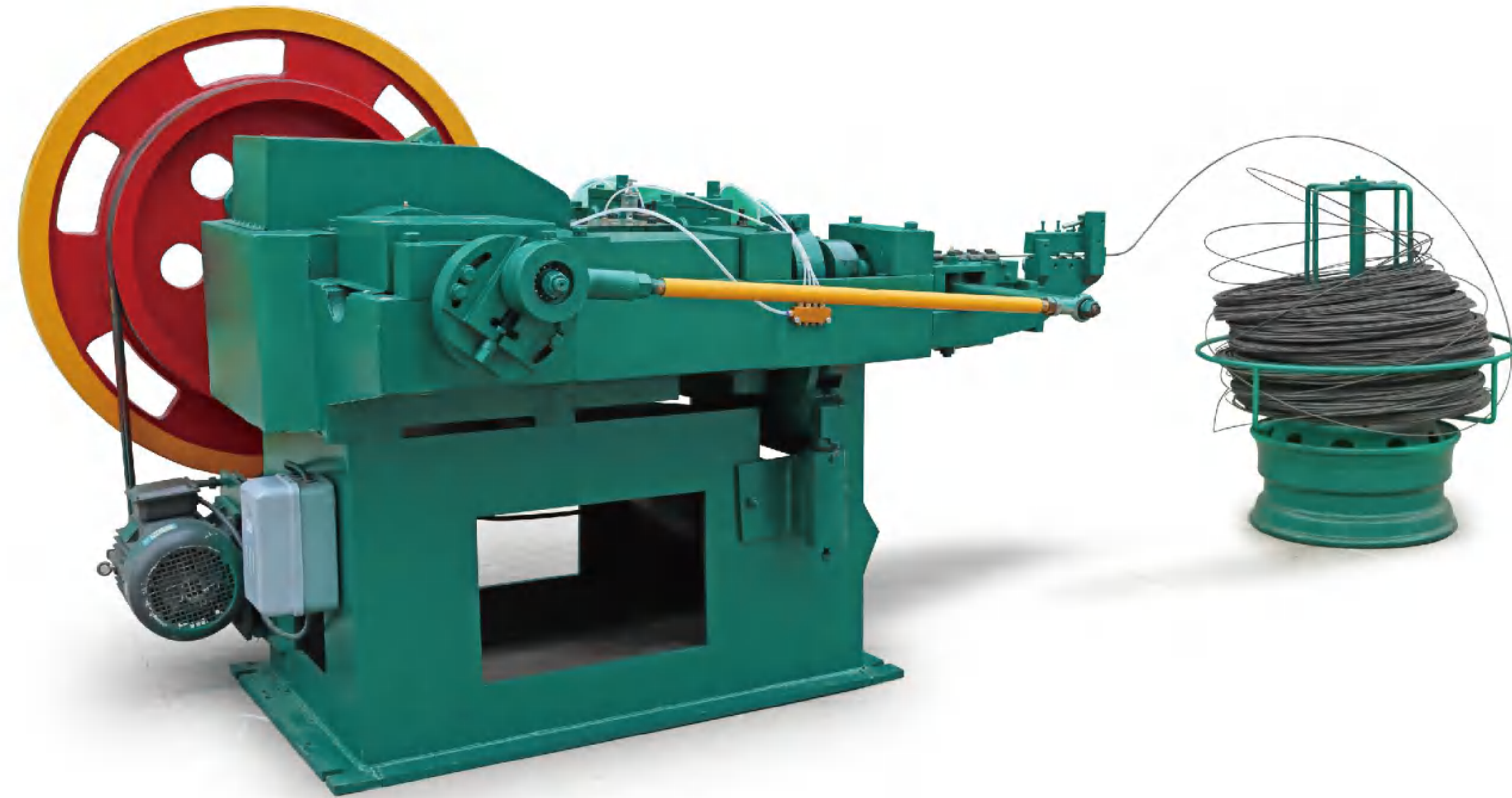

功能描述Function:

该机采用柱塞式结构保证了高速度、低噪音、少冲声的特点。设计先进，结构紧凑，外型美观，使用方便，操作安全。

This machine adopts plunger type structure to ensure the high working speed, low noise, and less sound of impact. It has the feature of advanced design, compact conformation, and good figure. It is easy and safe to operate.

型号 Type	功率 Motor power	制钉长度 Length of nail	制钉速度 Nail making speed	制钉直径 Diameter of nail	重量 Weight	外形尺寸 Dimension
1C	1.5kw	9~25mm	400~450 pcs/min	0.9~1.6mm	900KG	1350×950×1000
2C	2.2kw	16~50mm	260~350 pcs/min	1.2~2.8mm	1350KG	1650×1150×1100
3C	2.2kw	30~75mm	280~320 pcs/min	1.8~3.4mm	1600KG	1990×1200×1250
4C	4kw	50~100mm	220~280 pcs/min	2.8~4.5mm	2000KG	2280×1420×1330
5C	5.5kw	80~150mm	180~200 pcs/min	3.7~5.5mm	2500KG	2380×1580×1660
6C	11kw	150~200mm	160~180 pcs/min	4.5~6.5mm	5000KG	3500×2200×1680

High speed thread rolling machine



功能描述Function:

该机配有各种专用模具，可以生产各类异型钉类，主要用于螺纹钉、环纹钉等新型钉类。

This machine is equipped with professional moulds, can produce various kinds of shaped nails. It is mainly used to produce screw nail, spiral nail and other new type of nails.

电源电压 Voltage	三相AC380V3 phase
电机功率 Motor power	5.5KW
料斗电源 Bucket power	AC220
主轴直径 Main shaft dia	130mm
总重量 Total weight	1300KG
滚钉直径 Nail dia	1.8-4.0mm
钉身长度 Nail length	<100mm
料斗下钉量 Conveying speed	1000-1500pcs/min
生产量 Capacity	800-1300pcs/min
外形尺寸 Dimrndion (L/W/H)	1200×1600×1600mm

**全自动卷钉机
Automatic coil nail making machine**



电机功率 Motor power	2KW
焊接功率 Welding power	6KW/V
焊接电流 Welding current	1000-2000A
焊接电源 Welding source	DC290-330V
工作电源 Working power	三相three phase AC 380V 50-60HZ
适用钉子直径 Nail diameter	1.8-4.5mm
适用钉子长度 Nail length	25-100mm
速度 Speed	1250-2000Pcs/min
整机重量 Total weight	1600KG
外形尺寸 Dimrndion (L/W/H)	3800×2100×2400mm



ALEMİNSAN MAKİNE
www.aleminsan.com.tr

Yafes ALEMİN
CEO

T: +90 216 394 31 32
G: +90 532 795 55 89
F: +90 216 394 34 28
Mesit Mah. İlim Sk. No: 1 Orhanlı
Tuzla / İstanbul / Türkiye



YETKİLİ SATIŞ EKİBİMİZ BÜLENT ALEMİN YAFES ALEMİN MERT ALEMİN DOĞUKAN ALEMİN

应用范围 Range of application ●●●●●

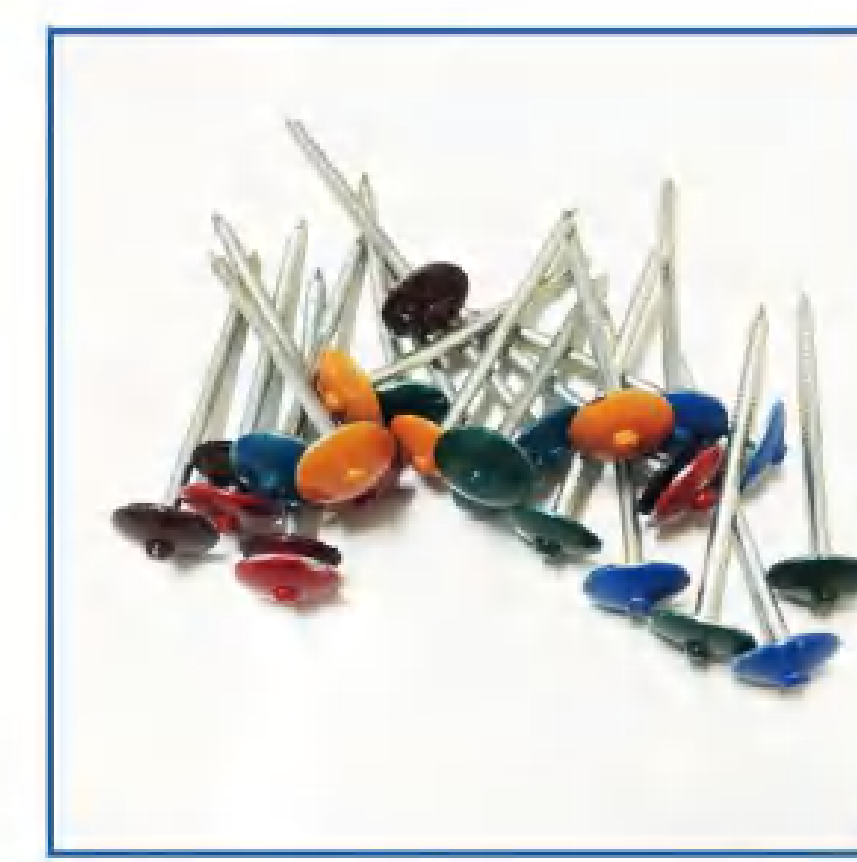
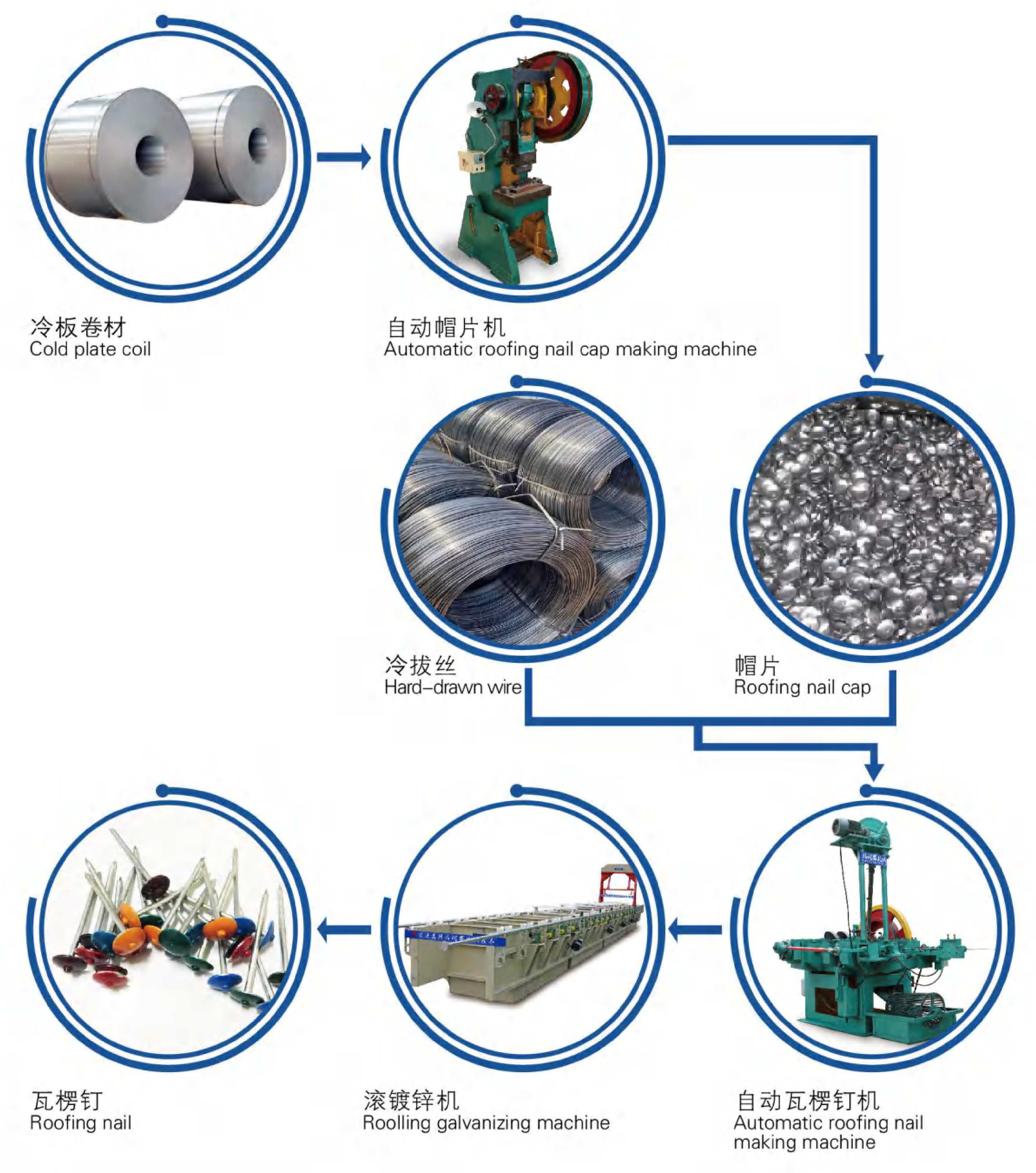

产品类型: 瓦楞钉
材质: Q195/Q235
规格: 9BWG*2 9BWG*2 1/2 10BWG*2 10BWG*2 等
公称直径: 2.8-4.2 mm
长度: 40-80mm
特点: 硬度高、韧性好、不易生锈、无污染、耐磨防腐。
产品用途: 主要用于建筑, 连接木构件, 以及石棉瓦、塑料瓦的固定。

Product type: corrugated nails
Material: Q195/Q235
Criteria: 9BWG*2 9BWG*2 1/2 10BWG*2 10BWG*2, etc
Nominal diameter: 2.8-4.2mm
Long degrees: 40-80 - mm
Point: high hardness, good toughness, not easy to rust, no pollution, wear resistance and anticorrosion.
Application: mainly used for building, connecting wood structure, and fixing asbestos tile and plastic tile.



木架装钉
Wooden frame with nail



塑料瓦固定
Plastic tile fixation



屋顶构建
Roof building



木屋搭建
Wooden structures





ALEMİNSAN MAKİNE
www.aleminsan.com.tr

Yafes ALEMİN
CEO

T: +90 216 394 31 32
G: +90 532 795 55 89
F: +90 216 394 34 28
Mescit Mah. İlim Sk. No: 1 Orhanlı
Tuzla / İstanbul / Türkiye

ALEMİN SAN
SOĞUK TEL ÇEKME

ALEMİN SAN
KANEPE VE KOLTUK MEKANIZMA SİSTEMLERİ

ALEMİN SAN
SOĞUK ÇEKME LAMA

YETKİLİ SATIŞ EKİBİMİZ BÜLENT ALEMİN YAFES ALEMİN MERT ALEMİN DOĞUKAN ALEMİN

Automatic roofing nail cap making machine

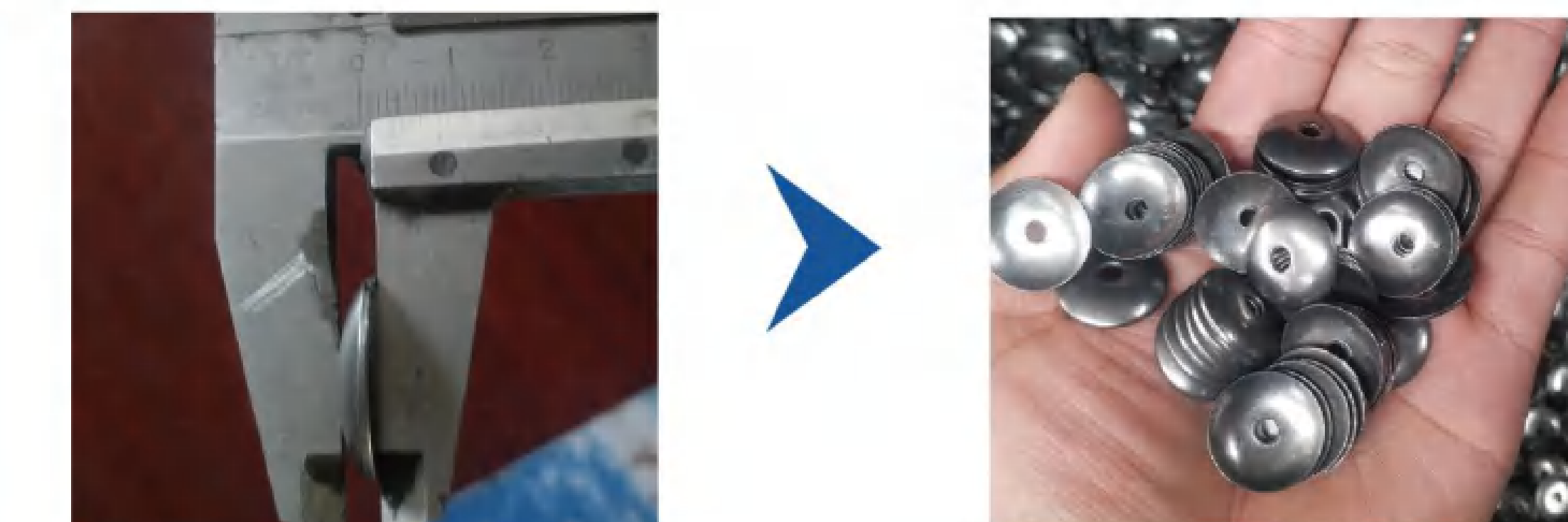

生产功率 Production efficiency (pcs/min)	6×65
电机功率 Motor power (kw)	2.2
机器重量 Weight (kg)	2300
外形尺寸 Dimension (mm)	13500×1100×2200

技术参数 Techincal data	Z94-4A
制钉最大直径 Maximum nail diameter (mm)	4.0
制钉最小直径 Minimum nail diameter (mm)	2.38
制钉最大长度 Maximum nail length (inch)	3"
制钉最小长度 Minimum nail length (inch)	1.5"
设计产量 Designed capacity (Pcs/min)	110-150
电动机功率 Motor power (kw)	4.0
重量 Weight (kg)	3000
外形尺寸 Dimension (mm)	2800×1100×2200

滚镀锌机
Rolling-Galvanizing Machine

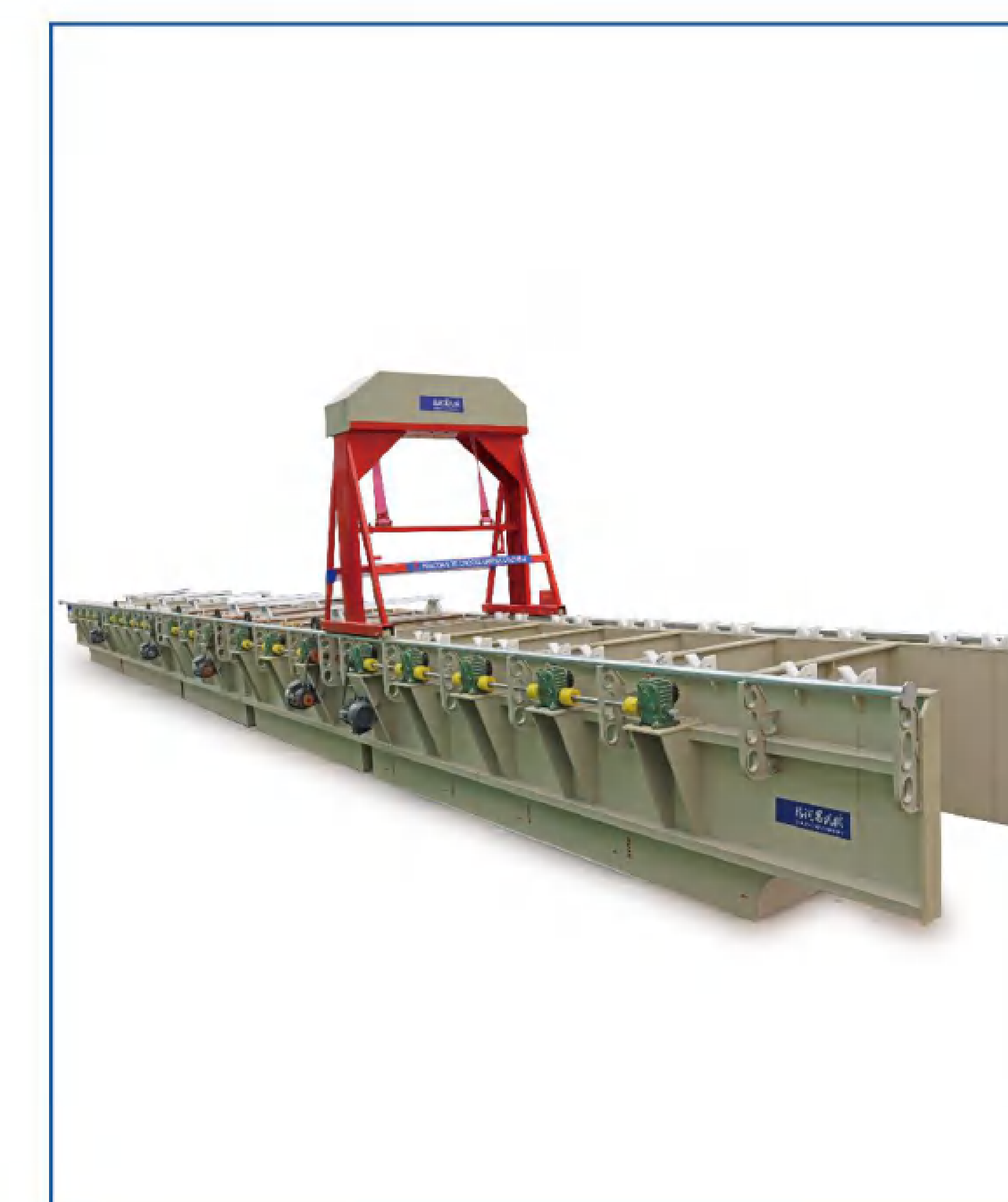

型号 Model	BGD25-1 BGD50-2
滚筒装料量 Load of roller (kg)	50-100
时间控制范围 Time control (min)	0-120
滚筒转速 Roller speed (r/min)	7-9



ALEMİNSAN MAKİNE
www.aleminsan.com.tr

Yafes ALEMİN
CEO

T: +90 216 394 31 32
G: +90 532 795 55 89
F: +90 216 394 34 28
Mesit Mah. İlim Sk. No: 1 Orhanlı
Tuzla / İstanbul / Türkiye

ALEMİN SAN
SOĞUK TEL ÇEKME

ALEMİN SAN
KANEPE VE KOLTUK MEKANIZMA SİSTEMLERİ

ALEMİN SAN
SOĞUK ÇEKME LAMA

YETKİLİ SATIŞ EKİBİMİZ BÜLENT ALEMİN YAFES ALEMİN MERT ALEMİN DOĞUKAN ALEMİN

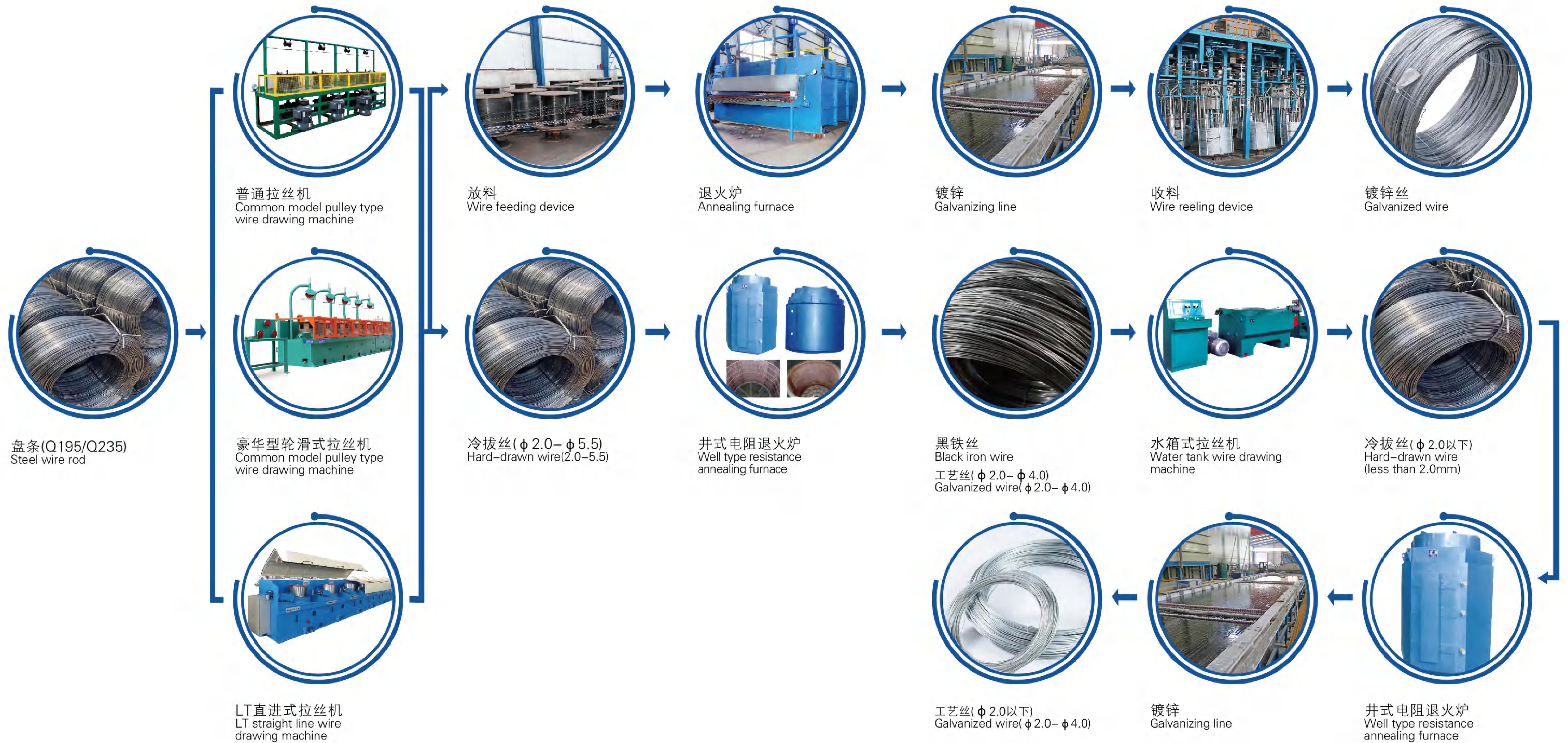



ALEMİNSAN MAKİNE
www.aleminsan.com.tr

Yafes ALEMİN
CEO

T: +90 216 394 31 32
G: +90 532 795 55 89
F: +90 216 394 34 28
Mesit Mah. İlim Sk. No: 1 Orhanlı
Tuzla / İstanbul / Türkiye



YETKİLİ SATIŞ EKİBİMİZ BÜLENT ALEMİN YAFES ALEMİN MERT ALEMİN DOĞUKAN ALEMİN

Luxurious model pulley type wire drawing machine



拉丝机技术参数Data	五联罐Five drums	四联罐Four drums	三联罐Three drums	二联罐Two drums
卷筒直径 Drum diameter (mm)	550-600	550-600	550-600	550-600
最大出线 Largest outlet (mm)	6.5	6.5	6.5	6.5
最小出线 Minimum qualification (mm)	3.0	3.8-4.0	4.5	4.8
模具 (块) Mould (pcs)	5	4	3	2
线速度 Linear velocity (m/min)	216	120-160	120-160	120-160
电机功率 Motor power (kw)	60	45	35	27
润滑方式 Lubricant type	粉Powder			

功能描述Function:

该拉丝机可拉拔高、中、低碳钢及铜、铝等线材。使用于制钉丝、电工导线、铜钢丝绳、弹簧等制造行业。采用电气控制操作简单，噪声低，效率高。

This drawing machine can be used to draw wires of low, medium and high carbon steel, copper and aluminum. It is suitable for manufacture industries of nail wire, electric leads, copper ropes, springs, etc. Adopting electrical control, it is easy for operation, of low noise and high efficiency.

型号 Model	LW1-6/350	LW1-6/450	LW1-6/550	LW1-6/560
卷筒直径 Diameter of drum (mm)	350mm	450mm	550mm	560mm
最大进线直径 Max inlet dia (mm)	2.6-1.5mm	4mm	6.5mm	6.5-4.4mm
最小出线直径 Min outlet dia (mm)	1.2-0.7mm	1.6mm	2.2mm	2.5-1.76mm
成品出线速度 Speed	227m/min	280m/min	294m/min	300m/min
单机功率 Single power	5.5kw	7.5-15kw	18.5-22kw	18.5-22kw
单机重量 Single weight (kg)	770kg	1100kg	1400kg	2000kg



ALEMINSAN MAKİNE
www.aleminsan.com.tr

Yafes ALEMİN
CEO

T: +90 216 394 31 32
G: +90 532 795 55 89
F: +90 216 394 34 28
Mescit Mah. İlim Sk. No: 1 Orhanlı
Tuzla / İstanbul / Türkiye

ALEMİN SAN
SOĞUK TEL ÇEKME

ALEMİN SAN
KANEPE VE KOLTUK MEKANİZMA SİSTEMLERİ

ALEMİN SAN
SOĞUK ÇEKME LAMA

YETKİLİ SATIŞ EKİBİMİZ BÜLENT ALEMİN YAFES ALEMİN MERT ALEMİN DOĞUKAN ALEMİN

Water tank wire drawing machine



功能描述 Function:

该设备适用于拉拔各种钢丝、焊丝等各种金属线材。
This device is used to draw various kinds of steel wire, welding wire and other metal wire materials.



拉拔道次 Times of drawing	2-11	2-11	2-11	2-12	2-12	2-12	2-12	2-9	2-9
卷筒直径 Drum dia (mm)	300	350	400	450	500	560	600	700	800
最大进线直径 Max inlet dia (mm)	2.8	3.5	4.2	5	5.5	6.5	8	10	12.7
最小出线直径 Min outlet dia (mm)	0.5	0.6	0.75	1	1.2	1.4	1.6	2.2	2.6
成品出线速度 Speed (m/s)	25	20	20	16	15	15	12	12	8
单机功率 Single power	7.5-18.5	11-22	11-30	15-37	22-45	22-55	30-75	45-90	55-110
进线强度 Input strength (MPA)	≤1250								

工字轮收线机
Spool reeling machine

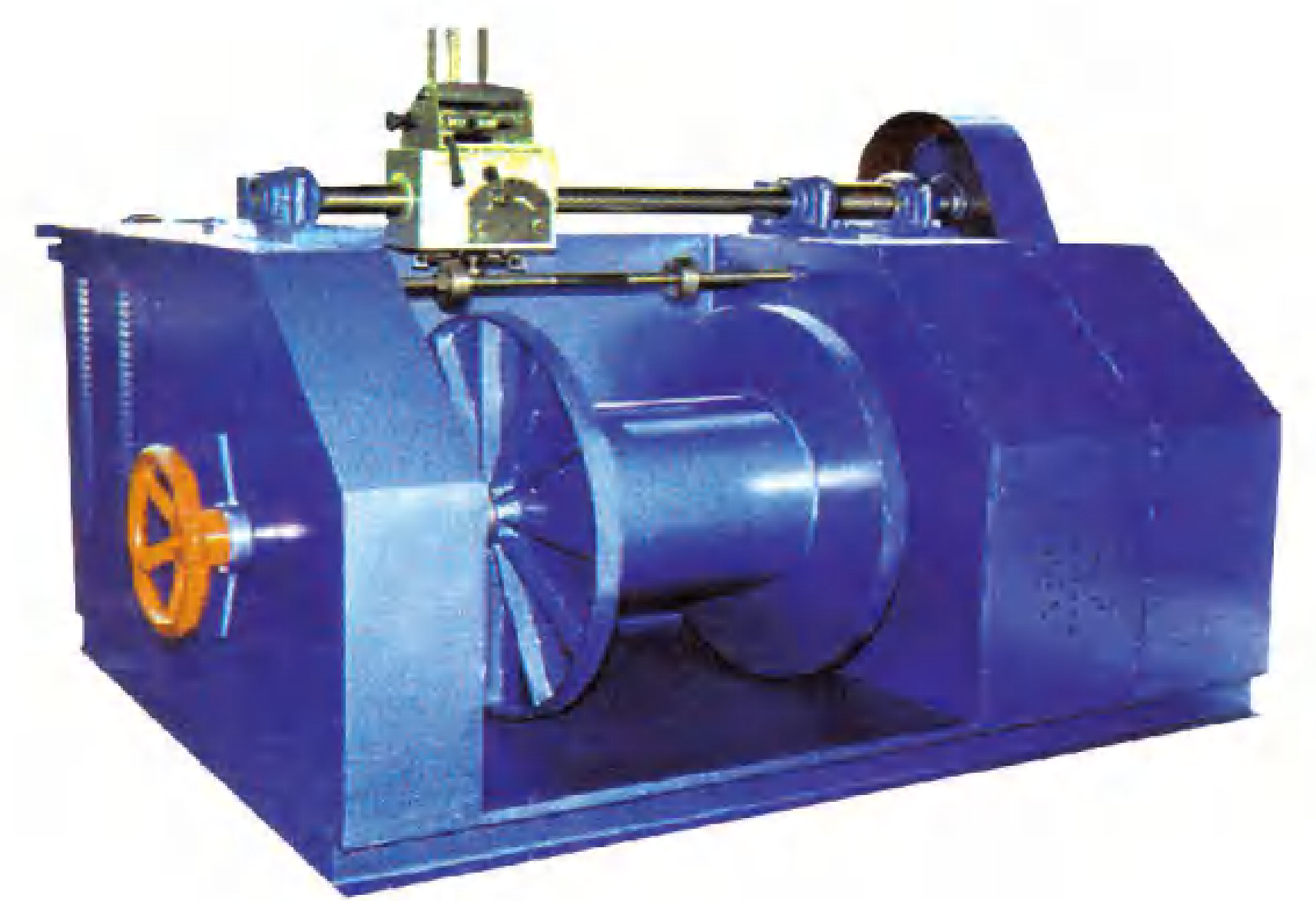

收线直径 Reeling dia	1.5-3mm	1.2-0.9mm
固定卷筒直径 Drum dia	630mm	400mm
收线重量 Reeling weight	300-500kg	150-300kg
收线速度 Reeling speed	600m/min	600m/min
配套电机 Motor	YLJ160-10-4	YLJ132-25-4
外形尺寸 Dimension	1250*1200*1000mm	1000*1000*800mm
整机重量 Total weight	1200KG	900KG

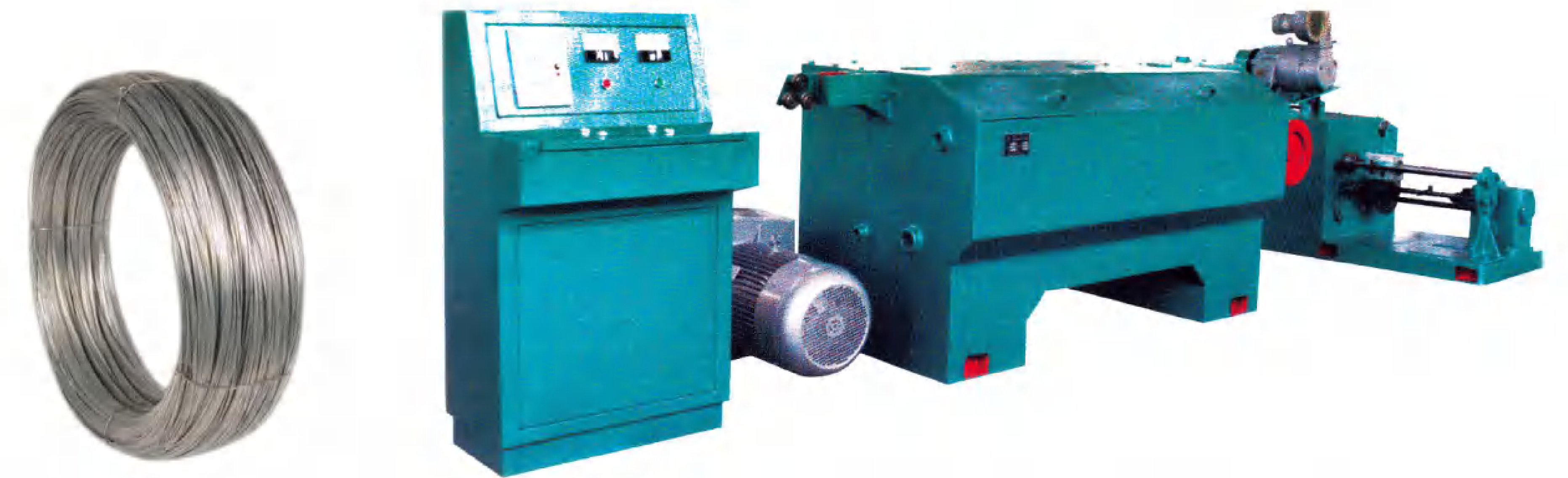

参数 Data	LT2-17/280	LT1-11/350	LT1-9/450	LT1-12/350	LT1-9/560
卷筒直径 Drum dia	280mm	350mm	450mm	350mm	560mm
拉拔模个数 Number of mould	17个	11个	9个	12个	9个
进线直径 Inlet dia	2.5-2.0mm	2.8-2.5mm	3.4-3.0mm	2.2mm	4.7mm
出线直径 Outlet dia	0.9-0.45mm	1.4-1.2mm	1.8-1.6mm	0.7mm	1.6mm
拉拔速度 Speed	500-650m/min	160-350m/min	160-300m/min	250-400m/min	280-300m/min
配用电机 Motor	22-30kw	30-45kw	37-45kw	15-18.5kw	110kw
外形尺寸 Dimension	3000*1300*1100	2400*1400*1200	3000*1500*1200	2400*1100*1100	3500*1500*1200
重量 Weight	4200kg	3300kg	4000kg	4800kg	4000kg

象鼻式收线机
Elephant nose type reeling machine



收线直径 Reeling dia	1.6-4mm
固定卷筒直径 Drum dia	600mm
收线抗拉强度 Strength	≤800MPA
收线重量 Reeling weight	800-1000KG
精拉模压缩率 Mould compression ratio	≤12%
收线速度 Reeling speed	150-300m/min
配套电机 Motor	6/15-18.5KW
外形尺寸 Dimension	2917×1470×2100
整机重量 Total weight	2300KG





ALEMINSAN MAKİNE
www.aleminsan.com.tr

Yafes ALEMİN
CEO



T: +90 216 394 31 32
G: +90 532 795 55 89
F: +90 216 394 34 28
Mesit Mah. İlim Sk. No: 1 Orhanlı
Tuzla / İstanbul / Türkiye







YETKİLİ SATIŞ EKİBİMİZ BÜLENT ALEMİN YAFES ALEMİN MERT ALEMİN DOĞUKAN ALEMİN

In-line annealing furnace



功能描述Function:

本机主要由减速器、卷筒、传动轴、机架、油槽、导丝轮等部件组成。传动由电机带动减速机作初减速，然后经链轮达到规定转速。主要用于收卷镀锌铁丝。

This machines mainly consists of reducer, drum, transmission shaft, framework, guide wheel, etc. the motor drives the reducer for primary speed-reduction, then the specified speed can be obtained via chain wheel. It is mainly used to reel galvanized iron.

卷筒直径 Diameter of drum (mm)	300-360mm
卷筒个数 Drum numbers	24-40
收线直径 Diameter of reeling (mm)	0.4-1.2
收线速度 Reeling speed (m/min)	45m/min-75
电机 Motor	Y160m-6-7.5
减速机 Speed reducer	JZQ350-2-2Z
外形尺寸 Size (mm)	9493×2810×1635
重量 Weight (kg)	3600

功能描述Function:

该设备可选用煤或天然气作为燃料，节能环保。

The equipment can choose coal or natural gas as fuel, clean energy and environmental protection.

容量 Capacity	30~60 pcs
产量 Production	4~6 t/h
耗气量 Gas consumption	22 m³/t
速度 Speed	50 m/min
净量 Weight	80000 kg
外形尺寸 Size	25000 *2000*26000 mm



ALEMİNSAN MAKİNE
www.aleminsan.com.tr

Yafes ALEMİN
CEO

T: +90 216 394 31 32
G: +90 532 795 55 89
F: +90 216 394 34 28
Mesat Mah. İlim Sk. No: 1 Orhanlı
Tuzla / İstanbul / Türkiye



YETKİLİ SATIŞ EKİBİMİZ BÜLENT ALEMİN YAFES ALEMİN MERT ALEMİN DOĞUKAN ALEMİN



调直钢筋直径 Wire Dia	1-4mm	4-8mm	4-14mm
自动切断长度 Cutting length	30-2000mm	200-6000mm	300-8300mm
切断长度误差 Cutting error	1%	1%	1%
调直速度 Straightening speed	≥25m/min	≥35m/min	≥54m/min
调直电机 Straightening motor	0.75kw	4kw	5.5kw
切断电机 Cutting motor	0.55kw	3kw	4kw
外形尺寸 Dimension	1700×350×850mm	7300×600×1240 mm	9100×986×1365mm
整机重量 Total weight	150kg	650kg	1300kg

抛光机
Polishing machine



功能描述Function:

该机主要用于各种钉子表面的除锈抛光作业。
This machine is mainly used to polish the surface rust to various kinds of nails.

型号 Model	容量 Capacity	电机功率 Motor power	外形尺寸 (mm) Dimension (mm)
300	300kg	2.2kw	1700*1300*1500
600	600kg	3kw	2000*1300*1500
1000	1000kg	4kw	2400*1300*1500
1700	1700kg	5.5kw	3000*1500*1500
2000	2000kg	7.5kw	3200*1700*1700

钢排钉粘结机
Steel nail gluing forming machine

可自动粘结ST18-ST64各规格并且烘干按需要个数切片一次完成。
Automatic bonded all the specification from ST18 TO ST64, and in the drying section, the slice can be finished by one time according to the number of need.

功能描述Function:

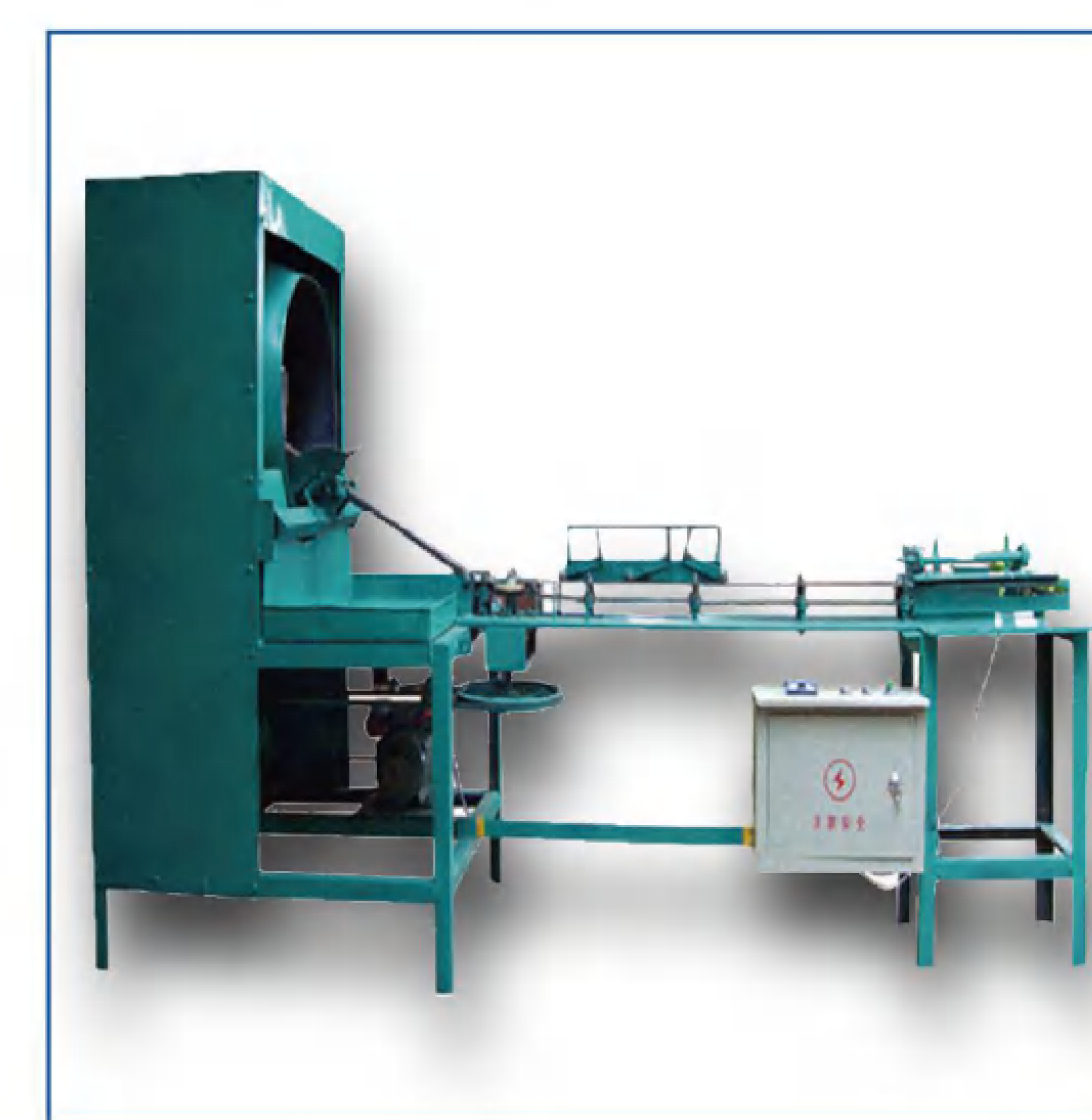

型号 Model	PD-B
配套动力 Power	380V、0.75KW
滚桶直径与转速 Diameter	φ770、12-15min/r
轨道长度 Track length	1.45m
排钉范围 Range	17-64mm
外形尺寸 Dimension	2450*700*1650mm
效率 Efficiency	1-3万只/小时 10thousand to 35 thousand pieces/hour



ALEMİNSAN MAKİNE
www.aleminsan.com.tr

Yafes ALEMİN
CEO

T: +90 216 394 31 32
G: +90 532 795 55 89
F: +90 216 394 34 28
Mescit Mah. İlim Sk. No: 1 Orhanlı
Tuzla / İstanbul / Türkiye

ALEMİN SAN
SOĞUK TEL ÇEKME

ALEMİN SAN
KANEPE VE KOLTUK MEKANİZMA SİSTEMLERİ

ALEMİN SAN
SOĞUK ÇEKME LAMA

YETKİLİ SATIŞ EKİBİMİZ BÜLENT ALEMİN YAFES ALEMİN MERT ALEMİN DOĞUKAN ALEMİN

