



HD
MEKATRONİK
VE MÜHENDİSLİK SANAYİ TİCARET LİMİTED ŞİRKETİ

"İHTİYAÇLARINIZA HD ÇÖZÜMLER SUNAR"



HAKKIMIZDA

HD MEKATRONİK 2021 YILINDA KURULMUŞ VE KURULDUĞU GÜNDEN BERİ YENİLİKÇİ TEKNOLOJİ ÇÖZÜMLER SUNAN MAKİNA İMALATI VE OTOMASYON FİRMASIDIR. UZMAN MÜHENDİS KADROSU VE 10 YILLIK SEKTÖR TECRÜBESİ İLE MÜŞTERİLERİNE HIZLI VE ETKİLİ HİZMET SUNMAKTADIR. MAKİNE İMALATI, İMALATA ÖZEL OTOMASYON VE YAZILIM ALANLARINDA UZMANLAŞMIŞTIR.

MİSYONUMUZ

MÜŞTERİLERİMİZİN İHTİYAÇLARINI ANLAYARAK, ÖZELLEŞTİRİLMİŞ TEKNOLOJİ VE TASARIMLARIMIZ İLE İŞ SÜREÇLERİNİ OPTİMİZE ETMELERİNİ SAĞLAMAK



VİZYONUMUZ

MÜŞTERİ MEMNUNİYETİNİ HER ZAMAN ÖNCELİKLİ TUTUYOR VE MÜŞTERİLERİMİZ İLE UZUN VADELİ İŞ İLİŞKİLERİ KURMAYI HEDEFLİYORUZ. TEKNOLOJİNİN GÜCÜNÜ VE SEKTÖREL TECRÜBEMİZİ KULLANARAK MÜŞTERİLERİMİZİ DÜNYA ÇAPINDA LİDER KILAN YENİLİKÇİ ÇÖZÜMLER SUNUYORUZ.

HİZMETLERİMİZ

- BALIK PROSES MAKİNALARI İMALATI VE PROSES TASARIMI
- TAVUK PROSES MAKİNALARI İMALATI VE PROSES TASARIMI
- İHTİYACA ÖZEL MAKİNA TASARIMI VE İMALATI
- ROBOTLU PAKETLEME İLE HAT SONU ÇÖZÜMLERİ
- MAKİNA OTOMASYON VE YAZILIM SİSTEMLERİ
- PROSES KONTROL
- MOTION KONTROL SİSTEMLER
- SCADA SİSTEMLERİ
- YEM FABRİKASI OTOMASYONU
- SOĞUK HAVA DEPOSU OTOMASYONU

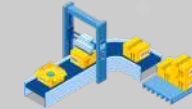
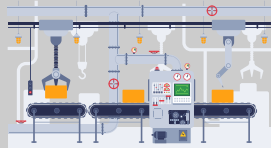

HD BIGLINE-200-12 LEVREK ÇİPURA BOYLAMA HATTI

YÜKSEK HIZ VE DOĞRULUK
100-110 ADET\DAKİKA



- KULLANICI DOSTU MODÜLER YAPI
- TÜM YÜZEYLER PASLANMAZ ÇELİK
- HİJYENİK TASARIM
- IP 67 KORUMA SINIFINA SAHİP
- YÜKSEK KALİTE
- HIZLANDIRMA VE AÇMA ÜNİTESİ
- OTOMATİK KAPAKLI KEFELER
- YERLİ ÜRETİM\YERLİ MARKA

HD BIGLINE-200-12 LEVREK ÇİPURA BOYLAMA HATTI, BALIK İŞLEME SÜRECİNİ DÜŞÜK FİRE, YÜKSEK HIZ, DOĞRULUK VE VERİM İLE OPTİMİZE İÇİN MÜKEMMEL BİR ÇÖZÜMDÜR.

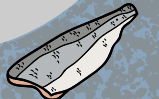
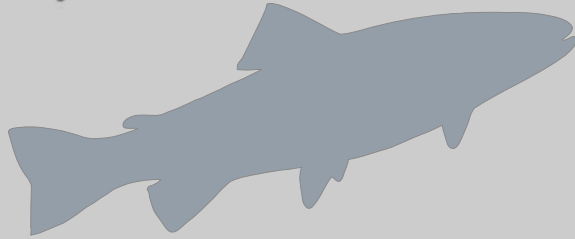

GENEL ÖZELLİKLER

- LİVAR İÇERİSİNDE GELEN BALIKLAR LİVAR DEVİRME MAKİNASI İLE HATTA AKTARILIR.
- BESLEME KONVEYÖRÜNDEN GELEN BALIKLAR DİNAMİK TARTIM ÜNİTESİNDE +/- 5Gr HASSASİYETLE TARTILIR.
- KADEMELİ HIZLANDIRMA ÜNİTESİ SAYESİNDE ÜRÜNLERE DOĞRU ARALIK VERİLİR BU SAYEDE DOĞRU TARTIM YAPILIR.
- TARTIMI YAPILAN BALIKLAR AĞIRLIĞINA GÖRE BELİRLENMİŞ KEFELERE AKTARILIR.
- HD-BIGLINE-200-12 LEVREK, ÇİPURA BOYLAMA HATTI 12 KEFELİ TASARLANMIŞ OLUP İHTİYACA GÖRE KAPASİTESİ 6 VEYA 6+6, 8 VEYA 8+8, 12 VEYA 12+12 KEFE OPSİYONLARI MEVCUTTUR.
- HD-BIGLINE-200-12 LEVREK, ÇİPURA BOYLAMA HATTI DOĞRU BESLEME YAPILDIĞINDA DAKİKADA 100-120 BALIK GRUPLAMA KAPASİTESİNE SAHİPTİR.

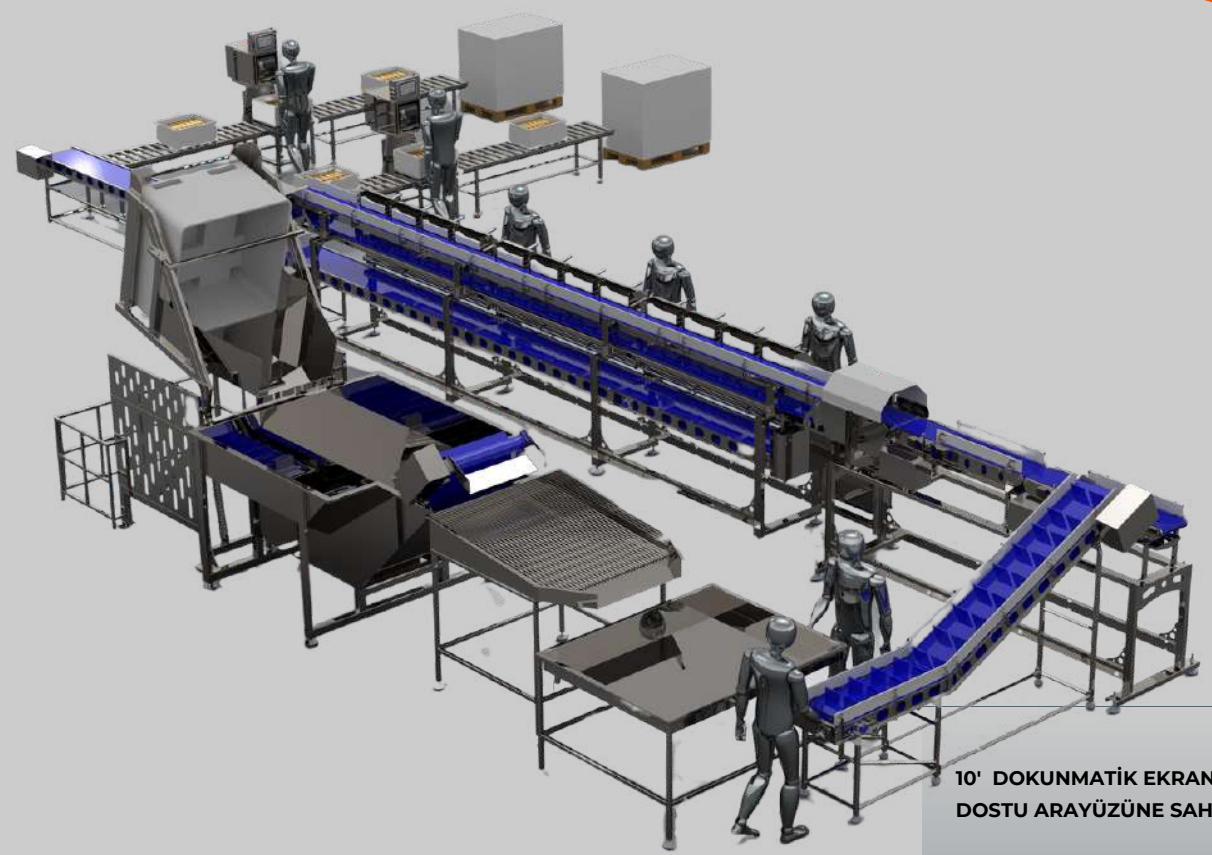

10' DOKUNMATİK EKRANI İLE KOLAY, KULLANICI DOSTU ARAYÜZÜNE SAHİPTİR.

- ADET VEYA AĞIRLIK ENDEKSLİ GRUPLAMA SEÇENEKLERİ
- İSTENİLEN AĞIRLIĞA VEYA ADETE ULAŞAN KEFE IŞIKLI İKAZLA UYARILIR.
- OTOMATİK KAPAKLI KEFE SAYESİNDE DOLAN KEFE KAPAĞI KAPANIR.
- HER KEFEDE BULUNAN DOKUNMATİK TUŞ SAYESİNDE KEFE SIFIRLANIR.
- DOLUMU BİTEN KUTUYA AİT BİLGİLER HDKONTROL PROGRAMINDA TASARLANMIŞ ÜRÜN ETİKETİNE TERMAL YAZICI İLE OTOMATİK OLARAK YAZDIRILIR.

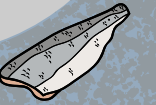

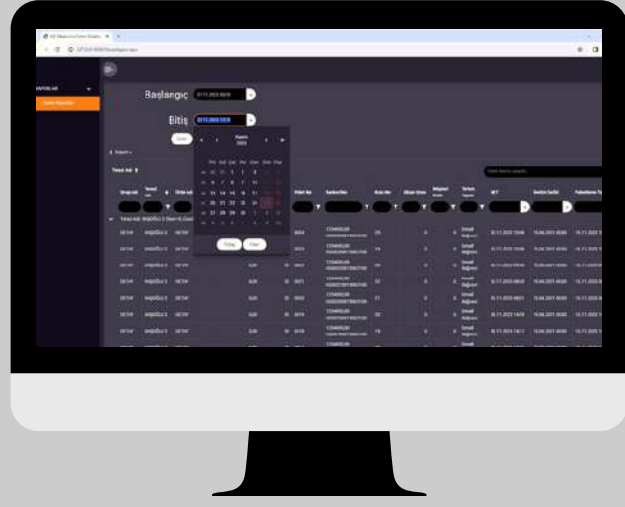

GENEL ÖZELLİKLER

- MAKİNE ÜZERİNDEKİ YAZILIM İLE WEB RAPORLAMA VE ANLIK ÜRETİM TAKİBİ.
- UZAKTAN ERIŞİM İLE KOLAY SERVİS HİZMETİ
- HDCONTROL UYGULAMASININ KOLAY ARAYÜZÜ İLE HER DİLDE KUTU VE PALET ETİKET TASARIMI.
- İSTENİLEN KONFIGURASYONLARDA AYARLANABİLİR VE KAYDEDİLEBİLİR REÇETE UYGULAMASI.

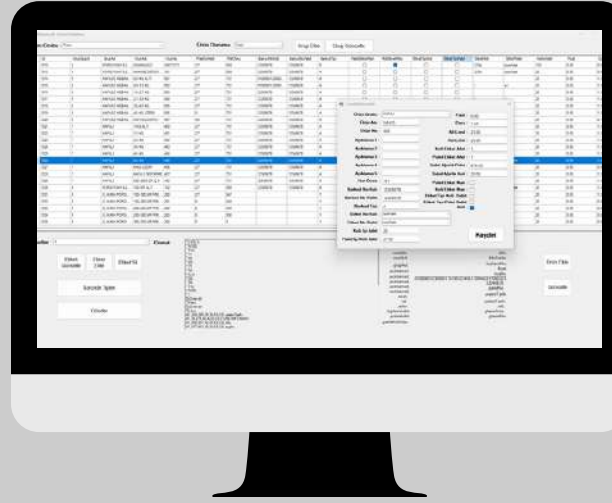
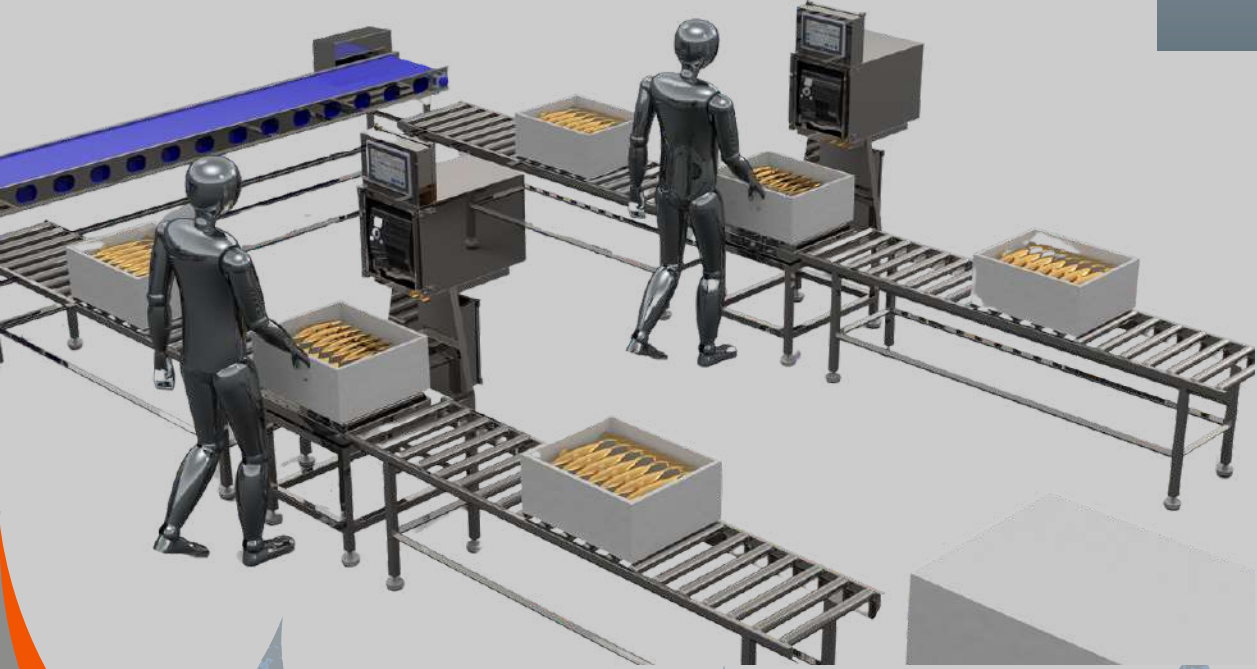

-MAKİNAMIZDA KEFE OPSİYONLARI SUNULMUŞ OLUP FARKLI PROJELERİNİZE GÖRE FİRMAYA ÖZGÜ TASARIMLAR YAPILABİLMEKTEDİR.

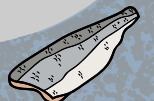

HD BIGLINE-100-06
SOMON BOYLAMA MAKİNESİ\GRADER

YÜKSEK HIZ VE DOĞRULUK
50-55 ADET\DAKİKA

- KULLANICI DOSTU MODÜLER YAPI
- TÜM YÜZEYLER PASLANMAZ ÇELİK
- HİJYENİK TASARIM
- IP 67 KORUMA SINIFINA SAHİP
- YÜKSEK KALİTE
- YERLİ ÜRETİM\YERLİ MARKA

HD BIGLINE-100-06 SOMON GRUPLAMA MAKİNASI, BALIK İŞLEME SÜRECİNİ DÜŞÜK FİRE, YÜKSEK HIZ, DOĞRULUK VE VERİM İLE OPTİMİZE İÇİN MÜKEMMEL BİR ÇÖZÜMDÜR.

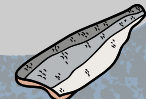
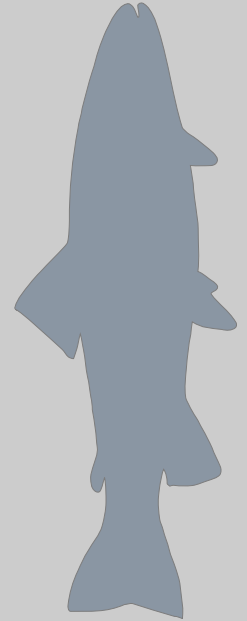

GENEL ÖZELLİKLER

- İHTİYACA GÖRE LEVREK, ÇİPURA, DONUK FLETO GRUPLAMALARINA ÖZEL TASARIMLARIMIZ MEVCUTTUR
- BESLEME KONVEYÖRÜNDEN GELEN BALIKLAR DİNAMİK TARTIM ÜNİTESİNDE +/- 5Gr HASSASİYETLE TARTILIR.
- TARTIMI YAPILAN BALIKLAR AĞIRLIĞINA GÖRE BELİRLENMİŞ KEFELERE AKTARILIR.
- HD-BIGLINE-100-6 SOMON BOYLAMA MAKİNESİ 6 KEFELİ TASARLANMIŞ OLUP İHTİYACA GÖRE KAPASİTESİ 6 VEYA 6+6, 8 VEYA 8+8, 12 VEYA 12+12 KEFE OPSİYONLARI MEVCUTTUR.
- HD-BIGLINE-100-6 SOMON BOYLAMA MAKİNESİ DOĞRU BESLEME YAPILDIĞINDA DAKİKADA 55-60 BALIK GRUPLAMA KAPASİTESİNE SAHİPTİR.
-

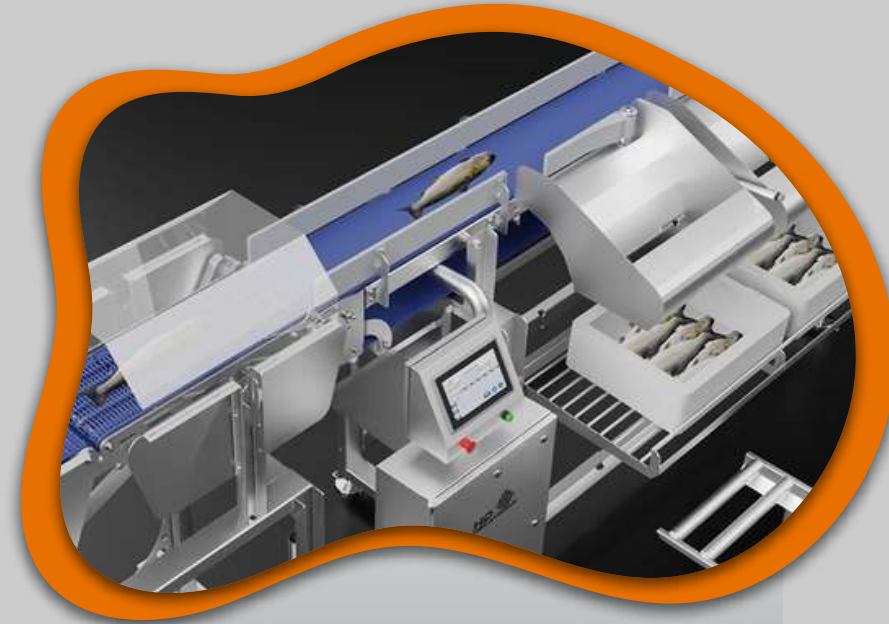

- 10' DOKUNMATİK EKRANI İLE KOLAY, KULLANICI DOSTU ARAYÜZÜNE SAHİPTİR.
- ADET VEYA AĞIRLIK ENDEKSLİ GRUPLAMA SEÇENEKLERİ
- İSTENİLEN AĞIRLIĞA VEYA ADETE ULAŞAN KEFE IŞIKLI İKAZLA UYARILIR.
- HER KEFEDE BULUNAN DOKUNMATİK TUŞ SAYESİNDE KEFE SIFIRLANIR.
- DOLUMU BİTEN KUTUYA AİT BİLGİLER HDKONTROL PROGRAMINDA TASARLANMIŞ ÜRÜN ETİKETİNE TERMAL YAZICI İLE OTOMATİK OLARAK YAZDIRILIR.

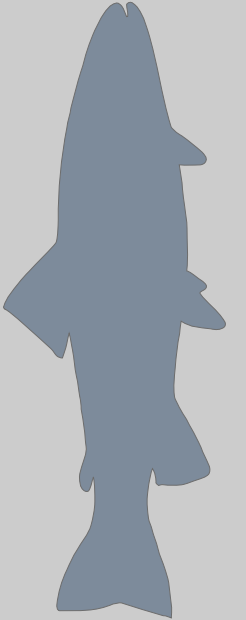
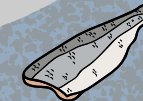

HD BIGLINE-300-08 DONUK BOYLAMA MAKİNESİ

- KULLANICI DOSTU MODÜLER YAPI
- TÜM YÜZEYLER PASLANMAZ ÇELİK
- HİJYENİK TASARIM
- IP 67 KORUMA SINIFINA SAHİP
- YÜKSEK KALİTE
- YERLİ ÜRETİM\YERLİ MARKA

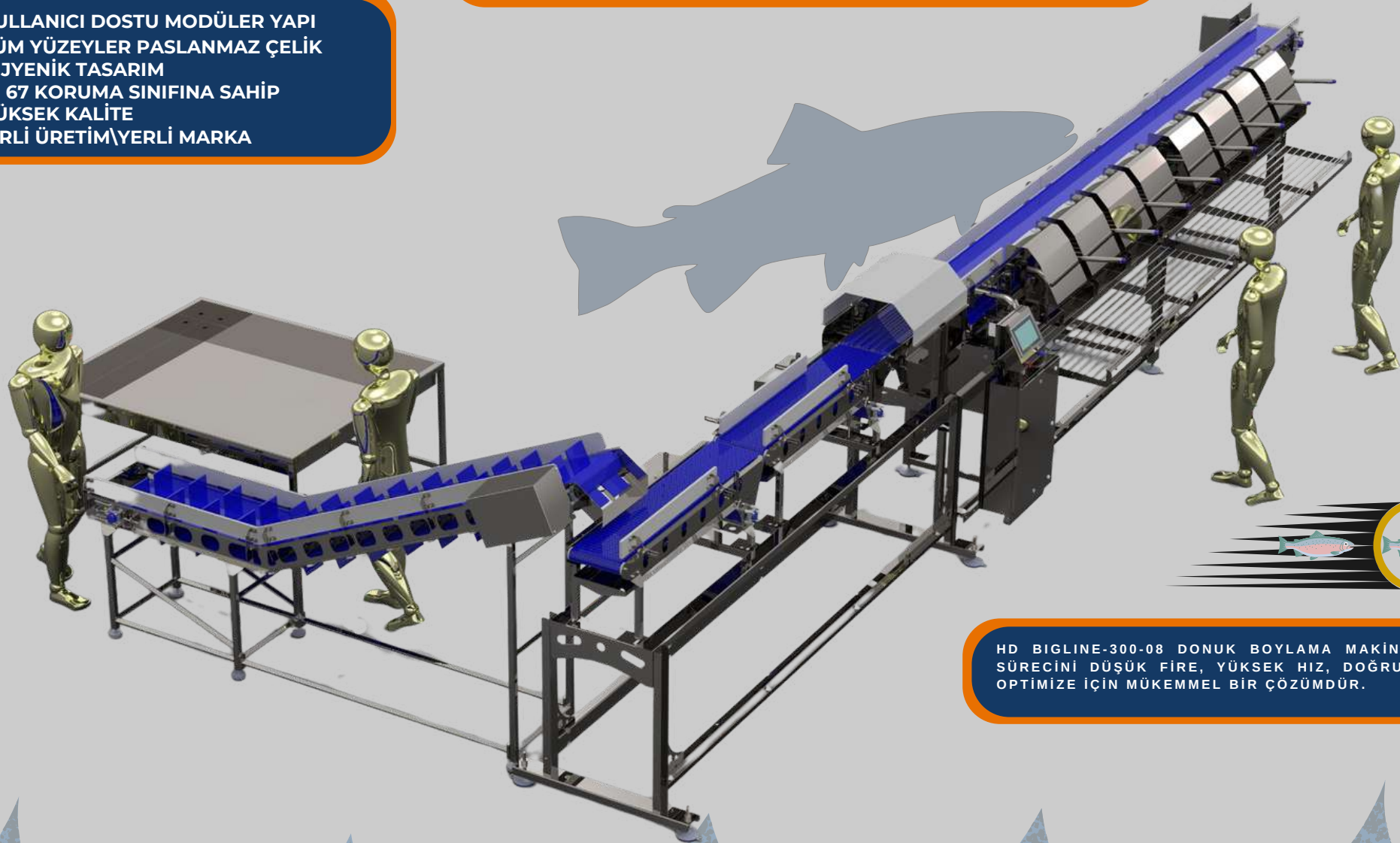

YÜKSEK HIZ VE DOĞRULUK
85-90 ADET\DAKİKA

HD BIGLINE-300-08 DONUK BOYLAMA MAKİNESİ, BALIK İŞLEME SÜRECİNİ DÜŞÜK FİRE, YÜKSEK HIZ, DOĞRULUK VE VERİM İLE OPTİMİZE İÇİN MÜKEMMEL BİR ÇÖZÜMDÜR.



GENEL ÖZELLİKLER

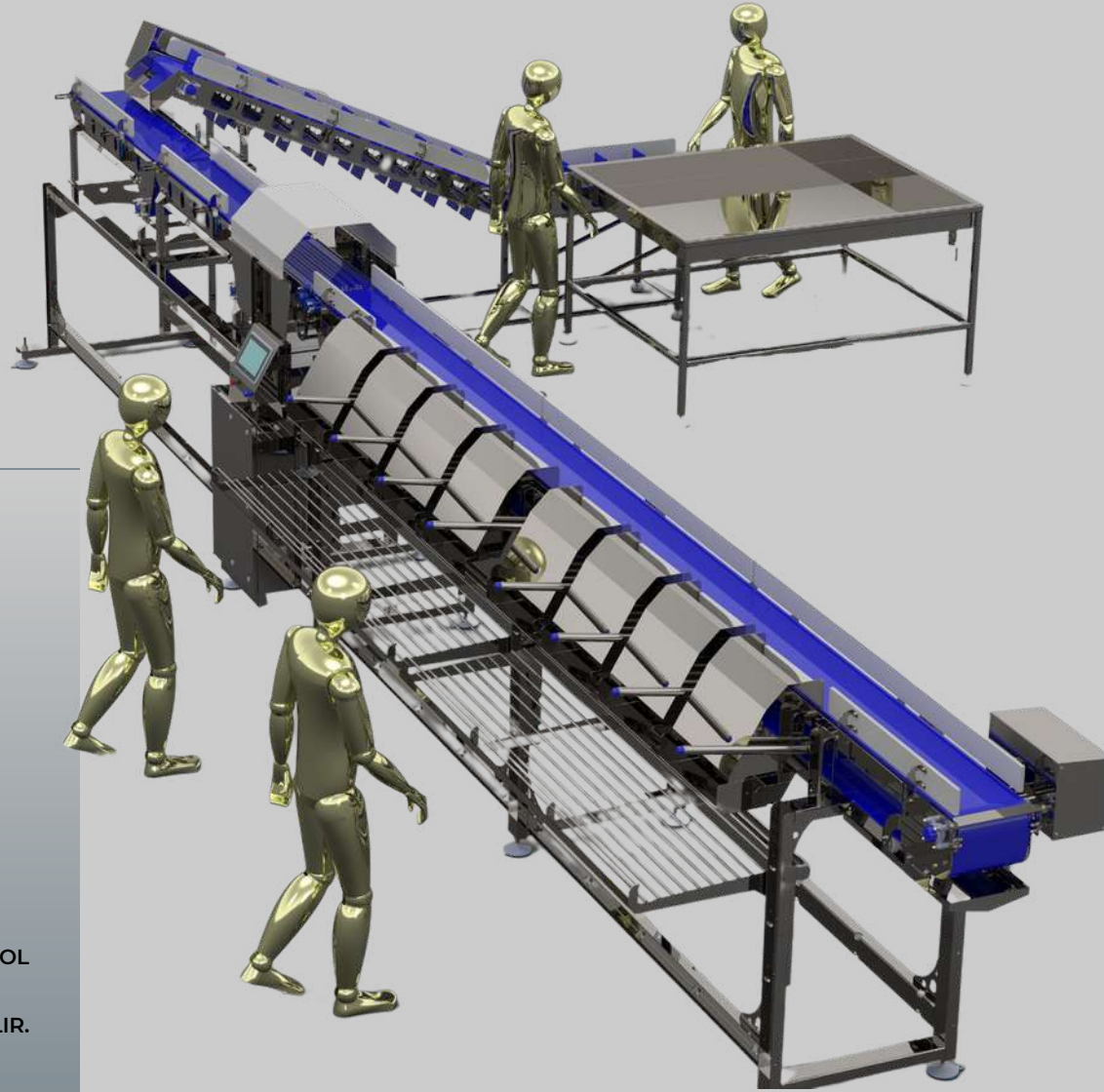

- 10' DOKUNMATİK EKRANI İLE KOLAY, KULLANICI DOSTU ARAYÜZÜNE SAHİPTİR.
- ADET VEYA AĞIRLIK ENDEKSLİ GRUPLAMA SEÇENEKLERİ
- İSTENİLEN AĞIRLIĞA VEYA ADETE ULAŞAN KEFE IŞIKLI İKAZLA UYARILIR.
- HER KEFEDE BULUNAN DOKUNMATİK TUŞ SAYESİNDE KEFE SIFIRLANIR.
- DOLUMU BİTEN KUTUYA AİT BİLGİLER HDKONTROL PROGRAMINDA TASARLANMIŞ ÜRÜN ETİKETİNE TERMAL YAZICI İLE OTOMATİK OLARAK YAZDIRILIR.

- BESLEME KONVEYÖRÜNDEN GELEN DONUK BALIKLAR DİNAMİK TARTIM ÜNİTESİNDE +/- 5Gr HASSASİYETLE TARTILIR.
- TARTIMI YAPILAN BALIKLAR AĞIRLIĞINA GÖRE BELİRLENMİŞ KEFELERE AKTARILIR.
- HD-BIGLINE-300-08 DONUK BOYLAMA MAKİNESİ 8 KEFELİ TASARLANMIŞ OLUP İHTİYACA GÖRE KAPASİTESİ 6 VEYA 6+6, 8 VEYA 8+8, 12 VEYA 12+12 KEFE OPSİYONLARI MEVCUTTUR.
- HD-BIGLINE-300-8 LEVREK, ÇİPURA BOYLAMA HATTI DOĞRU BESLEME YAPILDIĞINDA DAKİKADA 90-100 BALIK GRUPLAMA KAPASİTESİNE SAHİPTİR.

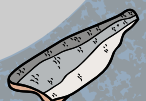

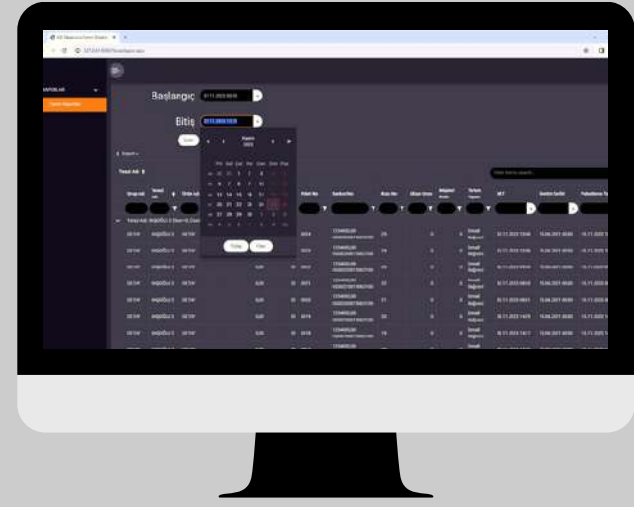

6'LI KEFE

6+6'LI KEFE

8'LI KEFE

8+8'LI KEFE

12'LI KEFE

12+12'LI KEFE

KEFE
OPSİYONLARI

GENEL ÖZELLİKLER

- MAKİNE ÜZERİNDEKİ YAZILIM İLE WEB RAPORLAMA VE ANLIK ÜRETİM TAKİBİ.
- UZAKTAN ERİŞİM İLE KOLAY SERVİS HİZMETİ
- HDCONTROL UYGULAMASININ KOLAY ARAYÜZÜ İLE HER DİLDE KUTU VE PALET ETİKET TASARIMI.
- İSTENİLEN KONFIGURASYONLARDA AYARLANABİLİR VE KAYDEDİLEBİLİR REÇETE UYGULAMASI.

-MAKİNAMIZDA KEFE OPSİYONLARI
SUNULMUŞ OLUP FARKLI
PROJELERİNİZE GÖRE FİRMAYA ÖZGÜ
TASARIMLAR YAPILABİLMEKTEDİR.

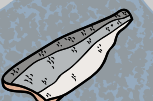
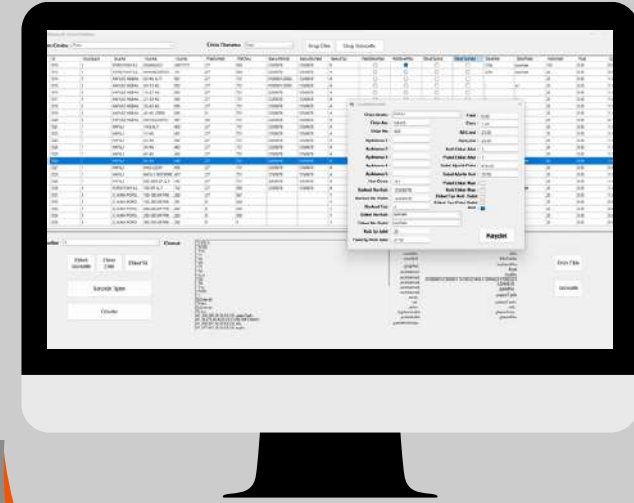

HD-LD-500-01 LİVAR DEVİRME MAKİNESİ

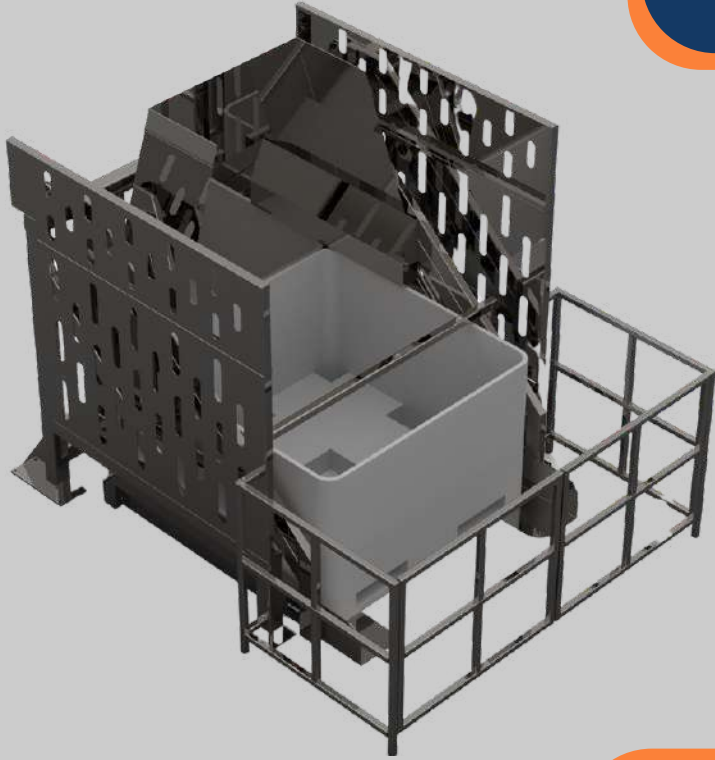

- TÜM YÜZEYLER PASLANMAZ ÇELİK
- HİJYENİK TASARIM
- HİDROLİK SİSTEM
- YÜKSEK KALİTE
- ZAMANDAN VE İŞGÜCÜNDEN TASARRUF
- YERLİ ÜRETİM\YERLİ MARKA

HD-LD-500-01 ÜRETİM ALANLARINDA İNSAN GÜCÜNÜN KALDIRAMAYACAĞI AĞIRLIKTAKİ LİVAR İÇERİSİNDE BULUNAN BALIK, TAVUK , MEVYE, SEBZE GİBİ ÜRÜNLERİN DEVİRME YÖNTEMİYLE ÜRETİM HATTINI BESLEMESİNİ SAĞLAYAN ENDÜSTRİYEL MAKİNADIR .

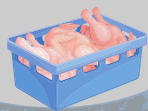
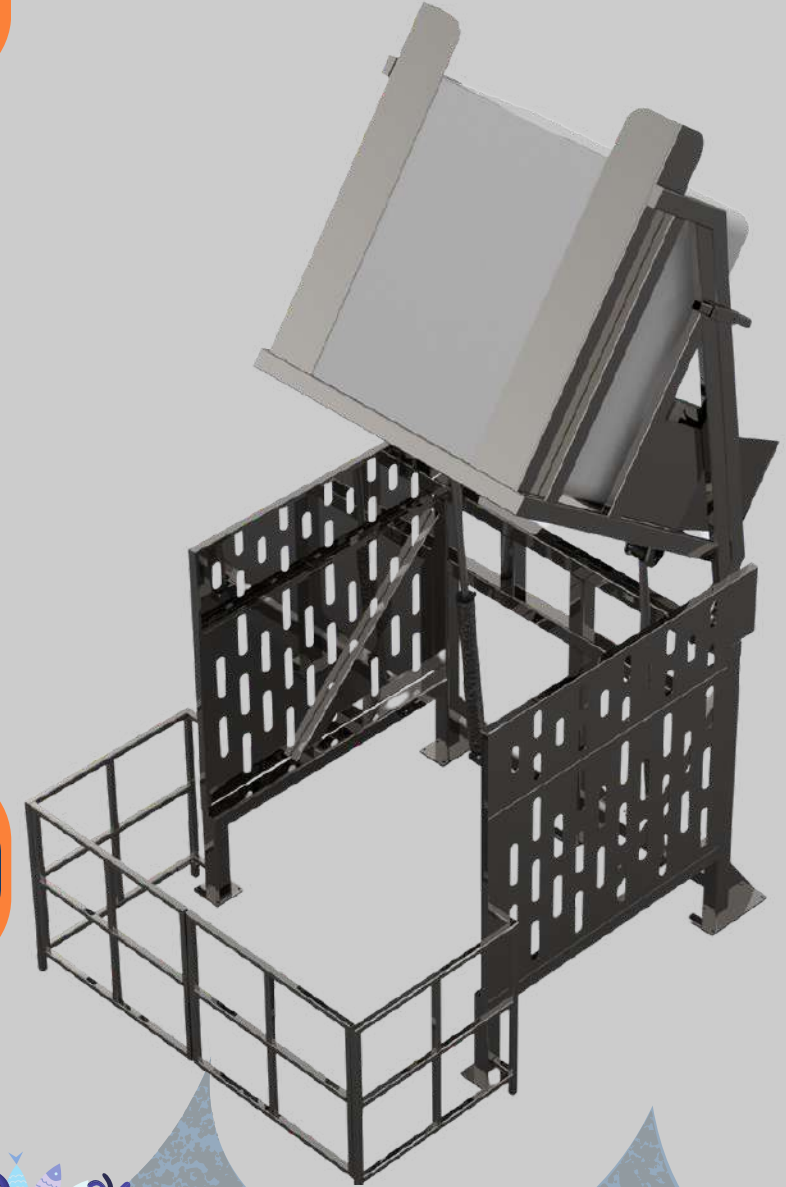

GENEL ÖZELLİKLER

✓ ÇİFT PİSTONLU HİDROLİK
DEVİRİCİ

✓ 500Kg, 750Kg VE 1000Kg YÜK
KALDIRMA SEÇENEKLERİ

✓ AYARLANABİLİR DEVİRME HIZI

✓ MODÜLER YAPI

✓ 120° 'YE KADAR DEVİRME AÇISI

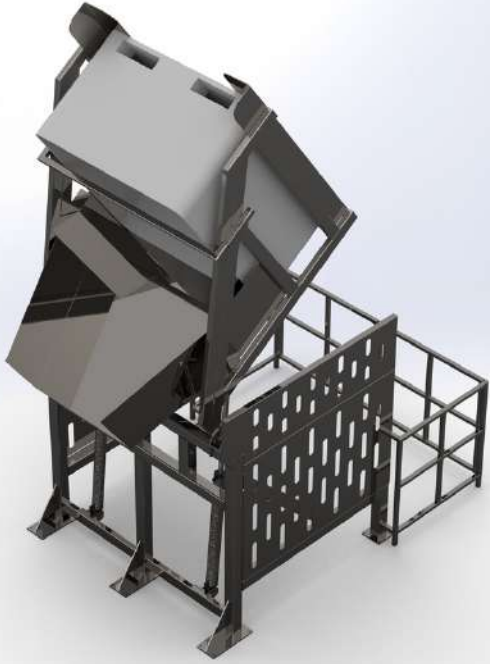

✓ ÇALIŞMA VOLTAJİ 3 FAZ 380V

✓ KUMANDA KONTROL PANOSU

✓ PASLANMAZ ÇELİK TEN
SAĞLAM ŞASI

✓ MÜŞTERİ TALEBİNE GÖRE
FARKLI EBAT VE ÖLÇÜLERDE
ÜRETİM YAPILABİLMEKTEDİR.

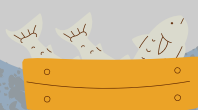
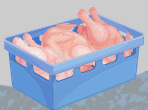

HD-GLZ-600-01 GLAZE MAKİNASI

- TÜM YÜZEYLER PASLANMAZ ÇELİK
- HİJYENİK TASARIM
- YÜKSEK KALİTE
- DALDIRMA GLEZE YÖNTEMİ
- HIZ AYARLI KONVEYÖR
- YERLİ ÜRETİM\YERLİ MARKA

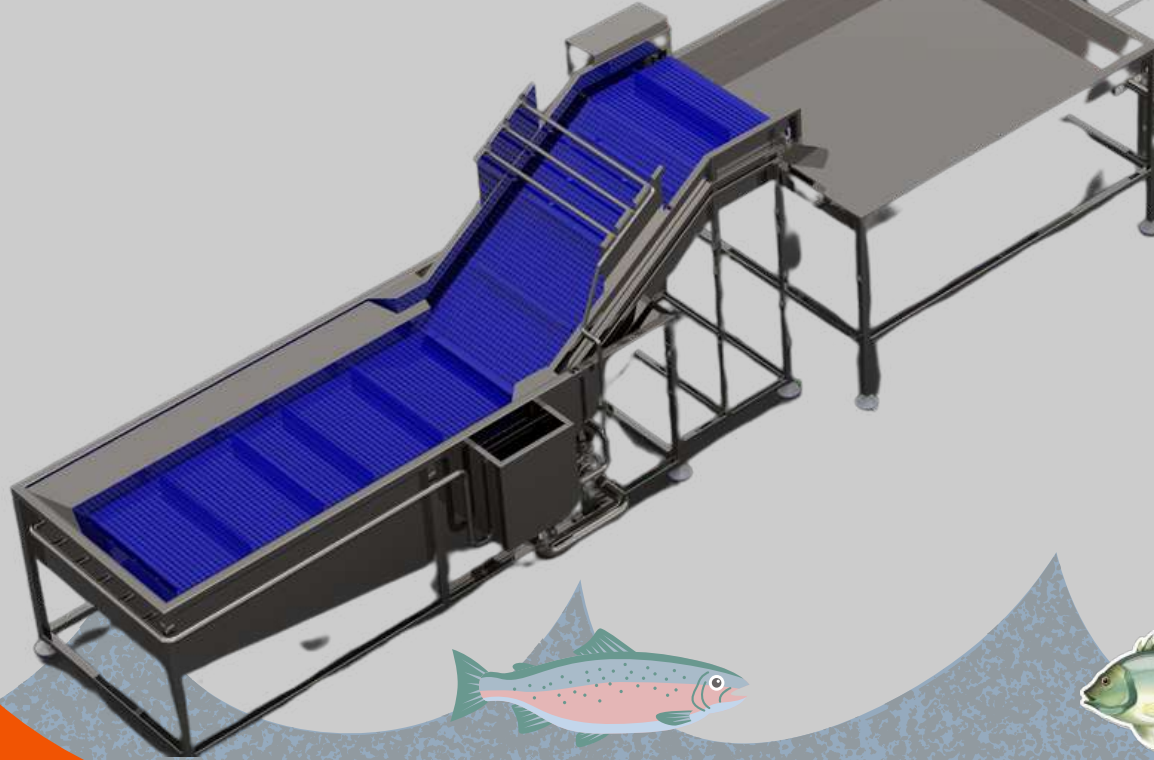

GLEZELEME; BALIK ÜRÜNLERİNİN UZUN SÜRELİ MUHAFAZASI İÇİN YAPILAN DONDURMA İŞLEMİNDEN SONRA ÜRÜNLERİN KALİTESİNİ KORUMAK İÇİN SOĞUK SUYA DALDIRILARAK YÜZEYİNE BUZ TABAKASI KAPLAMA İŞLEMİDİR.

HD-GLZ-600-01 GLAZE MAKİNAMIZLA BALIK ÜRÜNLERİNİN 0 DERECE SOĞUK SUYA DALDIRILARAK YÜZEYİ BUZ TABAKASIYLA KAPLANIR BU SAYEDE OKSİDASYONUN ÖNÜNE GEÇİLEREK HEM ÜRÜN KALİTESİ MUHAFAZA EDİLİR HEM DE ÜRÜN RAF ÖMRÜ UZATILMIŞ OLUR.

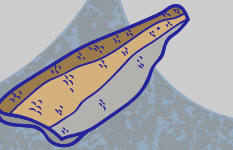
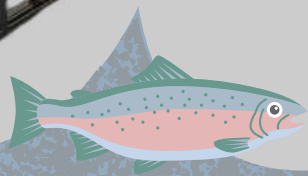

GENEL ÖZELLİKLER

✓TÜM YÜZEYLER ANSI 304 PASLANMAZ
ÇELİK

✓BUZ HAZNELİ 400L SU DALDIRMA TANKI

✓ AYARLANABİLİR BANT HIZI

✓ 1,5 KW POMPA İLE DEVİRDİM

✓ MODULER YAPI

✓ BÜTÜN BALIK TÜRLERİ, FLETOLARI VE
YUMUŞAKCALAR İÇİN UYGUNDUR.

KONVEYÖR BANT GENİŞLİĞİ 800mm

✓ ÇALIŞMA VOLTAJİ 3 FAZ 380V

✓ MAKİNA KAPASİTESİ 1000 KG\SAAT

✓ MÜŞTERİ İSTEĞİNE GÖRE FARKLI
EBATLARDA TASARIMLAR YAPILABİLİR

✓MAKİNE EBATLARI
UZUNLUĞU: 3700mm
GENİŞLİĞİ: 1750mm
YÜKSEKLİĞİ: 1750mm

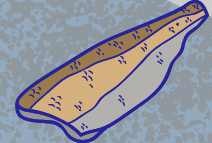

HD-FLT-800-01 MANUAL FİLETOLAMA HATTI

KASA BÖLÜMÜNDEN GELEN İŞLENMEMİŞ ÜRÜNLER
FİLETO TEZGAHINDA PERSONEL TARAFINDAN
İŞLENEREK İŞLENMİŞ ÜRÜN BÖLÜMÜNE AKTARILIR

- TÜM YÜZEYLER PASLANMAZ ÇELİK
- HİJYENİK TASARIM
- YÜKSEK KALİTE
- MANUAL FİLETOLAMA MASALARI
- GIDA NORMLARINA UYGUN
- YERLİ ÜRETİM\YERLİ MARKA

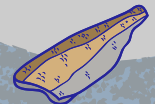

GENEL ÖZELLİKLER

✓ İŞLENMİŞ VE İŞLENMEMİŞ ÜRÜNLER İÇİN
AYRI KASA BÖLÜMLERİ

✓ KOLAY TEMİZLENEBİLİR YAPI

✓ AYARLANABİLİR BASAMAK YÜKSEKLİĞİ

✓ İSTEĞE BAĞLI KONTROL TERAZİLERİ
EKLENEREK VERİMLİLİK UYGULAMASI
YAPILABİLİR.

✓ HAT EBATLARI VE TEZGAH SAYISI İSTEĞE
GÖRE BELİRLENEBİLİR.

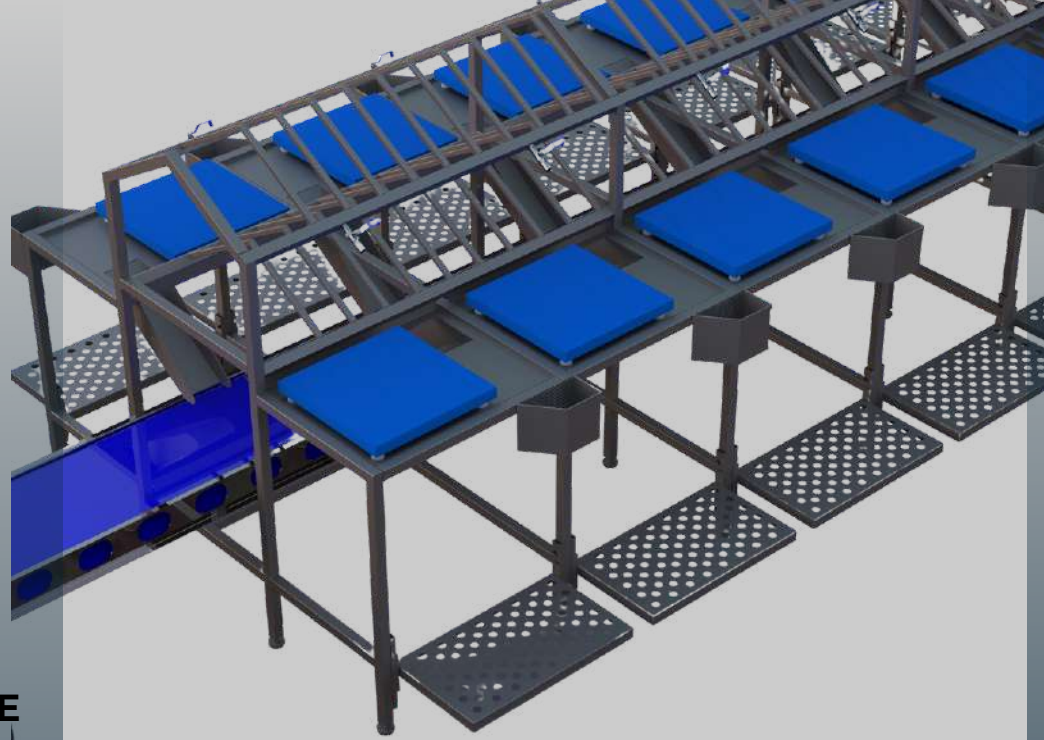

✓ TÜM YÜZEYLER ANSI 304 PASLANMAZ
ÇELİK

✓ HER TEZGAHA TEMİZ SU HATTI

✓ AYARLANABİLİR BASAMAK YÜKSEKLİĞİ

✓ KESME TABLASI

✓ OPSİYONEL OLARAK ATIK YOLLAMA
KONVEYÖRÜ.

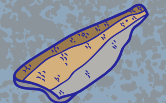
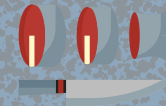

HD-M-LABEL-01

MANUAL TARTIM VE ETİKETLEME MAKİNASI



- TÜM YÜZEYLER PASLANMAZ ÇELİK
- HİJYENİK TASARIM
- IP 67 KORUMA SINIFINA SAHİP
- YÜKSEK KALİTE
- TÜM DİLLERDE ETİKET TASARIMI
- YERLİ ÜRETİM\YERLİ MARKA

HD-M-LABEL-01 ÜRETİM ALANLARINDA HAT ÜZERİNDEN KUTU KASA, STARFOR İLE GELEN ÜRÜNLERİ TARTARAK ETİKET ÇIKTISI VEREN ENDÜSTRİYEL TARTIM MAKİNESİDİR.

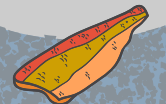

GENEL ÖZELLİKLER



- ✓ 10" Dokunmatik Panel Bejir
- ✓ Ekran çözünürlüğü 1024x600 pixel
- ✓ Cpu ARM Cortex A8 600MHz
- ✓ Endüstriyel Barkod yazıcı
- ✓ Direkt termal veya termal transferbaskı metodu
- ✓ Baskı genişliği 25-104mm
- ✓ Baskı uzunluğu 4mm-2540mm
- ✓ Çalışma ortam sıcaklığı 5 °C -40 °C
- ✓ HMI kontrol Sistemi
- ✓ Basit Raporlama
- ✓ Platform ölçüsü 500mmx600mm
- ✓ Tüm yüzeyler ANSI 304 paslanmaz çelik
- ✓ Yıkanabilme IP 67
- ✓ CE standartlarına uygun
- ✓ Zorlu çalışma şartlarına uygun



- ✓ Rusca Etiket
- ✓ İngilizce Etiket
- ✓ Değişken Datalar
- ✓ hdControl uygulaması üzerinden ÜrünListeleme ve Rapor Takibi
- ✓ En büyük özelliğimiz üretimimize göreyazılımda değişiklikler



HD-M-LABELECO-01

Manuel Tartım ve Etiketleme Makinası

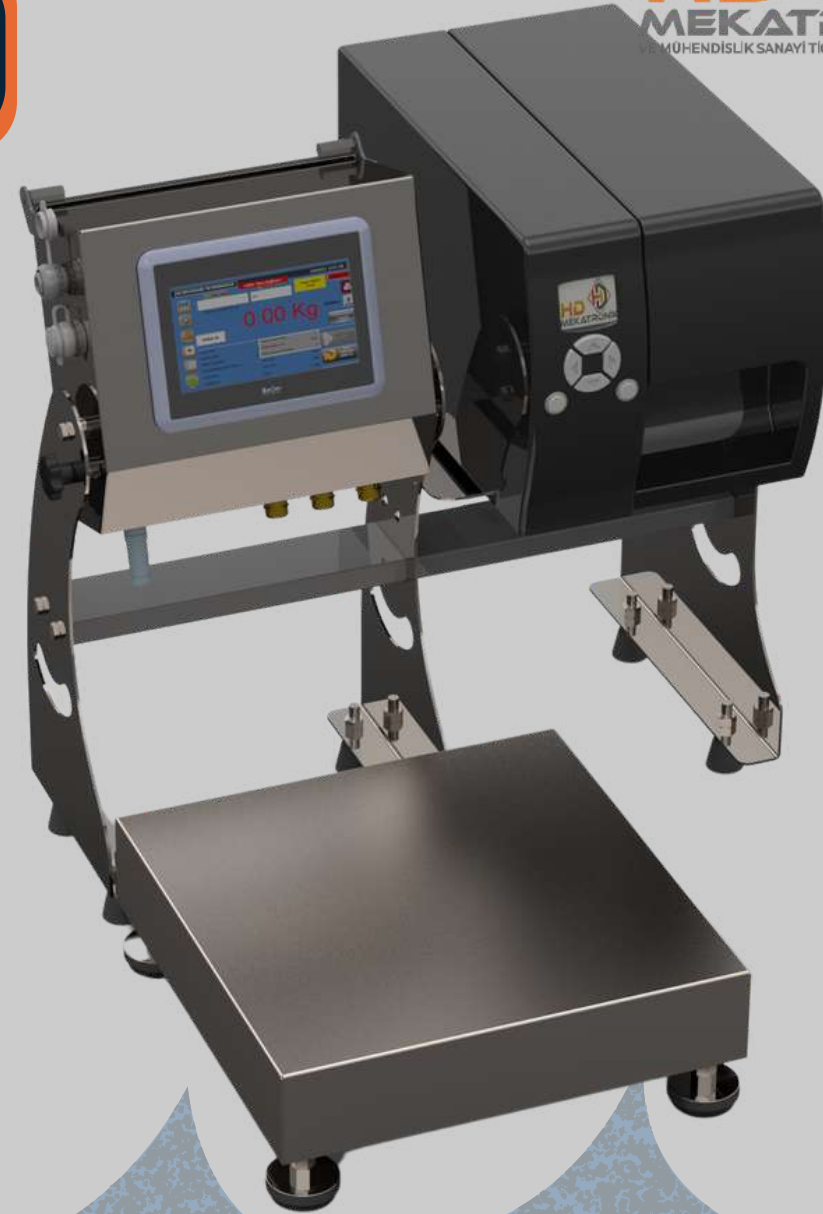

- TÜM YÜZEYLER PASLANMAZ ÇELİK
- HİJYENİK TASARIM
- YÜKSEK KALİTE
- TÜM DİLLERDE ETİKET TASARIMI
- KOLAY TAŞINABİLİR YAPI



'TAŞINABİLİR YAPI SAYESİNDE
KOLAY ÇÖZÜMLER'

HD-M-LABELECO-01 ÜRETİM ALANLARINDA HAT ÜZERİNDEN KUTU, KASA VE STRAFOR İÇİNDE GELEN ÜRÜNLERİN TARTIMIYLA ETİKET ÇIKIŞI SAĞLAYAN ENDÜSTRİYEL TARTIM MAKİNASIDIR.

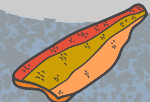



GENEL ÖZELLİKLER

- ✓ 7" Dokunmatik Panel Beijer
- ✓ Ekran çözünürlüğü 1024x600 piksel
- ✓ Cpu ARM Cortex A8 600MHz
- Endüstriyel Barkod yazıcı
- ✓ Direkt termal veya termal transfer baskı yöntemi
- ✓ Baskı genişliği 25-104 mm
- Baskı uzunluğu 4mm-2540mm
- ✓Çalışma ortam sıcaklığı5 °C -40 °C
- ✓HMI kontrol sistemi
- ✓ Basit Raporlama
- ✓ TÜM YÜZEYLER ANSİ 304 paslanmaz çelik
- ✓ CE standartlarına uygundur
- ✓ Zorlu çalışma koşullarına uygun



- ✓ Rusce Etiket
- ✓ İngilizce Etiket
- ✓ Değişken Datalar
- ✓ hdControl uygulaması üzerinden Ürün Listeleme ve Rapor Takibi
- ✓ En büyük özelliğimiz üretimimize göre yazılımın değişmesidir.

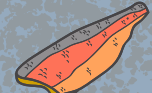

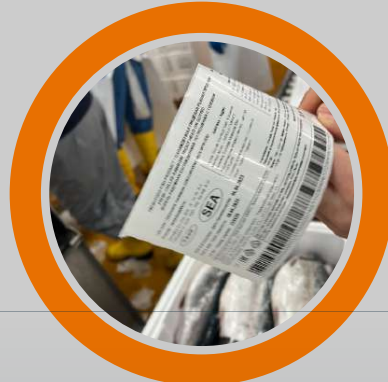

GELİŞMİŞ UYGULAMALAR

- ✓ Akıllı barkod etiketleri
- ✓ Data toplama ve SQL seviyesinde dosya transferi
- ✓ hdControl ile istatistiksel kalite kontrolü
- ✓ Kontrol ve sınıflandırma terazileri
- ✓ Sistemdeki tüm terazileri tek noktadan takip edebilme

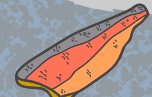
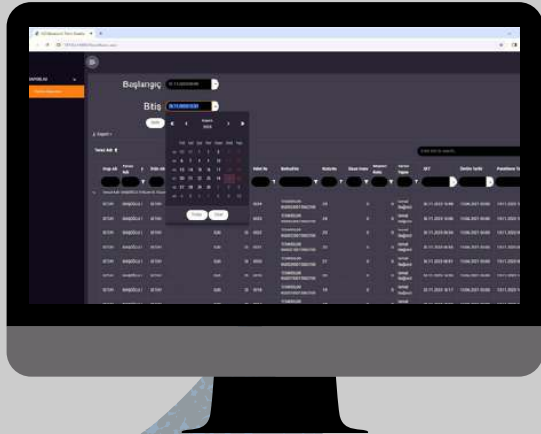
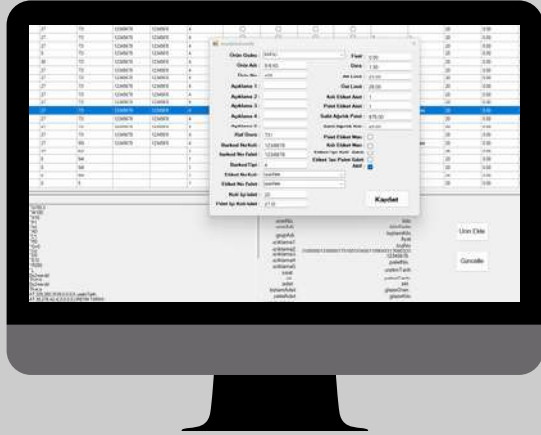

HD-CASEWASH-01 KASA YIKAMA MAKİNESİ

- TÜM YÜZEYLER PASLANMAZ ÇELİK
- HIZ KONTROLLÜ TAŞIYICI SİSTEM
- SPREY NOZULLU BASINÇLI YIKAMA
- DEĞİŞKEN KASA EBATLARI
- FİLTRELEME
- YÜKSEK KALİTE
- YERLİ ÜRETİM\YERLİ MARKA



HD CASEWASH-01 ÜRETİM ALANLARINDA KULLANILAN KİRLİ KASA, KOVA VB. ÜRÜNLERİN YÜKSEK HIZ VE SU VERİMLİLİĞİ İLE TEMİZLEYEN MAKİNADIR.



GENEL ÖZELLİKLER

- ✓ PLC KONTROL
 - ✓ KASA KİRLİLİĞİNE GÖRE HIZ AYARI
 - ✓ ÖN YIKAMA, YIKAMA, DURULAMA
 - ✓ HMI KONTROL SİSTEMİ
 - ✓ AYARLANABİLİR SU SICAKLIĞI
 - ✓ BUHARLI VEYA ELEKTRİKLİ ISITMA SEÇENEĞİ
 - ✓ TÜNEL ÖLÇÜLERİ 350mm x 550mm
 - ✓ POMPA : 5,5 kW (3-4 bar - 400 l/min)
 - ✓ DEĞİŞTİRİLEBİLİR FİLTRE SİSTEMİ
 - ✓ KURUTMA FANI VE KURUTMA SİSTEMİ
- MÜŞTERİ TALEBİNE GÖRE OPSİYONEL OLARAK SUNULMAKTADIR.



- ✓ SAATTE 600 KASA YIKAMA KAPASİTESİ
- ✓ 400L SU TANKI
- ✓ KASA EBATLARINA GÖRE AYARLANABİLEN SİPERLİK VE EMNİYET BARLARI



HD

MEKATRONİK

VE MÜHENDİSLİK SANAYİ TİCARET LİMİTED ŞİRKETİ



"İHTİYAÇLARINIZA HD ÇÖZÜMLER SUNAR"



HD
MEKATRONİK
VE MÜHENDİSLİK SANAYİ TİCARET LİMİTED ŞİRKETİ



Adres:

Subaşı Mahallesi Bakü Sokak No:14
Turgutlu/MANİSA



huzeyfe.yurt@hdmekatronik.com



+90 553 505 68 35

