



Girişim Makina

Gıda İşleme ve Paketleme Makinaları
Food Processing and Packaging Machinery



Paketleme çözümlerimizle dünyanın her yerindeyiz.

Packaging solutions anywhere and everywhere in the world.

Yatay Paketleme Makinaları (Flowpack)
Horizontal Packaging Machinery (Flowpack)

Zarf Tipi Paketleme Makinaları
Overwrapping Packaging Machines

Bisküvi Paketleme Makinaları
Biscuit Packaging Machines

Stick Dolum Makinaları
Stick Filling Machines

Dikey Paketleme Makinaları
Vertical Packaging Machines

Dolum ve Paketleme Makinaları
Filling and Packaging Machines

Termoform Paketleme Makinaları
Thermoforming Packaging Machinery

Otomasyon Ürün Besleme Sistemleri
Automated Product Feeding Systems

Bisküvi Kremalama Makinaları
Biscuit Cream - Sandwiching Machines

Ürün Kataloğu

Product Catalogue

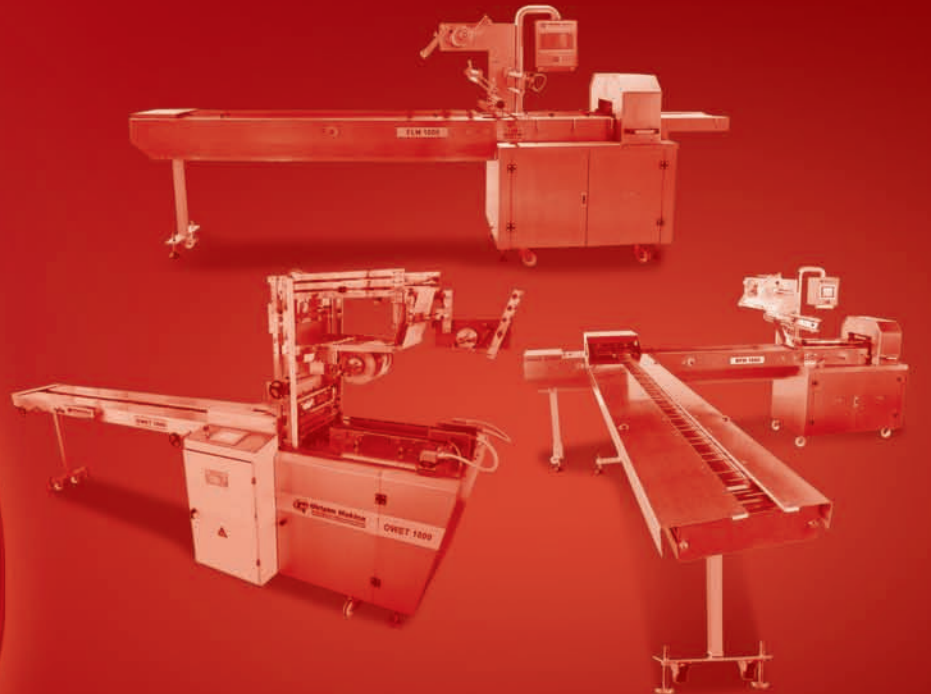

Misyon / Mission (Why we exist?)

Teknolojik değişim ve yenilikleri takip ederek, sürekli gelişim ve mükemmeliyeti temel olarak, yüksek kalite standartlarında paketleme makinaları üretimi yapmak, her zaman ve her yerde müşterilerimize en uygun, en kaliteli, en ekonomik ve en doğru ürünleri sunmaktır.

We, Girisim Packaging Machinery, produce packaging machineries in the most superior quality standards and offer our customers the most convenient, most economical and most accurate products with the highest quality by following and implementing the technological changes and innovations and taking continuous improvement and excellence as basis.

Vizyon / Vision (Our main target)

Ürettiğimiz paketleme makinaları ve geliştirdiğimiz paketleme çözüm önerileriyle müşterilerimizi hedeflerine taşıyan en doğru adres olmak ve paketleme makinaları alanında yerel ve global pazarlardaki mevcut öncü pozisyonumuzu devam ettirmektir.

To be the right address for our clients by enabling them to accomplish their targets with the packaging machines that we produce and packaging solutions that we develop and to maintain our current leading position in the local and global markets in the packaging machinery industry.

Değerlerimiz / Our Values

- Müşteri odaklıyız, müşteri ilişkilerimizde yüksek memnuniyet yaratmayı hedefleriz.
- Üretimde kaliteye önem verir, müşterilerimize ürünlerimizde kusursuz bir deneyim yaşatmayı hedefleriz.
- Adil rekabet eder, dürüstlükten ve ahlak ilkelerinden taviz vermeziz.
- Ekip çalışmasına önem verir, ekip çalışmasının yarattığı takım ruhu ve sinerjiyle daha büyük işler başaracağımızı biliriz.
- Girişimci ruhumuzla inisiyatif ve sorumluluk alırız.
- Yenilikçiyiz, değişimleri takip eder, her türlü koşula çabuk adaptasyon sağlarız.
- We are customer-driven. We aim to create high level of satisfaction in our customer relations.
- We place emphasis on quality in production and aim to give our customers a seamless experience with our products.
- We compete fairly. We do not compromise on the principles of honesty and ethics.
- We place emphasis on teamwork. We know that we can accomplish great things with our team spirit and the synergy created by teamwork.
- We take initiative and responsibility with our entrepreneurial spirit.
- We are innovative. We follow changes and ensure rapid adaptation to all kinds of conditions.

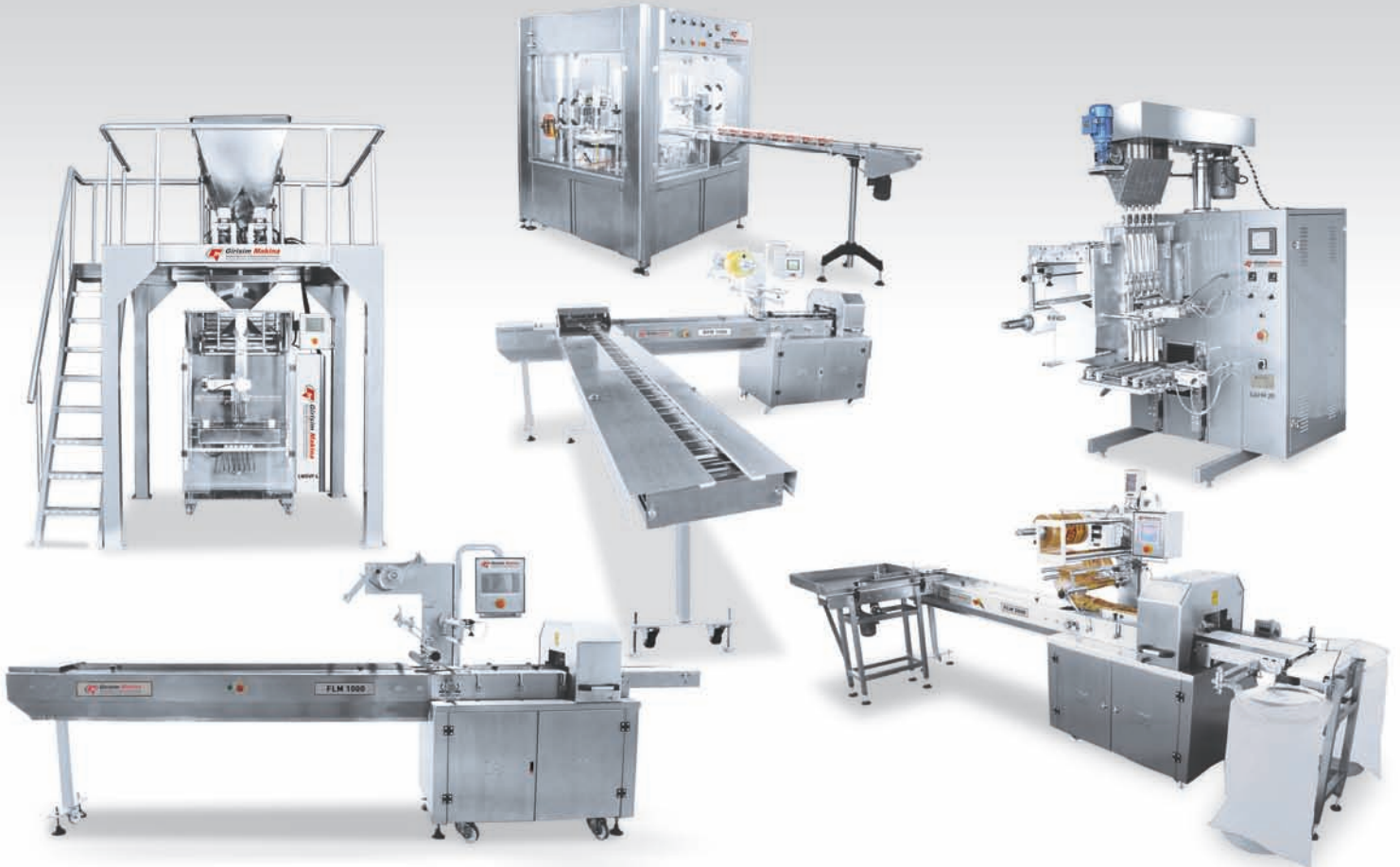



Hakkımızda / About Us

2001 yılında kurulan Girişim Makina yüksek kalite standartlarında paketleme makinaları üretimi ve satışı yapmaktadır. Girişim Makina yatay flow-pack ambalaj makinaları, zarf tipi ambalaj makinaları, bisküvi ambalaj makinaları, yatay paketleme (likit dolum) makinaları, stick dolum makinaları, volumetrik (hacimsel) sistem, vidalı sistem, lineer terazili, multihead çok terazili dikey paketleme makinaları, toz dolum makinaları, sıvı dolum makinaları, thermoform ambalaj makinaları, bisküvi kremalama makinaları, pudra şekeri değirmeni üretimi yapmaktadır. Girişim Makina, paketleme proseslerinde otomatik ürün besleme sistemleri talep edilmesi halinde müşteriye özel projeleriyle otomasyon besleme sistemlerinin uygulamasını yapar ve üretim hattıyla paketleme makinalarının senkronize edilerek daha yüksek kapasitelerde çalışmasını sağlar.

Girişim Makina, paketleme makinaları sektöründe çok geniş ürün portföyüne sahip, teknolojik gelişmeleri üretim süreçlerine yansıtabilen, standart makinalarının yanısıra müşteri talebine özel makina üretebilme yeterliliğine sahip, paketlemeyle ilgili her türlü sorunuza profesyonel ekibiyle birlikte çözüm üretebilecek sektördeki ender firmalardan birisidir. Girişim Makina olarak üretilen makinaların %90 oranında yurtdışı pazarlara satışının yapılması ve bugüne kadar 36 ülkeye ihracatın gerçekleştirilmiş olması bu özenli çalışmanın bir sonucudur. Tüm paketleme makinalarımız, minimum elemanla çalışma ve yüksek hızlarda maksimum performans alınması amacıyla tasarlanarak üretilmektedir.

Zengin ve yüksek teknolojiyle donatılmış CNC tezgahların bulunduğu makina parkuru, kısa süreli esnek teslimat süresi, yüksek üretim kalitesi, eğitilmiş ve deneyimli teknik personeli, müşteri taleplerini dikkate alarak sürekli yürüttüğü Ar-Ge çalışmalarıyla Girişim Makina "Paketlemede Çözüm Ortağınız" olma noktasında bir dünya markasıdır ve on yılı aşkın tecrübesiyle siz değerli müşterilerinize hizmet etmenin haklı gururunu yaşamaktadır. Unutmayın ki, iyi tasarlanmış bir ambalaj ve iyi paketlenmiş bir ürün satışlarınızın artmasında önemli bir etkiye sahiptir.

Girişim Makina sunduğu hızlı ve esnek satış sonrası hizmetlerle de müşterilerine farkını hissettirmekte ve her aşamada tam müşteri memnuniyetini sağlamayı amaçlamaktadır. Satış sonrası kurulum teknik ekibimiz tarafından yapılmakta ve operatör eğitimleri firmamız tarafından kurulum esnasında ücretsiz olarak verilmektedir. Ürünlerimiz 1 yıl, ürünlerimizde kullanılan elektronik malzemeler 2 yıl süreyle garanti kapsamındadır. Ayrıca ürünlerimiz için minimum 10 yıl süreyle yedek parça temini mümkündür.

Girişim Packaging Machinery, established in 2001, performs the production and sale of packaging machines in the high quality standards. Girişim Packaging Machinery produces horizontal flow pack packaging machines, over wrapping (envelope-type) packaging machines, biscuit packaging machines, horizontal filling and packaging machines, stick filling machines, volumetric (volume) system, screw system, linear balanced, multihead multi-balanced vertical packaging machines, powder products filling machines, liquid filling machines, thermoform packaging machines, biscuit cream sandwiching machines and powdered sugar mill. Girişim Packaging Machinery also implements automated feeding systems in the packaging processes with customer specific projects when requested and ensures that the packaging machines perform in high capacities in synchronization with the production line.

Girişim Packaging Machinery is one of the rare companies within the packaging machinery industry that has such a wide portfolio of products, has an ability to reflect technological developments to production processes, has the capability of producing tailor-made products upon the customer's request in addition to the standard machines and has the potential to offer alternative solution ways in respect to packaging matters with its professional team. Exportation of 90% of the production and the execution of continuous exports to 36 countries to date are the results of this conscientious work maintained by Girişim Packaging Machinery. All our packaging machines are designed and manufactured for the purpose of receiving the maximum performance in high-speed and working with the minimum number of staff.

Girişim Packaging Machinery is accepted as "Solution Partner in Packaging Machinery" in a wide geographical area and

Girişim Machinery is, now, at such a point to become a global brand in consequence of the ongoing investments equipped with high technology including CNC machines, flexible and short delivery times, high production quality, well-trained and experienced technical staff and R&D activities carried out in relationship with the customers by taking their demands into account. Girişim Machinery is proud to be serving its valuable customers with more than ten years of experience. Do not forget that a well-designed package and a well-packaged product have a significant effect in increasing your sales.

Girişim Machinery also shows its difference to customers with its flexible and rapid after-sales service offered to customers and aims to provide ultimate customer satisfaction at every stage. Free installation of the machinery is made by our technical staff and operator training during installation is given free of charge. Our products are under 1-year warranty and the electronic materials used in our products are under 2-year warranty. Supply of spare parts for our products is available for minimum 10 years.



Yüksek Kalitede Üretim & Geniş Ürün Çeşitliliği
High Quality Production & Wide Range of Products



Uluslararası İş Tecrübesi (36 ülkeye ihracat)
International Business Experience (export to 36 countries worldwide)



Müşteriye Özel Çözümler & Esnek Teslimat Süreleri
Customer-Oriented Solutions & Flexible Delivery Times



Tüm İşçilik ve Malzeme Hatalarına Karşı 1 Yıl Garanti.
1-Year Warranty against Defects In Workmanship and Materials



Her An Hizmete Hazır Satış Sonrası Teknik Servis Desteği
Technical Service Support-After-Sale at Anytime



Ücretsiz Kurulum Hizmetleri ve Operatör Eğitimleri
Installation Services and Operator Training - Free of Charge

FLM 1000

Yatay Flowpack Paketleme Makinası
Horizontal Flowpack Packaging Machine

Machine D'emballage Horizontale Flowpack

Автоматическая горизонтальная упаковочная машина Флоупак

أفقي آلة التعبئة والتغليف

Kapasite: 200 paket/dk
Capacity: 200 package/min

Opsiyonel /Optional

- Tarih Basma Ünitesi / Date Printing Unit
- Gaz Püskürtme Ünitesi / Gas Injection Unit
- Çıkış Bandı Ürün Sayma / Output Band Packaged Product Counter
- Askı Deliği / Hanger Hole Punch Device
- Çift Bobin / Double Bobbin System
- Körüklü Paket Yapma Aparatı / Gusset-Type Package Making Equipment

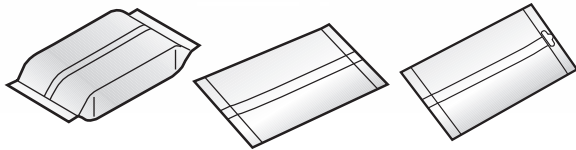
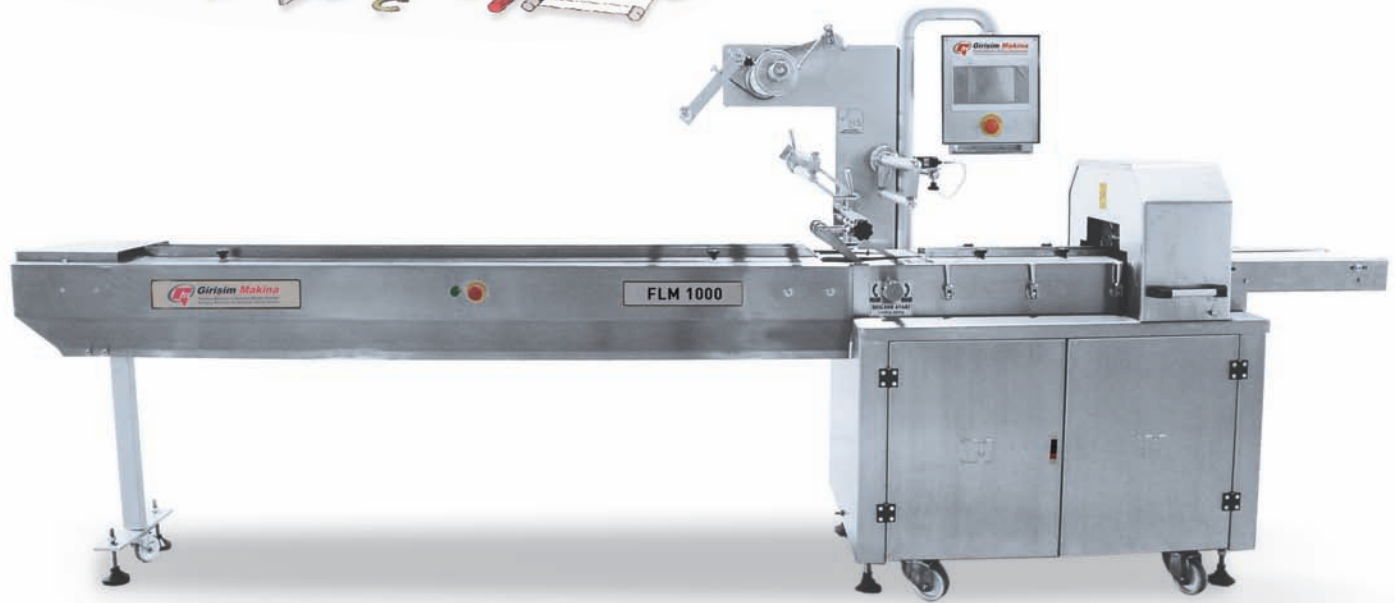
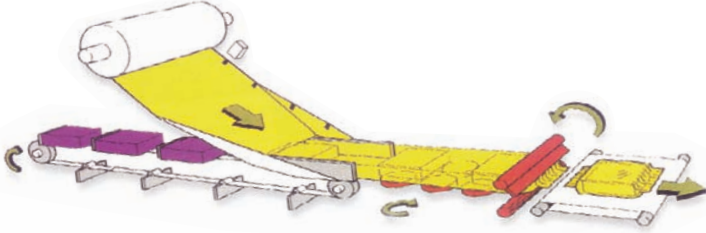

Her türlü ürün ölçünüze göre özel makina dizaynı yapılır.
Special packaging machine design can be done according to all kinds of product size.



Yatay Flow-Pack Paketleme Makinası ile tekli ve ya blok tipteki ürünlerin veya bir kap içerisine konulmuş her türlü ürünün paketlenmesi dokunmatik ekranlı PLC kontrol sistemiyle hızlı ve seri bir şekilde yapılmaktadır. Çay seti ya da setleme dediğimiz ürünler, tekli bisküvi, tablet çikolata ve ya çikolatalı barlar, gofret, cezerye, lokum, kek, ekmekek çeşitleri, hamburger, poğaca, simit v.b. unlu mamüller, helva (80 gr.'dan 1 kg.'a kadar), milföy hamuru, donmuş gıda ürünleri (balık, pizza vb.) tekli sabun, temizlik bezleri ve süngerler, mobilya, araba aksesuarları, yedek parçalar, elektrik malzemeleri, oyuncak, hediyelik eşya, sargı bezi v.b. medikal malzemeler ve yatay olarak sarılabilir her türden özel eşya paketlenilecek ürün örnekleridir. Sıcak ve soğuk yapıştırılmalarda kullanılan baskılı baskısız ambalaj malzemeleri ile çalışabilir. (OPP, BOPP, CPP, polipropilen, alüminyum folyo, alüminyum ve kağıt laminasyonları v.b.)

Horizontal Flow-Pack Packing Machine realizes the packaging of all kinds of single products or block-type products or products placed in a container rapidly and serially by commanding the packaging process with the PLC electronic control system through the touch-screen panel. Tea set packages (including spoon, tea pack and sugar), single biscuit, tablet chocolate or chocolate bars, wafers, sweets, Turkish delight, cakes, hamburger, pastry, bagels, any kind of bread and other bakery products, halva (from 80 gr. to 1 kg.), puff pastry dough, frozen food products (fish, pizza, etc.), single soap, cleaning cloths and sponges, furniture accessories, car accessories, spare parts, electrical components, toy, gift, roll bandage and other similar medical supplies and all kinds of materials that can be wrapped horizontally are examples of products that can be packaged with this machine. The machine works with printed and unprinted packaging materials used in hot or cold sealing such as OPP, BOPP, CPP, polypropylene, aluminum foil, aluminium and paper laminations, etc.

Machine d'ensachage et d'emballage de produits de boulangerie Flowpack
Горизонтальная Машина для Упаковки и
Укладывания в мешки хлебобулочных изделий
الخبز رول التعبئة والتغليف والتغليف ماكينة

Roll Ekmek Paketleme ve Torbalama Makinası
Bread Roll Packaging and Bagging Machine

FLM 2000



Kapasite: 200 adet/dk
Capacity: 200 pcs/min

- Fotoselli fotoselsiz çalışabilme
Ability to work with or without photocell
- PLC elektronik kontrol sistemi
PLC electronic control system
- 5.7 inch dokunmatik ekran
5.7 inch touch screen
- PID ısı kontrolü
PID heat control
- Dijital Sayıcı (opsiyonel)
Digital Counter (optional)
- Tarih Basma Ünitesi (opsiyonel)
Date Printing Unit (optional)
- Komple 304 kalite Cr-Ni paslanmaz
Complete AISI 304 Cr-Ni stainless
steel surfaces

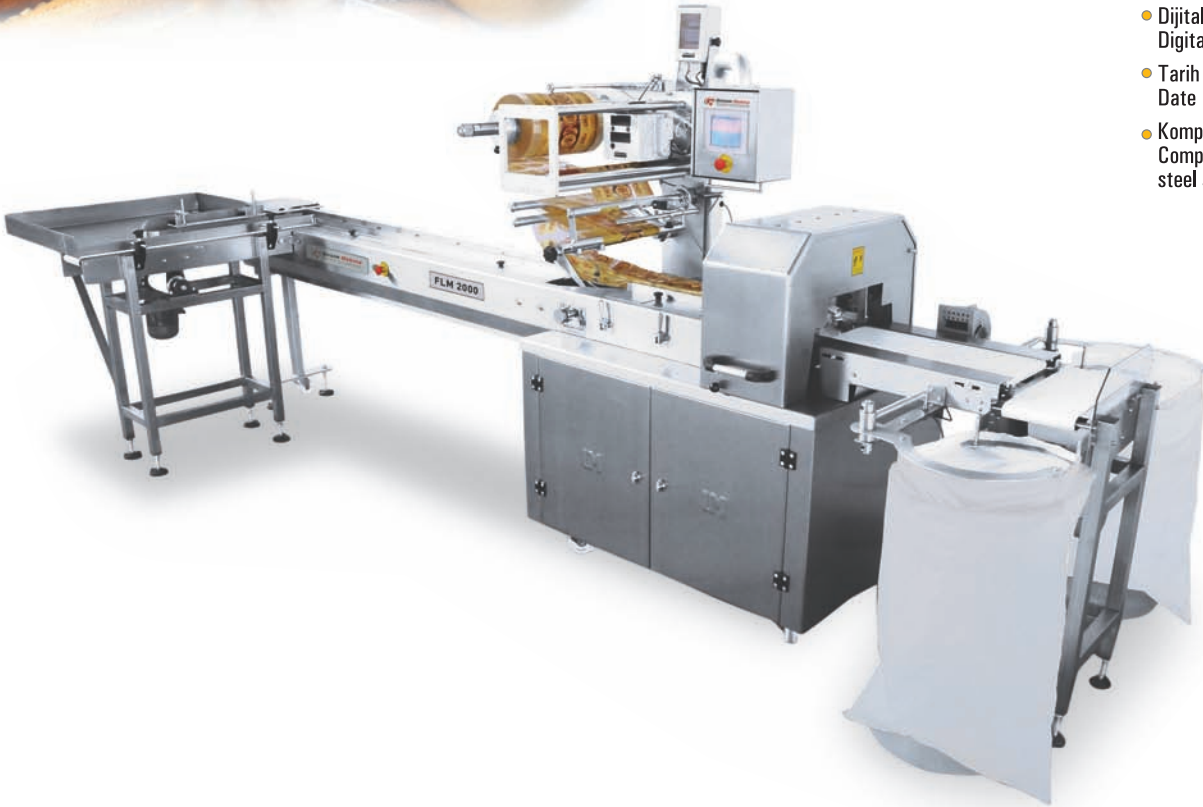

FLM 2000 Paketleme Makinası, roll ekmek, sandviç, hamburger diğer unlu mamül ürünlerin paketlemesini yapar. Tavalı ya da döner tepsili olarak dizayn edilebilen besleme ünitesi iptal edilerek sadece transport vasıtasıyla 300 grama kadar olan daha büyük ekmeklerin paketlenmesini gerçekleştirebilir. Hem düşük gramajlı roll ekmeğin hem de yüksek gramajlı 300 gram ekmeğin aynı makinada paketlenmesi durumunda roll ekmekte paketleme kapasitesi düşecektir. Bu nedenle, yüksek üretim kapasitesiyle çalışan işletmeler için en doğru karar düşük ve yüksek gramajlı ürünler için ayrı ayrı makinaların tercih edilmesidir. Çıkış bandı ünitesinde sağ ve sol tarafta yer alan torbalama sistemi sayesinde ve sayıcı yardımıyla istenilen adette ürünün torbalara dolumu gerçekleştirilmektedir. Ürün gelmediği durumda sayıcı boş paketi saymamakta sayıcı tarafından sadece dolu ürünlerin sayısı yapılmaktadır.

FLM 2000 Horizontal Packaging Machine is used for the packaging of bread roll, sandwich, hamburger and other similar bakery products. The feeding unit can be designed as pan or rotating tray. The packaging of bigger bakery products such as breads up to 300 grams is realized only through the transporter by canceling the feeding unit. The capacity for the packaging of bread roll decreases in the event of packaging of low-weight bread roll and high-weight bread of 300 grams in the same machine. Therefore, the most accurate decision for the companies working with a high production capacity is to purchase separate machines for low-weight and heavy products. It is possible to perform the filling of the packaged products into the bags at the desired amounts with the help of the counter and the bagging system located on the right and left of the output band unit. If there is no product, the counter does not count the empty package. Only the filled packages are counted by the counter.

FLM 3000

PVC Bantlı Yatay Paketleme Makinası
Horizontal Flow Pack Packaging Machine
with PVC Band Feeding

Machine d'emballage Horizontale a bande PVC Flowpack
упаковочная машина с системой подачи ленточного конвейера ПВХ
لماكينه تغليف أفقي بشرط بي في سي

Kapasite: 300 paket/dk
Capacity: 300 package/min

Opsiyonel /Optional

- Tarih Basma Ünitesi / Date Printing Unit
- Gaz Püskürtme Ünitesi / Gas Injection Unit
- Çıkış Bandı Ürün Sayma / Output Band Packaged Product Counter
- Askı Deliği/ Hanger Hole Punch Device
- Çift Bobin / Double Bobbin System
- Körüklü Paket Yapma Aparatı / Gusset-Type Package Making Equipment



Üretim hattından teke düşürülmüş sıralı halde gelen kek, çikolata, gofret, sabun, v.b. ürünler PVC konveyör bant yardımıyla paketleme makinasına iletilir ve ürünün paketlenmesi sağlanır. PVC konveyör bant ile paketleme makinası senkronize çalışmaktadır. Üretim hattından gelen ürünlerin çoklu ya da dağınık bir şekilde gelmesi durumunda talebe özel olarak projelendirme yapılır, ürün akışı teke düşürülür ve PVC konveyör bant aracılığıyla paketlenmek üzere paketleme makinasının transportuna iletilir.

Products such as cake, chocolate, wafer and soap reduced to single line on the production line are transmitted to the packaging machine with the PVC conveyor belt and the packaging of the products is realized. PVC conveyor belt and the packaging machine work synchronized. In the event that the products from the production line come in multiple or dispersed forms, tailor-made project is made according to customer's demand, product flow is reduced to one line and then the product is transferred to the transporter of the packaging machine via the PVC conveyor belt to be packed.

Horizontal Flowpack Packaging Machines

Machine d'emballage Horizontale a magazine Flowpack
Горизонтальная упаковочная машина с загрузчиками продукта
فلوباك تغليف أفقي ماكينة مع أنظمة التغذية مجلة

Magazınlı Yatay Flowpack Paketleme Makinası
Horizontal Flow Pack Packaging Machine with
Magazine Feeding System

FLM 4000

Kapasite: 200 paket/dk
Capacity: 200 package/min



Magazın beslemeli sistemler; bisküvi, kraker v.b. düz ürünlerin beslemesini kolaylaştırarak yarı otomatik besleme imkanı sağlayan çözümlerdir. Ürün ölçüleri ve istenilen paket şekli göz önünde bulundurularak farklı magazın besleme sistemleri uygulanabilir.

Magazine feeding systems are solutions providing semi-automatic feeding that facilitates the feeding of plain products such as biscuits, crackers and other similar products. Different magazine feeding systems can be applied by taking the product dimensions and shape of the desired package into account.

Machine d'emballage Horizontale a rouleau inverse inferieur
Горизонтальная упаковочная машина с нижней подачей пленки
عكسي تغليف أفقي آلة

Altın Sarmalı Ters Yatay Paketleme Makinası
Bottom Wrapped Reverse Horizontal Flow Pack Packing Machine

FLM 5000

Kapasite: 200 paket/dk
Capacity: 200 package/min



Düzensiz şekilli olmayan ve ya çok tanecikli ürünleri yatay olarak alttan sararak paketleme yapmaktadır. Meyve, sebze, canlı balık, sargı bezi v.b ürünlerin paketlenmesinde tercih edilir.

Irregular shaped products or multi-grain products can be packaged horizontally by wrapping from the bottom side. It is preferred for the packaging of products such as fruits, vegetables, live fish, roll bandage etc.

BPM 1000

Yandan Beslemeli Bisküvi Paketleme Makinası
Biscuit Packaging Machine with Side Feeding System

Machine d' emballage Horizontale de biscuit a alimentation laterale
Горизонтальная упаковочная машина для упаковки печения на ребре
آلة تغليف البسكويت مع نظام تغذية الجانبية

Kapasite: 200 paket/dk
Capacity: 200 package/min



- Fotoselli fotoselsiz çalışabilme
Ability to work with or without photocell
- PLC elektronik kontrol sistemi
PLC electronic control system
- 5.7 inch dokunmatik ekran
5.7 inch touch screen
- PID ısı kontrolü
PID heat control
- Komple 304 kalite Cr-Ni paslanmaz çelik yüzeyler
Complete AISI 304 Cr-Ni stainless steel surfaces
- Tarih Basma Ünitesi (opsiyonel)
Hanger Hole Punch Device (optional)
- Çift Bobin / Double Bobbin (opsiyonel)
Double Bobbin System (optional)
- Körüklü Paket Yapma Aparatı (opsiyonel)
Gusset-Type Package Making Equipment (optional)

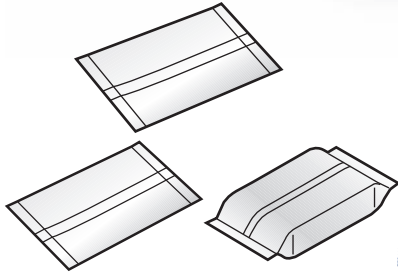

Bisküvi, kraker v.b ürünleri çoklu olarak kulaklı tip paket yapar. Ürünler 90 band üzerinde yer alan çubuklar arasına manuel olarak elle dizilir. Ürünlerin band hareketiyle paketleme makinasına aktarılarak kulaklı tarzda paketlenmesi sağlanır. Müşteri isteğine bağlı olarak üretim hattı, bisküvi kremalama makinası ve bisküvi paketleme makinası senkronize edilerek el değmeden otomatik besleme sistemiyle yüksek kapasitelerde paketleme sağlanabilir.

It packages products such as biscuits, crackers, wafers, etc in the flow pack package type. The products are placed manually to the intervals on the 90 band. The products are transferred to the packaging machine with the band movements and realized to be packed in the flow pack form. Depending on the customer request, the production line, biscuit cream sandwiching machine and biscuit packaging machine can be synchronized all together on the operational phase. With the help of automated feeding systems, it is possible to realize the packaging in higher capacities and receive packaged products in more hygiene conditions without touching by hand.

Machine d'ecremeuse de biscuit

Автоматическая машина для производства сэндвич печенья
بسكویت کریم یقحم آله

Bisküvi Kremalama Makinası Biscuit Cream - Sandwiching Machine

BCSM 1200

Kapasite: 1200 adet/dk
Capacity: 1200 pcs/min



Yuvarlak Bisküviler Round Biscuits	Diameter	
	min.	max.
	32 mm	58 mm

Dört Köşe Bisküviler Foursquare Biscuits	Diameter	
	min.	max.
En / Width	32 mm	50 mm
Boy / Height	32 mm	50 mm

Her türlü ürün ölçünüze göre özel makina dizaynı yapılır.
Special packaging machine design can be done according to all kinds of product size.

Bisküvi kremalama makinası tek sıralı çift kanallı ve ya çift sıralı dört kanallı olarak üretilmektedir. Bisküvi akışı pnömatik vibrasyonlu kanallar aracılığıyla olmaktadır. Hem yuvarlak hem de dört köşe (kare ve ya dikdörtgen) bisküvilerin kremalanmasını sağlar.

Biscuit cream sandwiching machine is produced as single row and dual-channel or double-row and four-channel. The biscuit flow is realized through the pneumatic vibrated channels. The machine allows the cream sandwiching of both round and foursquare (square or rectangular) biscuits.

Moulin de sucre en poudre

Мельница для сахарной пудры
مسحوق السكر مطحنة

Pudra Şekeri Değirmeni Powdered Sugar Mill

PSM 200

Kapasite: 200 Kg/h
Capacity: 200 Kg-hr



Pudra Şekeri Değirmeni gofret ve çikolata da kullanılmak üzere şekeri inceltip pudra haline getiren bir makinadır. Vakum emmeli, elekli ve helozonik aktarmalıdır.30-35 mikron incelikte pudra şekeri elde edilir.

Powdered Sugar Mill is a machine transforming sugar into powder form in order to use powdered sugar on wafers and chocolates. They are vacuum suction, griddled and vortex flowed. Powdered sugar in 30-35 microns can be obtained.

Kremalı ve Kaplamalı Bisküvi Otomatik Besleme ve Paketleme Makinası

Cream and Coated Biscuit Automatic Feeding and Packaging Machine

Machine d'emballage a alimentation et ecremeuse automatique de biscuit

Автоматическая система подачи и упаковки для печенье

التلقائي التغذية والتعبئة والتغليف لملفات تعريف الارتباط

- Kremalı bisküviler için komple entegre kremalama ve paketleme hattı
Complete Automated Solution for Biscuit Creaming and Packaging
- Yüksek hızlı yatay paketleme makinaları
Packaging Machineries in high-speed
- İstifleme sistemi (Paketleme makinası ile doğrudan bağlantılı)
Stacking System directly in connection with packaging machines
- Bisküvi Kremalama Makinaları
Biscuit Cream-Sandwiching Machines
- Gruplama ve Bisküvi dizici sistemi
Biscuit Grouping and Biscuit Stringer System
- Otomasyon Besleme Sistemlerimizle daha az iş gücü gereksinimi,
daha az maliyet, daha yüksek karlılık imkanı
Advantage of less labour requirement, less labour cost and higher profitability
with our automated feeding solutions.



MAGAZİNLİ BESLEME SİSTEMİ
FEEDING SYSTEM WITH MAGAZINE

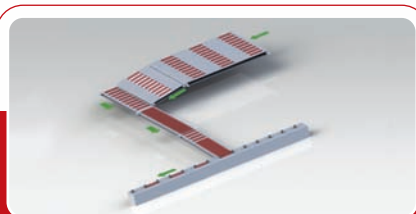

90° BESLEME SİSTEMİ
90° FEEDING SYSTEM

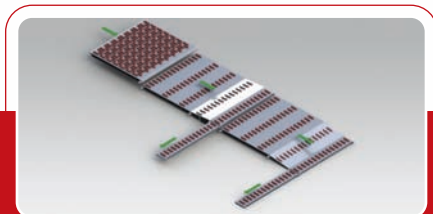

BAR DAĞITIM SİSTEMİ
BAR DISTRIBUTION SYSTEM

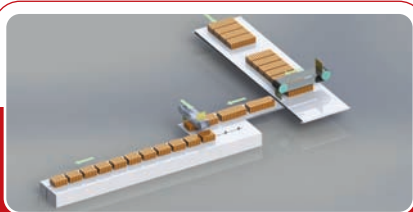

BLOK BESLEME SİSTEMİ
BLOCK FEEDING SYSTEM

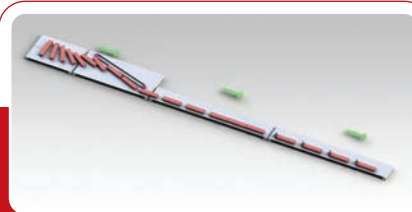

İN-LİNE BESLEME SİSTEMİ
IN-LINE FEEDING SYSTEM

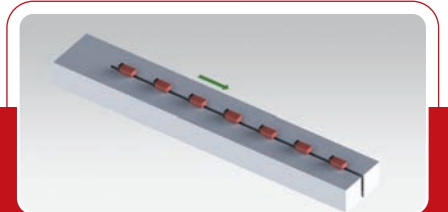

MANUEL BESLEME SİSTEMİ
MANUAL FEEDING SYSTEM

OWET 1000

Zarf Tipi Paketleme Makinası
Over Wrapping Packaging Machine

Machine d'emballage a type d'enveloppe
Оберточная упаковочная машина в упаковку типа конверт
المغلف نوع ماكينة تغليف

Kapasite: 20-50 paket/dk
Capacity: 20-50 package/min

PAKET EBATLARI (mm) - PACKAGE DIMENSIONS (mm)

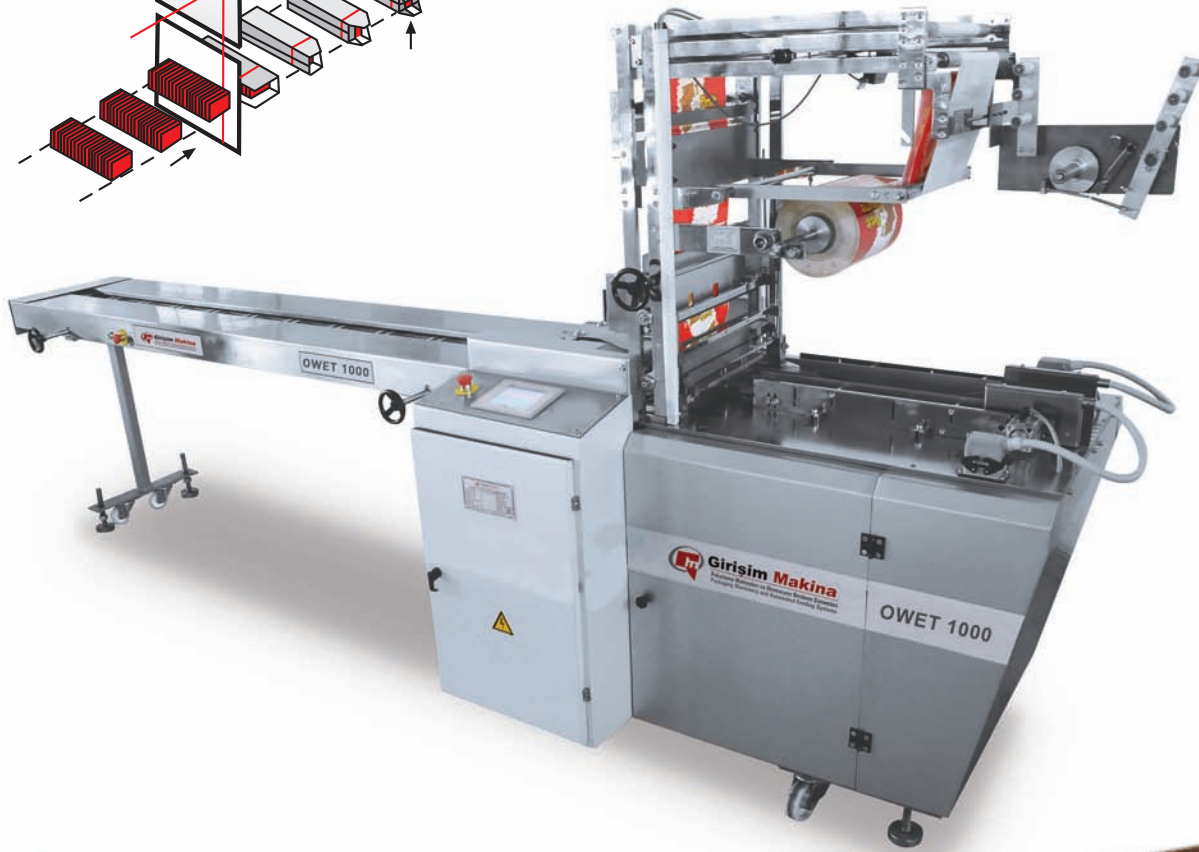
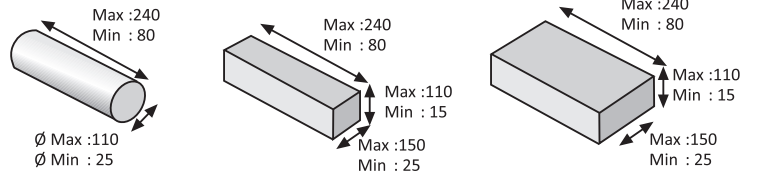
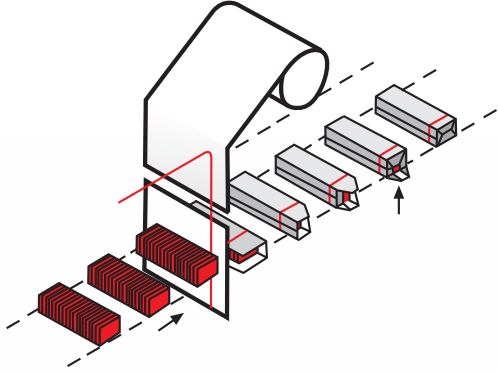

Her türlü ürün ölçünüze göre özel makina dizaynı yapılır.
Special packaging machine design can be done according to all kinds of product size.



Sabun, bisküvi, gofret v.b. ürünleri yuvarlak, dört köşe ve ya oval ürün şekli fark etmeksizin zarf tipi olarak paketlenir. 5'i bir arada 1 kg'lık ekopaketlerin zarf tipi paketlenmesi de bu makinayla mümkündür. Dış ambalaj malzemesinin içine ek bir ambalaj olarak karton uygulaması yapılabilir. Kolay açma bandı ve tarih basma ünitesi opsiyonel olarak ilave edilebilir.

Makes the wrapping of the products such as soap, biscuit, waffles, etc. from the top, realizes the packaging in the envelope-type form and yields round, square or oval packages in shape. It is also possible to make the packaging of 5-in-1 eco-packages with this machine. Carton package application might be placed into the outer packaging material as an additional protection resource. Easy opening band and date printing unit can be installed to the machine as an option depending on the customer's request.

Machine d'emballage de boîte a type d'enveloppe
Оберточная упаковочная машина для упаковки
коробки в упаковку типа конверт
المغلف نوع صندوقية ماكينة تغليف

Zarf Tipi Kutu Paketleme Makinası
Over Wrapping Box Packaging Machine

OWET 2000

PAKET EBATLARI (mm) PACKAGE DIMENSIONS (mm)

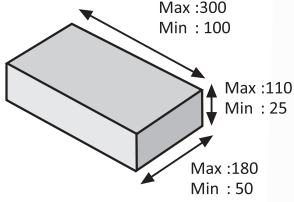

Kapasite: 25-35 paket/dk
Capacity: 25-35 package/min

Her türlü ürün ölçünüze göre özel makina dizaynı yapılır.
Special packaging machine design can be done according to
all kinds of product size.



Gıda, kimya, tütün, temizlik, kozmetik v.b sektörlerde geniş bir alanda tercih edilen üstün sarıp alından yapıştıran zarf tipi paketlemeyi gerçekleştiren ideal kutu paketleme makinasıdır. Kare, dikdörtgen ve ya yuvarlak formattaki her türlü sakız, sabun, lokum, tütün, nargile, çikolata, çay, maya, ilaç, parfüm, kozmetik v.b ürün kutularını yüksek hassasiyetle ve mükemmel şekilde paketler. Kolay açma bandı ve tarih basma ünitesi müşteri talebine göre ilave edilebilir.

It is the ideal over wrapping box-packaging machine to receive the packages in the envelope-type form by wrapping the products from the top and sealing from the bottom. This machine is highly preferred in a broad range of industries such as food, chemical, tobacco, cleaning, cosmetics, etc. It packages the boxes of all kinds of products such as chewing gum, soap, Turkish delight, tobacco, chocolate, tea, yeast, tobacco for shisha, medicine, perfume, cosmetics, etc. in square, rectangular or round format with high precision and in excellence. Easy opening band and date printing unit can be installed to the machine as an option according to customer's request.

LWSVP 4

Linear Sistem 4 Terazili Dikey Paketleme Makinası
Linear Weighing System 4-Scale Vertical Packaging Machine

Kapasite: 8-35 paket/dk
Capacity: 8-35 package/min



Machine d'emballage verticale a system lineaire a 4 tetes
Вертикальная упаковочная машина с линейным весовым дозатором
آلة التغليف العمودي ذات النظام الخطي وأربعة موازين

ÜRÜN GRAMAJI / PRODUCT WEIGHT

Kuruyemiş / Dried Nuts And Fruits : 200 gr. – 1000 gr.
Bakliyat / Legumes : 500 gr. – 5000 gr.
Toz şeker / Granulated Sugar : 500 gr. – 10.000 gr.
Toz deterjan / Powder Detergent : 500 gr. – 10.000 gr.

PAKET TÜRLERİ / PACKAGE TYPES

Yastık / Pillow, Körüklü / Gusset-Type, Oturan Paket / Stand-up, Quadro Paket / Quadro Packages

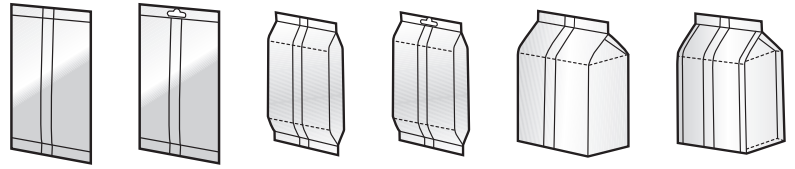

Dolum Sistemi : 4 Terazili Linear Dolum Sistemi

Ürünler: Serbest akıcılık özelliğine sahip taneli-granül (kuruyemiş, dondurulmuş ürünler, mantı, makarna, bisküvi, çikolata, şekerleme v.b.) veya kristalize hale getirilmiş (toz şeker, tuz, v.b) kıvamdaki ürünlerin paketlenmesinde kullanılır.

Filling System: 4 - Scale Linear Filling System

Products: It is used for the packaging of granular products having the feature of free fluidity such as dried nuts, frozen products, ravioli, pasta, biscuits, chocolates, candies or crystallized products such as granulated sugar, salt, powder detergent. Product is filled into the discharging scales through the vibration channels and after the product weight in the discharging scales reaches to the desired amount, the product is discharged from the discharging scales to the packaging part to be packed.

MWSVP 10

Multihead Sistem 10 Terazili Dikey Paketleme Makinası
Multihead Weighing System 10-Scale Vertical Packaging Machine

Kapasite: 25-65 paket/dk
Capacity: 25-65 package/min



Machine d'emballage verticale a Multitete

Вертикальная упаковочная машина с мультиголовочным весовым дозатором
10 رؤوس متعدد الرأس آلة تغليف وازن

ÜRÜN GRAMAJI / PRODUCT WEIGHT:

20 – 1000gr / 1000 – 5000 gr

PAKET TÜRLERİ / PACKAGE TYPES

Yastık / Pillow, Körüklü / Gusset-Type, Oturan Paket / Stand up, Quadro Paket / Quadro Packet

Opsiyonel /Optional

- Barkodlu Tarih basma ünitesi
Date Printing Unit with Barcode Printer
- Askı Deliği Açma Aparatı
Hanger Hole Punch Device
- Körüklü Paket Aparatı
Gusset-Type Package Making Equipment
- Quadro Paket Aparatı
Quadro Package Making Equipment
- Besleme Elevatörü
Feeding Elevator
- Paketleme sonrası ürün çıkış konveyörü
Product output conveyor after packaging



Dolum Sistemi: 10 Terazili Multihead Dolum Sistemi

Ürünler: Kuruyemiş, bakliyat, makarna, şekerleme, draje lokum, çay, toz şeker, cips, bisküvi, gofret, dondurulmuş ürünler, sebze, meyve v.b ürünlerin paketlenmesinde kullanılır.

Filling System: 10-Scale Multihead Filling System

Products: It is used for the packaging of dried nuts and fruits, legumes, pasta, candy, coated Turkish delight, tea, granulated sugar, chips, biscuits, wafers, frozen products, vegetables, fruits, etc.

Machine d'emballage verticale doseuse volumétrique
Вертикальная упаковочная машина с объемным дозатором
آلة التغليف العمودي ذات النظام الحجمي

Volumetrik Sistem Dikey Paketleme Makinası
Volumetric Weighing System Vertical Packing Machine

VSVP 5000

ÜRÜN GRAMAJI / PRODUCT WEIGHT:

500 gr – 5000 gr

PAKET TÜRLERİ / PACKAGE TYPES

Yastık / Pillow, Körüklü / Gusset-Type, Oturan Paket / Stand-up, Quadro Paket / Quadro Packages



Kapasite: 15-50 paket/dk
Capacity: 15-50 package/min

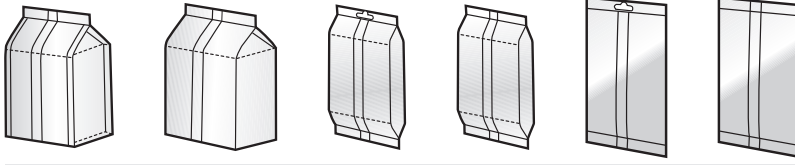

Dolum Sistemi: Volumetrik (Hacimsel) Dolum Sistemi

Ürünler: Fasülye, mercimek, nohut, pirinç, v.b. bakliyat ürünleri; susam, kekik, v.b. taneli baharat ürünleri; ayçekirdeği, fındık, fıstık, v.b. kuruyemiş ürünleri, şekerleme, jelibon, mantı deterjan paketleme v.b ufak tanecikli ürünlerin paketlenmesinde kullanılır.

Filling System: Volumetric Filling System

Products: It is used for the packaging of beans, lentils, chickpeas, rice and other similar legumes; granular spices such as sesame, thyme, etc.; dried nuts and fruit products such as sunflower seeds, hazelnuts, peanuts; candy, jelly beans, ravioli, detergent and small granular products.

Machine d'emballage verticale doseuse volumétrique
Вертикальная упаковочная машина с объемным дозатором
آلة التغليف العمودي ذات النظام الحجمي

Volumetrik Sistem Dikey Paketleme Makinası
Volumetric Weighing System Vertical Packing Machine

VSVP 1000

ÜRÜN GRAMAJI / PRODUCT WEIGHT:

20 – 1000 gr

PAKET TÜRLERİ / PACKAGE TYPES

Yastık / Pillow, Körüklü / Gusset-Type, Oturan Paket / Stand up, Quadro Paket / Quadro Packages

Opsiyonel /Optional

- Tarih Basma Ünitesi / Date Printing Unit with Barcode Printer
- Askı Deliği / Hanger Hole Punch Device
- Körüklü Paket Yapma Aparatı / Gusset-Type Package Making Equipment
- Quadro Paket Aparatı / Quadro Package Making Equipment
- Besleme Elevatörü / Feeding Elevator
- Paketleme sonrası ürün çıkışı / Product output conveyor after packaging



Dolum Sistemi: Volumetrik (Hacimsel) Dolum Sistemi

Ürünler: Fasülye, mercimek, nohut, pirinç, v.b. bakliyat ürünleri; susam, kekik, v.b. taneli baharat ürünleri; ayçekirdeği, fındık, fıstık, v.b. kuruyemiş ürünleri, şekerleme, jelibon, mantı deterjan paketleme v.b ufak tanecikli ürünlerin paketlenmesinde kullanılır.

Filling System: Volumetric Filling System

Products: It is used for the packaging of beans, lentils, chickpeas, rice and other similar legumes; granular spices such as sesame, thyme, etc.; dried nuts and fruit products like sunflower seeds, hazelnuts, peanuts, etc.; candy, jelly beans, ravioli, detergent and small granular products.

Kapasite: 15-50 paket/dk
Capacity: 15-50 package/min



ASVP 1000

Vidalı Sistem Dikey Paketleme Makinası
Auger Weighing System Vertical Packaging Machine

Kapasite: 25-30 paket/dk
Capacity: 25-30 package/min



Machine d'emballage verticale doseur a vis

Вертикальная упаковочная машина со шнековым дозатором
آلة التغليف العمودي ذات النظام البرغي

ÜRÜN GRAMAJI / PRODUCT WEIGHT: 10 gr – 1000 gr

PAKET TÜRLERİ / PACKAGE TYPES

Yastık / Pillow, Körüklü / Gusset-Type, Oturan Paket / Stand-up, Quadro Paket / Quadro Packages



Dolum Sistemi: Vidalı Dolum Sistemi

Ürünler: Pul biber, karabiber, nişasta, un, kahve, krema, pudra şekeri, hindistan cevizi, nane, vanilya, süt tozu, kahve, kimyon, karbonat, katkı maddeleri, toz tarım ilaçları, çimento, alçı, derz dolgu v.b. diğer toz ürünleri ve ince granüllü mamüllerin paketlenmesinde kullanılır.

Filling System: Auger Filling System

Products: It is used for the packaging of products such as flaked red pepper, black pepper, starch, flour, coffee, cream, powdered sugar, coconut, mint, vanilla, milk powder, coffee, cumin, baking soda, additives, pesticides, dust, cement, plaster, grouting and other similar powder products or fine-grained products.

HFM 1000

Yatay Dolu ve Paketleme Makinası
Horizontal Filling and Packaging Machine

Kapasite: 40-80 paket/dk
Capacity: 40-80 package/min



Sachets Machine remplissage et d'emballage horizontale

Горизонтальная фасовочно-упаковочная машина
в трех или четырех-шовных пакеты типа «саше»

أفقي ملء و آلة التعبئة و التغليف

ÜRÜN GRAMAJI / PRODUCT WEIGHT: 1-100 gr

PAKET TÜRLERİ / PACKAGE TYPES:

Üç veya dört kenardan dikişli paketler /
Three or four side seal packages

PAKET ÖLÇÜLERİ / PACKAGE DIMENSION:

40 x 40 mm (min.) 150 x 160 mm (max.)

Opsiyonel /Optional

- Otomatik süreklî besleme için elevatör / Feeding Elevator for continuous feeding
- Paketlenen ürünü sayarak taşıyan konveyör / Conveyor carrying packaged products by counting
- Özel Kalıp Çentik Aparatı / Line Notch Equipment
- Çizgi Çentik Aparatı / Line Notch Apparatus
- Toz Emme Aspiratörü / Dust Suction Aspirator
- Barkodlu Tarih Basma Ünitesi / Date Printing Unit with Barcode Printer



Dolum sistemi: Vidalı, Volumetrik, Lineer, Elektronik Terazı ve ya Likit Dolu Ünitesi

Ürünler: Toz şeker, üçü bir arada kahve, toz içecekler, karabiber, pudra, tarçın, çorba, süt tozu, salep, hamur kabartma tozu gibi toz ürünler, ketçap, mayonez, şampuan, saç kremi, jel, bakım kremi, zeytinyağı gibi sıvı ürünler ve taneli ürünlerin paketlenmesinde kullanılır.

Filling System: Auger, Volumetric, Linear, Electronic Scale or Liquid Filling Unit

Products: It is used for the packaging of powder products such as granulated sugar, three-in-one coffee, powdered drinks, black pepper, powder, cinnamon, soup, milk powder, salep, baking powder; liquid products such as ketchup, mayonnaise, shampoo, hair conditioner, gel, care cream, olive oil and other grain products.

Stick Machine remplissage verticale a system volumetrique
Вертикальная пяти-канальная фасовочно-упаковочная машина в пакеты типа «стик» с объемным дозатором
عمودي ملء و آلة التعبئة و التغليف مع نظام الجرعات الحجمي

Stick 5 Kanallı Volumetrik Sistem Dolum Makinası
Stick-Type 5-Line Volumetric Weighing System Filling Machine

SVFM 20

ÜRÜN GRAMAJI / PRODUCT WEIGHT : 1 gr. – 20 gr.
PAKET BOYU / PACKAGE HEIGHT : 40-150 mm.
PAKET ENİ / PACKAGE WIDTH : İstenen tek sabit ölçü / For only one fixed width

Kapasite: 10-50 paket/dk (Tek Hat)
Capacity: 10-50 package/min (Single Line)



Dolum Sistemi: Volumetrik (Hacimsel)

Ürünler: Tek kullanımlık kahve ve kahve karışımları, toz aromalı içecekler, toz şeker, tuz, baharatlar, v.b. diğer toz, sıvı ve ya granüllü ürünlerin boru ve hacim kapları değiştirilmek suretiyle yüksek hassasiyette paketlenmesini yapan makinadır.

Filling system: Volumetric

Products: It is used for the packaging of disposable coffee and coffee mixes, powdered flavored drinks, sugar, salt, spices, other powder, liquid or granular products in high-precision and in excellence. The tubes and volume containers are required to be changed for each product with different characteristics.

Stick Machine remplissage et d'emballage verticale a system a vis
Вертикальная пяти-канальная фасовочно-упаковочная машина в пакеты типа «стик» со шнековым дозатором
عمودي ملء و آلة التعبئة و التغليف مع نظام الجرعات او جير

Stick 5 Kanallı Vidalı Sistem Dolum Makinası
Stick-Type 5-Line Auger Weighing System Filling Machine

SAFM 20

ÜRÜN GRAMAJI / PRODUCT WEIGHT : 0,5-20 gr.
PAKET BOYU / PACKAGE HEIGHT : 40-150 mm.
PAKET ENİ / PACKAGE WIDTH : İstenen tek sabit ölçü / For only one fixed width

Kapasite: 10-50 paket/dk (Tek Hat)
Capacity: 10-50 package/min (Single Line)

Opsiyonel /Optional

- 2 hatlıdan 10 hatlıya kadar üretilebilir.
Can be produced from 2 lines to 10 lines.
- Tırtıklı ve ya düz boy kesme bıçakları
Serrated or plain cutting blades
- Kolay açma çentiği (opsiyonel)
Easy-open notch (optional)
- Paketleme sonrası çıkış konveyörü (opsiyonel)
Output conveyor after packaging (optional)



Dolum Sistemi: Vida tur sayısı (vidalı)

Ürünler: Tek kullanımlık kahve ve kahve karışımları, toz aromalı içecekler, toz şeker, tuz, baharatlar, v.b. diğer toz, sıvı ve ya granüllü ürünlerin boru ve hacim kapları değiştirilmek suretiyle yüksek hassasiyette paketlenmesini yapan makinadır.

Filling system: Auger Filling System (Number of auger rotation)

Products: It is used for the packaging of disposable coffee and coffee mixes, powdered flavored drinks, sugar, salt, spices, other powder, liquid or granular products in high-precision and in excellence. The tubes and volume containers are required to be changed for each product with different characteristics.

FM C2R

Rotary İkili Çikolata Dolum Makinası
Rotary System 2-Line Chocolate Filling Machine

Kapasite: 2200 kase/saat
Capacity: 2200 bowl / h



ÜRÜN GRAMAJI / PRODUCT WEIGHT: 10 gr. – 1000 gr.

Machine remplissage a double rotation pour chocolat
Машина роторного типа для розлива шоколада и укупорки
الدوارة 2- الخط الشوكولاته ملء و ختم آلة



Makina kaseleri ikili olarak hazneye alır, fotosel kaseleri gördüğü zaman istenilen gramajda çikolata dolumunu yapar, folyo yapıştırılır, kapaklar kase üzerine yerleştirilir, dolumu yapılan ve paketlenen ürünler çıkış konveyör bandına aktarılır. Çikolatanın dışında fındık ezmesi, fıstık ezmesi, salça, tereyağ v.b. kıvamda diğer ürünlerin de dolum, kapama ve paketlemesini yapar.

Machine takes bowls into the hopper in two lines. When bowls are seen by photocell system, the machine makes the filling of chocolate in the desired weight. Foil is sealed, transparent covers are placed on the bowls and packaged products are transferred to the output conveyor belt. In addition to chocolate, products such as peanut butter, hazelnut butter, tomato paste, butter and other similar products are filled, sealed and packaged.

FM L4L

Lineer Dörtlü Krem Peynir Dolum Makinası
Linear System 4-Line Cream Cheese Filling Machine

Kapasite: 4500 kase/saat
Capacity: 4500 bowl/h

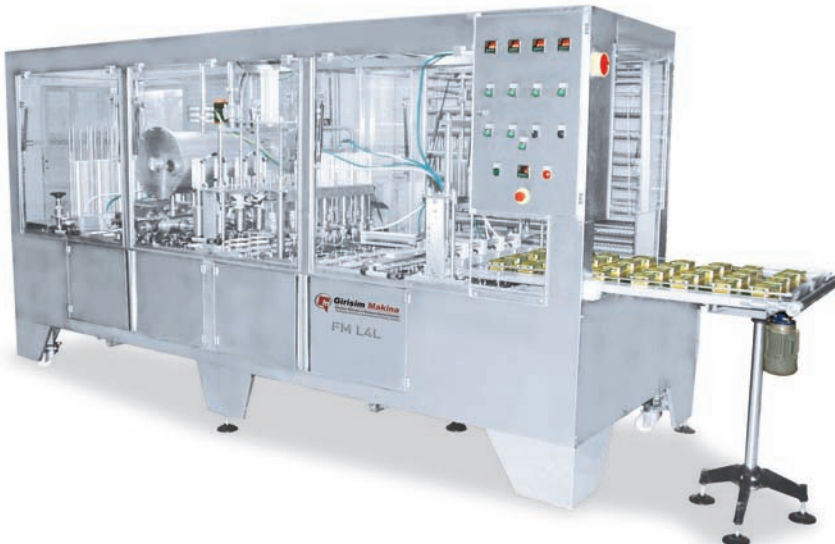

Machine remplissage pour fromage ecremer a system lineaire a 4 bras
Машина линейного типа для розлива сливочного сыра и укупорки
الخطية آلة 4-خط جبن كريمه التعبئة و ختم الآلة.

ÜRÜN GRAMAJI / PRODUCT WEIGHT: 100 gr. – 500 gr.



İstenilen farklı kase ölçülerinde rotary veya lineer olarak daha çok hatlı ve daha yüksek kapasiteli dolum makinası dizaynı yapılır.
Multi-line and higher-capacity filling machine designs can be done as rotary or linear for every bowl dimensions.

Krem peynir dışında şokella, bal, reçel, tereyağ, salça v.b kıvamda diğer ürünlerin dolum, kapama ve paketlemesini yapar. In addition to the cream cheese or labne cheese, the filling, sealing and packaging of chocolate, honey, jam, butter, tomato paste and other similar products can be done.

Machine d'emballage thermoformage
Термоформовочное оборудование
بالحرارة ماكينة التغليف

Termoform Paketleme Makinası
Thermoforming Packaging Machinery

TPM 3000

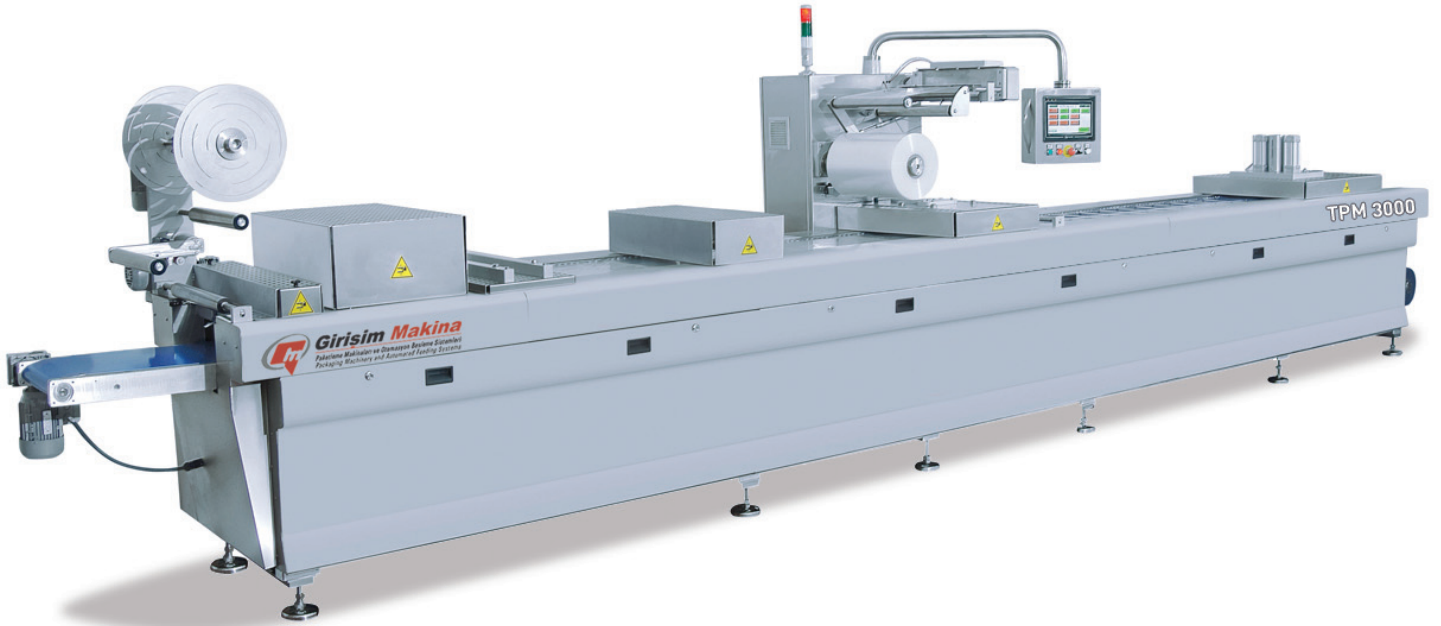

Teknik Özellikler / Technical Specifications

	TPM 1000	TPM 2000	TPM 3000
Kapasite / Capacity	6-8 vuruş/dak. 6-8 shots/min.	7-10 vuruş/dak. 7-10 shots/min.	7-10 vuruş/dak. 7-10 shots/min.
Hatve/Pitch	Max. 210 mm.	Max. 300 mm.	Max. 400 mm.
Width Options for Packaging Material	200-360 mm.	300 - 420 mm.	360 - 600 mm.
Ambalaj Malzemesi Packaging Material	Form verilebilir yumuşak ve sert ambalaj malzemesi Formable hard and soft packaging material		
Kontrol Paneli Control Panel	PLC Elektronik Kontrol Sistemi - Dokunmatik Ekran PLC Electronic Control System - Touch-screen Display		



- Makinanın temel üniteleri; ısıtma, form verme, yapıştırma ve kesme bölümlerinden ibarettir.
- Makinaya müşteri isteğine bağlı olarak tam otomatik dolun, vakumlama ve gaz verme üniteleri eklenebilir.
- Gıda sanayi başta olmak üzere geniş bir kullanım alanına sahiptir.
 - Gıda sanayinde et, köfte, hamburger, tavuk, işlenmiş et ürünleri (salam, sosis, sucuk, v.b.), balık, peynir çeşitleri, mantı, pizza, yufka, kadayıf, zeytin, turşu, çerez, kuru kayısı, incir, üzüm, helva, tatlılar ve benzeri geniş çeşitlilikte ürünler;
 - Tıp endüstrisinde steril olarak ambalajlanması gereken ürünler, enjektörler, kompres ve bandaj malzemeleri, operasyon ipliği, serumlar, tıbbi eldivenler, ameliyat malzemeleri ve benzer ürünler;
 - Bunun dışında; yedek parçalar, hırdavat, kırtasiye malzemeleri, oyuncaklar, bijuteri, nalburiye, temizlik bezleri ve benzeri çok çeşitli ürünlerin paketlenmesinde kullanılmaktadır.

- Heating, form shaping, filling, sealing and cutting stations constitute the basic units of the machine.
- Depending on the customer's request, automatic filling, vacuuming and gas injection units can be added to the machine.
- It has a wide usage area in different industries:
 - Products such as meat, meatball, chicken, processed meat products (salami, sausage, pepperoni etc.), fish, cheese, tortellini, pizza, olive, pickles, appetizers, dried fruits (apricot, fig, grape), deserts and other similar products in the food industry;
 - Products such as injectors, compress and bandage materials, filament for medical operations, serum, gloves, materials used in surgery and similar products which need to be packaged in sterile conditions in healthcare industry;
 - Spare parts, narrow goods, stationary items, toys, jewelry, hard goods, cleaning rags and similar products in the other industries.



Girişim Makina

Gıda İşleme ve Paketleme Makinaları
Food Processing and Packaging Machinery

GİRİŞİM MAKİNA İMALAT SANAYİ VE DIŞ TİCARET LTD. ŞTİ.

Yakuplu Merkez Mh. 63. Sk. No: 29 Ağaoğulları Plaza 34524 Beylikdüzü / İSTANBUL

Tel: +90 (212) 879 29 27 (Pbx) **Faks:** +90 (212) 879 29 27

www.girisimmak.com / info@girisimmak.com