

City Hotel Plovdiv
Plovdiv / Bulgaristan



Atek Fabrika Ek Binası
Hadımköy / İST.



Atek Showroom
Plovdiv / Bulgaristan



Beklediğin ürünler,
beklenmedik fiyatlarla...



ATEK
market.com



PROFESSIONAL SERIES

RIM REPAIR SYSTEMS

ATEK Professional RIM REPAIR SYSTEM Pangea 12" to 28"



12"-28"



lathe



gear box / redüktör



2045x1045x2100mm



Standard 24V DC



WEIGHT
Ağırlık
KG
940

kod. 36 00 CE

- Full automatic rim repair
- Digital measuring
- Rim diameter 12"-28"
- Vertical and horizontal measuring at the same time
- Two pcs Multiangular pressing heads
- Joystick control •Electronic rotate control
- New generation lathe (turning & moving)
- Gearbox
- Optional QuickClamp System
- Rim rotating speed 5-98 rpm
- Net weight 940 kg

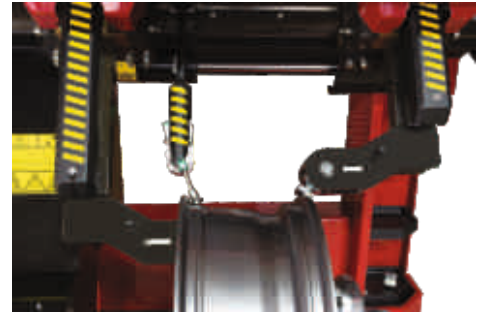

DIGITAL 10"-26"

kod. 56 00 CE

- Full automatic rim straightener
 - Digital measuring
- Multifunction support positions
 - Joystick control
 - Electronic rotate control
 - Moving lathe
 - Gearbox
- Rim rotating speed 5-98 rpm
- Net weight 720 kg
- Optional QuickClamp



10"-26"



lathe



gear box / redüktör



2045x1045x2100mm



Standard 24V DC

WEIGHT
Ağırlık
KG
720



Servis & Garaj Ekipmanları

ATEK MAKİNA PRODUCTION.

The World's First Industry 4.0 Ready Certified CNC Wheel Diamond Cutting Expert

Elegance

TP-01HV



Charisma

VTP-01HV



“Every wheel has right to be renewed.”

Long-Awaited User Experience With the Full HD 15.6" or 17.3" touchscreen, you will feel like using mobile phone. User friendly interface, specially designed in ATEK R&D.

Follow me, Step by step.

Start a new wheel, step by step. The “New” Mode of Elegance, specially designed for beginners and cautious operators. Easy, safe, fast. Get the best result in 6 steps. That's all.

Ergonomic, compact, foldable.

The control panel, which is specially designed for you to be in the best position during operation, provides a wide viewing experience with its superior ease of use and **17.3" or 15.6" Full HD touch screen.**

Advantage

Step-by-step user friendly interface
Handwheel simulation mode
Free-mode for deburr
Open mode for previous works
Save, e-mail, print

Up to 20.000 job storage
Ergonomic and movable control panel
Totally enclosed body design
Reinforced steel skid body
Rigid body design

Compact design to save space
Long-lasting electrostatic powder painting
Rim protection in case of power cut situations
Turning without removing the tire
Quick Spindle Stop to save time

Specifications

Laser measuring system (soon)
Probe measuring system
0.001 mm positioning sensitivity
Heavy duty linear guideway
Heavy duty ball screw

Electronic safe door lock
Led interior lighting
Embedded interior camera for reports
Black chrome chuck clamps
Skid protection brushes

Ergonomic chip pan
Led tower light with buzzer
4 point fast and manual lubricating
Air-cooling for machining



NEWLINE RIM REPAIR SYSTEMS

NEWLINE JANT DÜZELTME SİSTEMLERİ

JUMBO DOUBLE 10"-26"

kod. 84 00 / 84R 00

- Rim repair with double pistons
- New generation lathe (turning & moving)
- New generation bridge support kit
- V-belt (code 84 00) •Gear box (code 84R 00)
- Rim rotating speed 250 rpm (code 84 00)
- Rim rotating speed 98 rpm (code 84R 00)
- Net weight 455 kg



10"-26"



lathe



84R 00 g.box / r.tör



84 00 V-belt / kasnak



1554x1032x1853mm bridge s. / köprülü d.



NEW LINE 86/86R00 10"-24"

kod. 86 00 / 86R 00

- New generation lathe (turning & moving)
- Bridge support kit
- V-belt (code 86 00) •Gear box (code 86R 00)
- Rim rotating speed 250 rpm (code 86 00)
- Rim rotating speed 98 rpm (code 86R 00)
- Net weight 390 kg



10"-24"



lathe



86R 00 g.box / r.tör



86 00 V-belt / kasnak



bridge s. / köprülü d. 1198x972x1710mm



NEW LINE 8700 10"-24"

kod. 87 00

- New generation lathe (turning & moving)
- Standart big support kit
- Optional bridge support kit
- V-belt •Rim rotating speed 250 rpm
- Net weight 365 kg



10"-24"



lathe



V-belt / kasnak



1198x972x1710mm b.support / büyük d.



KONIG 55K00 10"-24"

kod. 55K 00

- Moving lathe •Bridge support kit
- Gear box
- Rim rotating speed 98 rpm
- Net weight 370 kg



10"-24"



lathe



gear box / redüktör



bridge s. / köprülü d. 1198x972x1710mm



Servis & Garaj Ekipmanları

ATEK MAKİNA PRODUCTION.

KONIG RIM REPAIR SYSTEMS

KONIG JANT DÜZELTME SİSTEMLERİ

KONIG 5400 10"-24"

kod. 54 00

- Moving lathe
- Big support kit
- Optional bridge support kit
- V-belt
- Rim rotating speed 250 rpm
- Net weight 365 kg



10"-24"



lathe



V-belt / kasnak



b.support / büyük d. 1410x972x1605mm

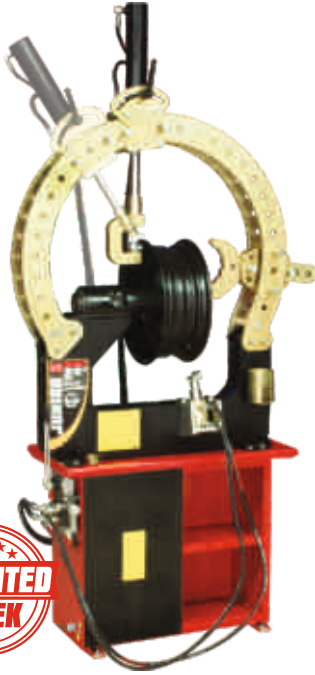
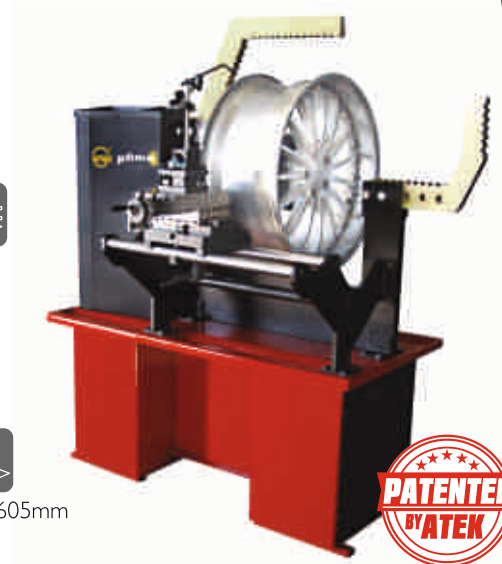

JUNIOR DOUBLE 10"-24"

kod. 14D 00

- Rim repair with double pistons
- New generation bridge support kit
- Net weight 200 kg
- Non-Lathe
- Non-motorized



10"-24"



bridge s. / köprülü d. 1233x430x1924mm

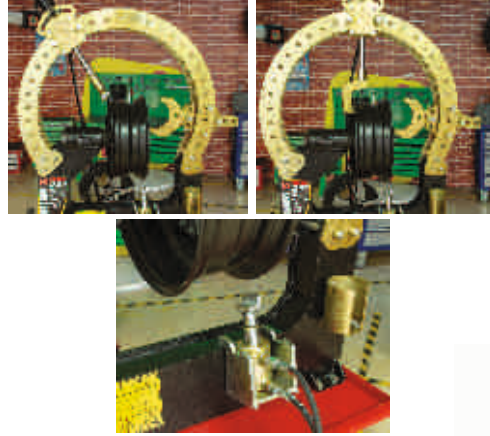

JUNIOR S 10"-24"

kod.14S 00

- Big support kit
- Net weight 165 kg
- Non-Lathe
- Non-motorized



10"-24"



b.support / büyük d.



1210x578x1404mm

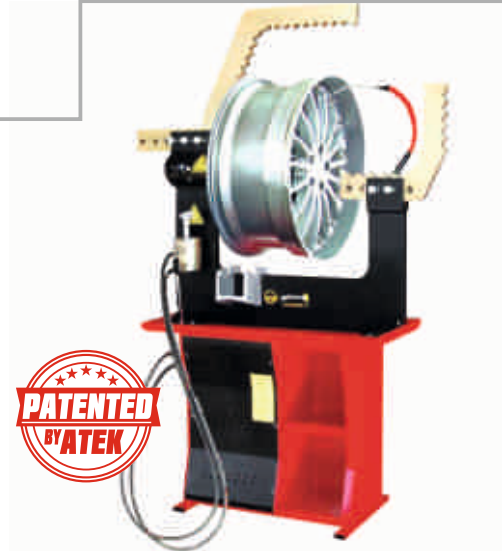

INFRARED RIM HEATER

kod.30 00

- Electrical Infrared Rim Heater
- Power : 380v 50-60 hz 6 kw
- Heating time: 2,5 min. \approx 100 $^{\circ}$
5 min. \approx 200 $^{\circ}$
- Time adjustable up to 4 minutes
- High temperature type silicon cable
- Adjustable heater height

RIM REPAIR, POLISHING & PAINTING SYSTEMS

JANT DÜZELTME VE JANT PARLATMA, BOYAMA SİSTEMLERİ

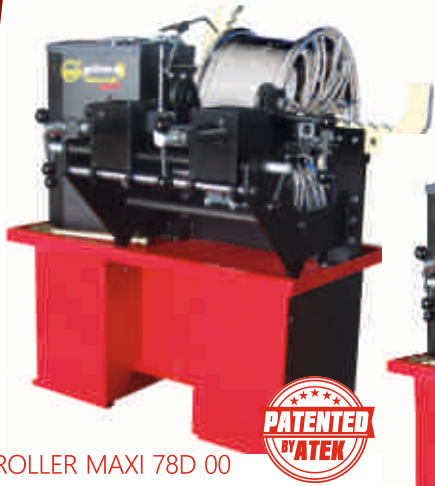

ROLLER MAXI 78D 00

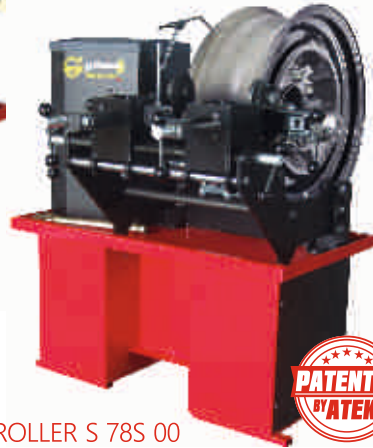

ROLLER S 78S 00



ROLLER MAXI/S 10"-19"

kod. 78D 00

- Rim repair
- Aluminium and steel rims
- Big support kit
- Gear box
- Rotating speed 98 rpm
- Net weight 368 kg

kod. 78S 00

- Rim repair
- Only steel rims
- Big support kit
- Gear box
- Rotating speed 98 rpm
- Net weight 300 kg



POLISH S / BRAVA POLISH

kod. 58 00

- Rim Diameter 11"-30"
- Gear box
- Rim rotating speed 12 rpm
- Net weight 240 kg

kod. 68BP 00

- Rim Diameter (Outside-In) 10" to 20"
- Rim Diameter (Inside-Out) 12"-22"
- Rim rotating speed 12 rpm



POLISH S 58 00



BRAVA POLISH 68BP 00



PAINTER SOLO

kod. 50S 00

- Single Rim Painting Cabinet
- Exproof Fan With Explosion Protection
- Exproof interior lighting
- 0.37 Kw 1.1 Amp. 2.950 D / D 380v 50-60hz
- Air Flow 2000 m3/h •Pressure Loss 300 Pa
- Yield 80% •Operating Temperature -40 / +50 C

PAINTER DUO

kod. 50 00

- Double Rim Painting Cabinet
- Exproof Fan With Explosion Protection
- Exproof interior lighting
- 0.37 Kw 1.1 Amp. 2.950 D / D 380v 50-60hz
- Air Flow 2000 m3/h •Pressure Loss 300 Pa
- Yield 80% •Operating Temperature -40 / +50 C



Servis & Garaj Ekipmanları

ATEK MAKİNA PRODUCTION.

PROFESSIONAL TYRE CHANGER SYSTEMS

PROFESYONEL LASTİK SÖKME TAKMA SİSTEMLERİ

MANAGER 12"-26" FULL AUTO

kod. 93 00

- Rim inside: 12"-24" •Rim outside: 14"-26" •Max. tyre dimensions: 38x115mm
- Engine power: 1,3/1,8 KW •Rotating speed: 8-16 Rpm •Weight: 380 kg
- Standard PLUS •Standard two speed •Standard ATEK SHELF

•Optional tyre shocking systems



12"-24"



14"-26"



38x115 cm



CALIPSO 10"-24" FULL AUTO

kod. 91 00

- Rim inside: 10"-22" •Rim outside: 12"-24" •Max. tyre dimensions: 32x108mm
- Engine power: 1,1 KW •Rotating speed: 8 Rpm •Weight: 250 kg
- OPS. PLUS •OPS. Engine power 1,3-1,8KW •OPS. two speed
- OPS. ATEK SHELF •OPS. tyre shocking systems



10"-22"



12"-24"



32x108 cm



PIERO 10"-22" FULL AUTO

kod. 92 00

- Rim inside: 10"-20" •Rim outside: 12"-22" •Max. tyre dimensions: 29x100mm
- Engine power: 0,75KW •Rotating speed: 8 Rpm •Weight: 235kg
- OPS. PLUS •OPS. Engine power 1,0-1,3KW •OPS. two speed
- OPS. ATEK SHELF •OPS. tyre shocking systems



10"-20"



12"-22"



29x100 cm



WINGS 10"-22" SEMI AUTO

kod. 90 00

- Rim inside: 10"-22" •Rim outside: 12"-22" •Max. tyre dimensions: 29x100mm
- Engine power: 0,75 KW •Rotating speed: 8 Rpm •Weight: 210 kg
- OPS. PLUS •OPS. Engine power 1,0-1,3KW •OPS. two speed



10"-22"



12"-24"



29x100 cm



AVANTGARDE TYRE CHANGER SYSTEMS

AVANTGARDE LASTİK SÖKME TAKMA SİSTEMLERİ



98 00 12"-26" FULL AUTO

kod. 98 00

- Rim inside: 12"-24" •Rim outside: 14"-26" •Max. tyre dimensions: 38x115mm
- Engine power: 1,3/1,8 KW •Rotating speed: 8-16 Rpm •Weight: 367 kg
- Standard PLUS •Standard two speed •Standard ATEK SHELF

•Optional tyre shocking systems



12"-24"



14"-26"



38x115 cm

97 00 10"-24" FULL AUTO

kod. 97 00

- Rim inside: 10"-22" •Rim outside: 12"-24" •Max. tyre dimensions: 32x108mm
- Engine power: 1,1 KW •Rotating speed: 8 Rpm •Weight: 236 kg
- OPS. PLUS •OPS. Engine power 1,3-1,8KW •OPS. two speed
- OPS. ATEK SHELF •OPS. tyre shocking systems



10"-22"



12"-24"



32x108 cm



96 00 10"-22" FULL AUTO

kod. 96 00

- Rim inside: 10"-20" •Rim outside: 12"-22" •Max. tyre dimensions: 29x100mm
- Engine power: 0,75KW •Rotating speed: 8 Rpm •Weight: 220 kg
- OPS. PLUS •OPS. Engine power 1,0-1,3KW •OPS. two speed
- OPS. ATEK SHELF •OPS. tyre shocking systems



10"-20"



12"-22"



29x100 cm

95 00 10"-22" SEMI AUTO

kod. 96 00

- Rim inside: 10"-22" •Rim outside: 12"-22" •Max. tyre dimensions: 29x100mm
- Engine power: 0,75 KW •Rotating speed: 8 Rpm •Weight: 207 kg
- OPS. PLUS •OPS. Engine power 1,0-1,3KW •OPS. two speed



10"-22"



12"-24"



29x100 cm



ATEK MAKİNA PRODUCTION.

NEW LINE TYRE CHANGER SYSTEMS

NEWLINE LASTİK SÖKME TAKMA SİSTEMLERİ

CARUZO 12"-26" FULL AUTO

kod. 80 00

- Rim inside: 12"-24" •Rim outside: 14"-26" •Max. tyre dimensions: 38x115mm
- Engine power: 1,3/1,8 KW •Rotating speed: 8-16 Rpm •Weight: 360 kg
- Standard PLUS •Standard two speed •Standard ATEK SHELF

•Optional tyre shocking systems



12"-24"



14"-26"



38x115 cm



ZANINI 10"-24" FULL AUTO

kod. 47 00

- Rim inside: 10"-22" •Rim outside: 12"-24" •Max. tyre dimensions: 32x108mm
- Engine power: 1,1 KW •Rotating speed: 8 Rpm •Weight: 220 kg
- OPS. PLUS •OPS. Engine power 1,3-1,8KW •OPS. two speed
- OPS. ATEK SHELF •OPS. tyre shocking systems



10"-22"



12"-24"



32x108 cm



RIVIERA 10"-22" FULL AUTO

kod. 43 00

- Rim inside: 10"-20" •Rim outside: 12"-22" •Max. tyre dimensions: 29x100mm
- Engine power: 0,75KW •Rotating speed: 8 Rpm •Weight: 210 kg
- OPS. PLUS •OPS. Engine power 1,0-1,3KW •OPS. two speed
- OPS. ATEK SHELF •OPS. tyre shocking systems



10"-20"



12"-22"



29x100 cm



BRAVA MAXI / BRAVA SEMI AUTO

kod. 04 00 MAXI / 04 00

- BRAVA MAXI Rim inside: 12"-24" •Rim outside: 14"-26" •Max. tyre dim.: 38x110mm
- Rim inside: 10"-22" •Rim outside: 12"-22" •Max. tyre dim.: 29x100mm
- Engine power: 0,75 KW •Rotating speed: 8 Rpm •Weight: 200 kg
- OPS. PLUS •OPS. Engine power 1,0-1,3KW •OPS. two speed



12"-24"



14"-26"



38x110 cm



10"-22"



12"-24"



29x100 cm

BRAVA MAXI 04 00 MAXI

BRAVA 04 00

www.atemakina.com

9

ATEK MAKİNA PRODUCTION.



Servis & Garaj Ekipmanları

FAVORITE TYRE CHANGER SYSTEMS

FAVORITE LASTİK SÖKME TAKMA SİSTEMLERİ



101 00 10"-24" FULL AUTO

kod. 101 00

- Rim inside: 10"-22" •Rim outside: 12"-24" •Max. tyre dimensions: 32x104mm
- Engine power: 1,3-1,8 KW •Rotating speed: 8-16 Rpm •Weight: 210 kg
- Standard two speed •Standard PLUS

•OPS. tyre shocking systems •OPS. ATEK SHELF



12"-24"



14"-26"



32x104 cm

100 00 10"-24" FULL AUTO

kod. 100 00

- Rim inside: 10"-20" •Rim outside: 12"-22" •Max. tyre dimensions: 29x100mm
- Engine power: 0,75KW •Rotating speed: 8 Rpm •Weight: 200 kg
- OPS. PLUS •OPS. Engine power 1,0-1,3KW •OPS. two speed
- OPS. ATEK SHELF •OPS. tyre shocking systems



10"-22"



12"-24"



29x100 cm



99 00 10"-22" SEMI AUTO

kod. 99 00

- Rim inside: 10"-22" •Rim outside: 12"-22" •Max. tyre dimensions: 29x95mm
- Engine power: 0,75 KW •Rotating speed: 8 Rpm •Weight: 192 kg
- OPS. PLUS •OPS. Engine power 1,0-1,3KW •OPS. two speed



10"-20"



12"-22"



29x95 cm



ZANINI BLACK EDT. 10"-24" FULL AUTO

kod. 47 00 BE

- Rim inside: 10"-20" •Rim outside: 12"-22" •Max. tyre dimensions: 32x108mm
- Engine power: 1,3-1,8KW •Rotating speed: 8-16 Rpm •Weight: 220 kg
- Standard PLUS •Standard two speed
- OPS. tyre shocking systems •OPS. ATEK SHELF



10"-22"



12"-24"



32x108 cm



Servis & Garaj Ekipmanları

ATEK MAKİNA PRODUCTION.

10

0090 444 21 31

HEAVY DUTY TYRE CHANGER SYSTEMS

KAMYON VE İŞ MAKİNASI LASTİK SÖKME TAKMA SİSTEMLERİ

SPEEDY 14"-56"

kod. 33 00

- Full automatic heavy duty tyre changer
- Standard two speed (6-12 rpm)
- Standard rim fixing clamp and
- Standard remote control
- Optional rim clamps 46"-56"
- Optional roller
- Optional tractor lever
- Net weight 860 kg



14"-56"



107-230 cm



1200 kg



- Standard remote control

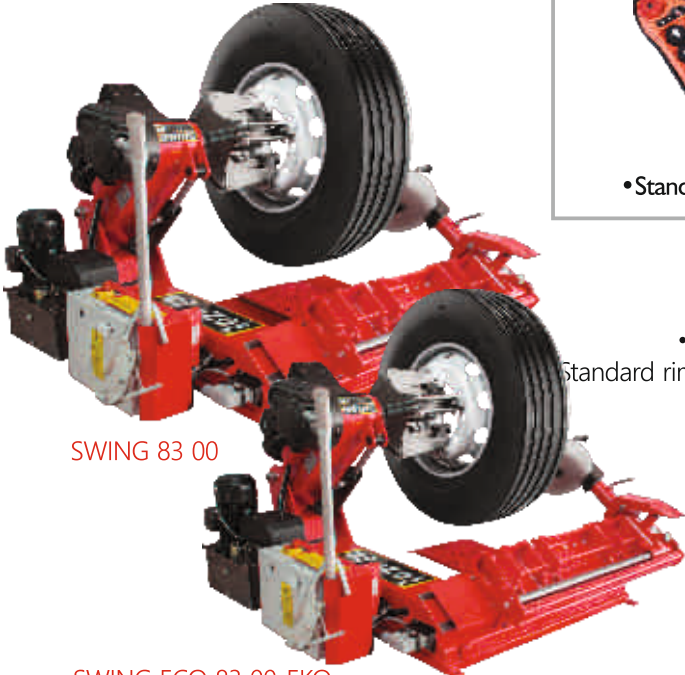

SWING 83 00

SWING ECO 83 00-EKO

- Standard remote control

SWING / SWING ECO 14"-30"

kod. 83 00 / 83 00-EKO

- Full automatic truck tyre changer
- Standard two speed (6-12 rpm)
- Standard rim fixing clamp and lever
- Standard remote control
- Optional roller
- SWING Net weight 542 kg
- SWING ECO Net weight 505 kg



14"-30"



70-160 cm



1000 kg



- Standard remote control

ALLEGRO / ALLEGRO ECO 14"-28"

kod. 53Y 00 / 66Y 00

- Full automatic truck tyre changer
- Standard two speed (6-12 rpm)
- Standard rim fixing clamp and lever
- Standard remote control
- Optional roller
- ALLEGRO Net weight 540 kg
- ALLEGRO ECO Net weight 510 kg



14"-28"



70-160 cm



1000 kg



ALLEGRO 53Y 00

ALLEGRO ECO 66Y 00

- Standard remote control

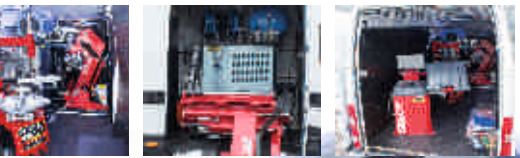

www.atekmakina.com

MOBIL ALLEGRO 14"-26"

kod.65 00

- Full automatic truck mobile tyre changer
- Optional two speed (6-12 rpm)
- Standard rim fixing clamp
- Standard lever
- Standard remote control
- Optional moving panel
- Standard roller
- Net weight 700 kg



14"-26"



60-130 cm



700 kg



- Standard remote control

ATEK MAKİNA PRODUCTION.



PASSANGER LIFTING SYSTEMS

ARAÇ KALDIRMA LİFT SİSTEMLERİ



PRIMA LIFT 3.2T

kod. 38 00

- Scissor lift 3,2 tons • Electrohydraulic
- Safety lock • Net weight 725 kg
- Platform dimensions: length: 141 cm (with ramp 210cm) width: 55cm
- Maximum height: 200cm
- Between two platforms: 85cm
- **OPTIONAL MECHANICAL LOCK**



3200 Kg



2000 mm



105 mm



RECEPTION LIFT 3.0T

kod.16R 00 / 16RK 00 / 16RK 00 KD

- Reception lift 3 tons • Electrohydraulic
- Safety lock • Mechanical Lock (16RK 00 / 16 RK 00 KD)
- Without Mechanical Lock (16R 00)
- Galvanized coated for outdoor (16 RK 00 KD)
- Net weight 450 kg
- Platform dimensions: length: 141 cm (with ramp 210cm) width: 55cm
- Maximum height: 100cm
- Between two platforms: 85cm



3000 Kg



1000 mm



105 mm



MOTO LIFT 3.0T

kod.42 00

- Motorcycle lift 750 kg
- Electrohydraulic
- Mechanic lock
- Minimum platform height 140mm
- Maximum lifting height 1000mm
- Minimum uzunluk 2100mm
- Maximum uzunluk 2631mm
- Platform width 903mm
- Working pressure 190 bar



750 Kg



1000 mm



140 mm



MULTI 1"

kod.05 00

- Electrical impact wrench
- Socket size 1"
- Max torque 950 Nm • Rotating speed 1400 rpm • Net weight 64 kg



Servis & Garaj Ekipmanları

ATEK MAKİNA PRODUCTION.

COMPRESSORS

KOMPRESÖRLER

FIAC MSU 98 I

kod.13 EE 6603B

- Mobil servisler için hizmet ünitesi
- 2 silindirli •17 hp
- Su soğutmalı dizel motor
- 12,5 kWA jeneratör •Akü
- 22 lt yakıt tankı
- Endüstriyel dizel yakıt filtresi
- 90 LT 12 bar kompresör tankı •Şartlandırıcı
- Trifaze ve monofaze elektrik priz çıkışları
- İki adet 16 ve 21m hava makarası



FIAC AB

- Çift pistonlu çift kademeli

	Volt hz/ph	tank lt	lt/min	cfm	bar	psi	hp	kW
AB 200/3	400/50/3	200	250	-	10	145	3	-
AB 300/550S	400/50/3	270	550	19,4	10/14	145/203	5,5	4
AB 500/850S	400/50/3	500	830	29,3	10/14	145/203	7,5	5,5

FIAC CRS

- Vidalı kompresörler



	Volt hz/ph	tank lt	lt/min	cfm	bar	psi	hp	kW
CRS 20	400/50/3	-	2010	70,9	13	116/189	20	15
CRS 20/500	400/50/3	500	2012	70,9	13	116/189	20	15



CAP DELTA 1000

- Mobil servisler için hizmet ünitesi
- Ekstra yalıtılmış duvarları sayesinde süper sessiz 78dB
- Su soğutmalı dizel motor
- 17 hp •15 kWA LOMBARDINI KOHLER jeneratör
- Çift kademe çift silindirli •Akü
- Elektrik marşlı
- 22 lt yakıt tankı
- Endüstriyel dizel yakıt filtresi
- 80 LT 12 bar kompresör tankı •Şartlandırıcı
- Trifaze ve monofaze elektrik priz çıkışları
- İki adet 16 ve 21m hava makarası

MARUNI TYRE REPAIR SERIES

MARUNI LASTİK TAMİR YAMALARI

MARUNI ROUND / YUVARLAK

- Round inner tube patches
- Yuvarlak iç lastik tamir yamaları



Maruni
LASTİK TAMİR MALZEMELERİ



	Size(mm)	Pcs layer
	Ebat	Tabaka adeti
MODEL R	25	1 tab. 64 ad
MODEL S2	30	1 tab. 36 ad
MODEL M2	40	1 tab. 25 ad
MODEL L3	52	1 tab. 16 ad
MODEL Q03	61	1 tab. 9 ad
MODEL R03	76	1 tab. 9 ad
MODEL R04	108	1 tab. 4 ad

MARUNI OVAL / OVAL

- Oval inner tube patches
- Oval iç lastik tamir yamaları

Maruni
LASTİK TAMİR MALZEMELERİ



	Size(mm)	Pcs layer
	Ebat	Tabaka adeti
MODEL S	24x34	1 tab. 48 ad
MODEL M	28x42	1 tab. 35 ad
MODEL M3	24x57	1 tab. 32 ad
MODEL L	33x53	1 tab. 24 ad
MODEL L2	41x76	1 tab. 15 ad
MODEL OV01	41x107	-
MODEL OV02	66x138	1 tab. 6 ad
MODEL OV03	91x159	1 tab. 6 ad



Maruni
LASTİK TAMİR MALZEMELERİ



MARUNI SUPER VALKARN G

- kod.21 03 38186** Super Valkarn G 100cc (140gr)
- kod.21 03 38188** Super Valkarn G 200cc (280gr)
- kod.21 03 38190** Super Valkarn G 1000cc (1400gr)
- Outer tube solutions
- Diş lastik yama solüsyonları

Maruni
LASTİK TAMİR MALZEMELERİ



MARUNI VALKARN

- kod.21 03 35186** Valkarn 100cc (140gr)
- kod.21 03 35188** Valkarn 200cc (280gr)
- kod.21 03 35190** Valkarn 1000cc (1400gr)
- Inner tube solutions
- İç lastik yama solüsyonları



MARUNI THERMO LIQUID

Thermo liquid 1000cc (1300gr)

- Inner tube thermo solution
- İç lastik sıcak yama solüsyonu



MARUNI BEAD SEALER

•Sealing between the rim

- Lastik jant arası sızdırmazlık solüsyonu
- Bead Sealer 1000cc (1300gr)



MARUNI SEALINER

Sealiner 1000cc (1300gr)

- Tyre patch for long life
- Lastik yaması koruyucu solüsyonu



DISTRIBUTOR IS ATEK MAKINA

MARUNI TYRE REPAIR SERIES

MARUNI LASTİK TAMİR YAMALARI

MARUNI MR(GNR)

- Radial tire patches
- Diş lastik radyal yamaları



Size(mm) Ebat	Pcs box Kutudaki adet										
MR-08	48x68	20	•								
MR-10	56x77	20	•								
MR-12	70x120	10	•	•							
MR-14	82x130	10	•								
MR-18	75x100	10		•	•						
MR-20	85x135	10		•	•	•	•	•	•	•	•
MR-22	80x180	10			•				•	•	
MR-25	119x133	10				•	•				
MR-35	130x180	10				•	•				
MR-40	115x200	10			•	•	•	•			
MR-42	130x270	10				•	•	•			
MR-44	130x335	10				•	•				•
MR-45	180x230	10				•	•				•
MU (GUT)(ÇİVİ DELİKLERİ İÇİN)											
MU-A0	34	100	•								
MU-00	43	100	•								
MU-01	65	50	•								
MU-02	78	50	•								
MU-BO	52	50									



MARUNI MB/MS(GBT/GBS)

- Diagonal tire patches
- Bezli lastik yamaları



Size(mm) Ebat	Pcs box Kutudaki adet										
MB-01	60	30	•								
MB-02	80	15	•								
MB-03	98	10	•	•	•	•	•	•			
MB-04	127	10	•	•	•	•	•	•			
MB-05	165	10	•	•	•	•	•	•			
MB-06	240	10	•	•	•	•	•	•			
MB-07	295	10	•	•	•	•	•	•			
MB-08	345	10	•	•	•	•	•	•			
MB-09	390	10	•	•	•	•	•	•			
MB-10	450	5	•	•	•	•	•	•			
MB-20	255	10							•	•	•
MB-21	370	5							•	•	•
MB-23	255	10							•	•	•
MB-25	510	3							•	•	•
MS-06	240	10		•	•	•	•	•	•	•	•
MS-07	295	10		•	•	•	•	•	•	•	•
MS-08	345	10		•	•	•	•	•	•	•	•



MARUNI PW

- Plug patches
- Mantar yamaları

Size(mm) Ebat	Pcs box Kutudaki adet	
		PW 3505
PW 4007	80	16
PW 5609	98	20
PW 8012	127	6

MARUNI POWER VALKASEAL

- Valkaseal
- Fital yamalar



Size(mm) Ebat	Pcs box Kutudaki adet	
		L 1430
L 2030	200	30



UNITROL BALANCING

UNITROL BALANSLARI



UNI-TROL



UNITROL MONOLITH

kod.10 02 MONOLITH

- 20" LCD ekran, •Jant ölçüsü: 10"-30"
- Jant genişliği: maks. 15", •Lastik ölçüsü: 36"
- Lastik dönüş hızı: 175 rpm, •Maks. lastik ağırlığı: 80 kg.
- Kolay, hızlı Türkçe menü ve seslendirme
- SPLIT (kurşun bölme özelliği), •Otomatik Mesafe Ölçümü
- Hava Girişi: 6-10 bar, •Lazer ile kurşun yerini gösterme
- Havalı lastik kilitleme



UNITROL TOTEM

kod.10 02 MONOLITH

TOTEM tekerlek parametrelerini giren lazer ölçüm koluna ve tekerleği dengesizlik noktasına yönlendiren tekerlek yönlendirme sistemine sahip bir lastik balansıdır.

Makine, temassız tekerlek genişliği ölçümü için ultrasonik sonar ve girilen parametrelere göre jant tanıma sistemi ile donatılmıştır. LAZERLİ, SONAR SİSTEMLİ

UNI-TROL



UNI-TROL



UNITROL 2162

kod.10 02 2162

- 20" LCD ekran •Jant ölçüsü: 10"-26"
- Jant genişliği: maks. 20"
- Lastik dönüş hızı: 120 rpm
- Maks. lastik ağırlığı: 200 kg.
- Kolay, hızlı Türkçe menü ve seslendirme,
- Bütün kurşun tiplerini tanıyabilme
- Binek ve Kamyon Lastiklerine Uyumlu
- Standart lastik asansörü



UNITROL MICRO M

kod.10 02 MICRO M

- Dijital ekranlı •Jant ölçüsü: -
- Jant genişliği: maks. 3"-12"
- Lastik ölçüsü: 740mm •Lastik dönüş hızı: - rpm
- Maks. lastik ağırlığı: 60 kg.
- Kolay, hızlı menü ve grafikler, •Bütün kurşun tiplerini tanıyabilme özelliği

UNI-TROL



DISTRIBÜTÖR İS ATEK MAKİNA

FASEP BALANCING

FASEP BALANSLARI

FASEP V643 G3

kod.10 04 V 643

- 20" LCD ekran, •Windows Mobile
- SONAR SİSTEMLİ
- LAZER İLE KURŞUN YERİNİ GÖSTERME
- PNÖMATİK HAVALI LASTİK KİLİTLEME
- Jant ölçüsü: 10"-26" •Jant genişliği: maks. 16"
- Lastik ölçüsü: 34" •Lastik dönüş hızı: 42-98 rpm
- Maks. lastik ağırlığı: 90 kg.
- Kolay, hızlı Türkçe menü ve grafikler
- Bütün kurşun tiplerini tanıyabilme özelliği

FASEP



FASEP



FASEP V585

kod.10 04 V 585

- 20" LCD ekran, •Windows CE
- SONAR SİSTEMLİ
- LAZER İLE KURŞUN YERİNİ GÖSTERME
- PNÖMATİK HAVALI LASTİK KİLİTLEME
- Jant ölçüsü: 10"-26" •Jant genişliği: maks. 16"
- Lastik ölçüsü: 34" •Lastik dönüş hızı: 42-98 rpm
- Maks. lastik ağırlığı: 90 kg. •Kolay, hızlı Türkçe menü ve grafikler
- Bütün kurşun tiplerini tanıyabilme özelliği

FASEP V558

kod.10 04 E555

- 20" LCD ekran, •Windows CE
- SONAR SİSTEMLİ
- LAZER İLE KURŞUN YERİNİ GÖSTERME
- Jant ölçüsü: 10"-26" •Jant genişliği: maks. 16" •Lastik ölçüsü: 34"
- Lastik dönüş hızı: 42-98 rpm •Maks. lastik ağırlığı: 90 kg.
- Kolay, hızlı Türkçe menü ve grafikler
- Bütün kurşun tiplerini tanıyabilme özelliği

FASEP



FASEP



FASEP B150T

kod.10 04 B150T

- Mobil ağır vasıta araç lastik servisleri için balans makinası
- Motorsuz Dijital ekranlı
- Jant ölçüsü: 8"-26" •Jant genişliği: maks. 16" •Lastik ölçüsü: 49"

FASEP V590

kod.10 04 V590

- Kamyon ve otobüs lastikleri için
- LCD ekran •Jant ölçüsü: 8"-26"
- Jant genişliği: maks. 8,5"-28"
- Lastik ölçüsü: 50" •Maks. lastik ağırlığı: 200 kg.
- Lastik asansörlü



JACKS & MOUNTING PASTE

KRIKO & LASTİK MONTAJ KREMLERİ



TORTARELLI 15-25-50T

kod. 05 GM 00001

- Hidroprömatik kriko
- Yük kaldırma kapasitesi 15-25-50 ton
- Maks kaldırma yüksekliği 327mm (497mm soketli)
- Min yükseklik 156mm
- Çalışma basıncı 8 bar
- Net ağırlık 60 kg



TİMSAH KRIKOLAR

Size
Ebat

2 ton	1180x140x800mm
2 ton low profile	1310x120x590mm
3 ton	1420x140x560mm
5 ton	1550x150x560mm
10 ton	1430x180x670mm



GARAJ KRIKOSU 3T

kod. 05 03 00001

- Alçak profilli arabalı kriko
- Kaldırma kapasitesi: 3 ton
- Kaldırma yüksekliği: 440 mm
- Min. yükseklik: 76 mm
- Ağırlık: 44 kg
- Ebatlar: 600x90x460 mm

MOUNTING PASTE MONTAJ KREMI

MADE IN ATEK MAKİNA



DISTRIBUTÖR İS ATEK MAKİNA

TYRE INFLATORS

HAVA SAATLERİ



PCL D13

kod.30 08 D-13

- Binek araçlar ve ağır vasıta
- Dijital ekranlı •4 çıkışlı



PCL D12

kod.30 08 D-12

- Binek araçlar ve ağır vasıta
- Dijital ekranlı



PCL D10

kod.30 08 D-10

- Binek araçlar ve hafif ticari araçlar
- Dijital ekranlı



PCL A10

kod.30 08 A-10

- Binek araçlar ve hafif ticari araçlar
- Analog ekranlı



PCL AIRFORCE

kod.30 08 0002AF

- Analog ekranlı



PCL ACCURA

kod.03 08 DAC1A08

- Dijital ekranlı



PCL DT108

kod.03 08 DT108

- Dijital ekranlı



PCL MK-3

kod.30 08 00002

- Analog ekranlı
- Metal gövde



PCL MK-4

kod.03 08 DAC403

- Dijital ekranlı
- Metal gövde



Schrader Mast-Air

kod.30 39106-00

- Analog ekranlı



JAMEC TDR5000

kod.30 08 TDR5000

- Analog ekranlı



JAMEC TDR4000

kod.30 08 TDR4000

- Dijital ekranlı



JAMEC TDR3000

kod.30 08 TDR3000

- Dijital ekranlı



JAMEC TDR2000

kod.30 08 TDR2000

- Analog ekranlı
- Metal gövde



IMPACT WRENCH & SOCKETS

BİJON TABANCALARI & LOKMALAR



KUKEN 430P 1"

kod.38 KK 430P

- 1"
- 2200 Nm tork
- 4300 rpm



KUKEN 19HP 1/2"

kod.38 KK 430P

- 1/2"
- 450 Nm tork
- 6000 rpm



ROTAKE RT8805 3/4"

kod.38 RT 8805

- YENİ TEKNOLOJİ FIRÇASIZ MOTOR
- 3/4" Soket Ölçüsü •1700Nm Tork
- 20V 6Ah Batarya Kapasitesi
- 2 ad. Li-ion Batarya •3 Kademeli Tork Ayarı



ROTAKE RT8804 1/2"

kod.38 RT 8804

- YENİ TEKNOLOJİ FIRÇASIZ MOTOR
- 1/2" Soket Ölçüsü •1700Nm Tork
- 20V 6Ah Batarya Kapasitesi
- 2 ad. Li-ion Batarya •3 Kademeli Tork Ayarı



ROTAKE RT8803 1/2"

kod.38 RT 8803

- YENİ TEKNOLOJİ FIRÇASIZ MOTOR
- 1/2" Soket Ölçüsü •1080Nm Tork
- 20V 6Ah Batarya Kapasitesi
- 2 ad. Li-ion Batarya •3 Kademeli Tork Ayarı



ATEK Hava Reali 1/2"

kod.16 OR 2015

- 12m hortum
- Geri sarma,
- Metal gövde



ATEK Hava Reali 1"

kod.16 OR 2015

- 18m hortum
- Geri sarma,
- Metal gövde

SOCKET BOX SETS LOKMA SETİ KUTULU

kod.SC 015 06 1" uzun, 8 Parça 24-41 mm

kod.SC 003 04 1/2" kısa, 10 Parça 10-24 mm

kod.SC 003 05 1/2" uzun, 10 Parça 10-24 mm



DISTRİBÜTÖR İS ATEK MAKİNA

VALVES & WHEEL WEIGHTS

SİBOPLAR & BALANS KURŞUNLARI



TR 414

TR 414 ALLIGATOR kod.29 02 0414ALG
TR 414 EHA S kod.29 02 0414ES
TR 414 EHA kod.29 02 0414E
TR 414 kod.29 02 0414C



TR 414 METAL

TR 414 Metal kod.29 04 00414D
TR 414 Eğimli metal kod.29 04 004148



BMW İNCE SOMUN

kod.29 20 01416 Bmw uzun ince tip sibop



AĞIR VASITA SİB.

kod.26 01 01019 Uzun Somunlu Jant Sibobu
kod.29 01 01004 Tub. Kam. Metal 4 cm
kod.29 01 01005 Tub. Kam. Metal 5 cm
kod.29 01 01007 Tub. Kam. Metal 7 cm
kod.29 01 01009 Tub. Kam. Metal 9 cm
kod.29 01 01011 Tub. Kam. Metal 11,5 cm
kod.29 01 01013 Tub. Kam. Metal 13 cm
kod.29 01 01015 Tub. Kam. Metal 15 cm
kod.29 01 01018 Tub. Kam. Metal 18 cm



AĞIR VASITA SİB.

kod.29 12 00003C Pilot tubeless sibop
kod.29 12 00005 İş mak. TR-5720 dorse



İŞ MAKİNASI SİB.

kod.29 01 01618 İş mak. kauçuk dipli
kod.29 01 00618 Traktör tubeless metal



HOFMANN NORMAL

5 gr	kutuda 100 adet
10 gr	kutuda 100 adet
15 gr	kutuda 100 adet
20 gr	kutuda 100 adet
25 gr	kutuda 100 adet
30 gr	kutuda 100 adet
35 gr	kutuda 100 adet
40 gr	kutuda 100 adet
45 gr	kutuda 50 adet
50 gr	kutuda 50 adet
55 gr	kutuda 50 adet
60 gr	kutuda 50 adet



HOFMANN TURBO

5 gr	kutuda 100 adet
10 gr	kutuda 100 adet
15 gr	kutuda 100 adet
20 gr	kutuda 100 adet
25 gr	kutuda 100 adet
30 gr	kutuda 100 adet
35 gr	kutuda 100 adet
40 gr	kutuda 100 adet
45 gr	kutuda 50 adet
50 gr	kutuda 50 adet
55 gr	kutuda 50 adet
60 gr	kutuda 50 adet



HOFMANN YAPIŞTIRMA

60 gr Slim	kutuda 100 adet
60 gr Slim Metal	kutuda 50 adet



TAKIM DOLABI

kod. 03 50 BİJ-001

- 5 Çekmeceli boş
- Mobil
- Elektrostatik toz boyalı uzun ömürlü



ÇALIŞMA MASASI

kod. 03 50 BİJ-002

- 6 Çekmeceli boş
- Elektrostatik toz boyalı uzun ömürlü



LASTİK YANAK AÇICI

kod.KTJ-658

- 8-10 bar çalışma basıncı
- Işıklı aydınlatma
- Kolay ve hızlı kullanım

KENT YAĞLAMA SİSTEMLERİ

- 16 OC 41175 Yağ çekme ve toplama cihazı fanuslu hunili
- 16 OC 40175 Yağ çekme cihazı 75 lt fanussuz
- 16 OC 42275 Yağ çekme ve toplama cihazı fanussuz hunili
- 16 OD 40275 Yağ çekme ve toplama cihazı fanussuz hunili
- 16 OD 44075 Yağ çekme cihazı tavalı 14lt 75lt tank
- 16 OD 44120 Yağ çekme cihazı tavalı 50lt 120lt tank
- 16 OD 43030 Manuel yağ dolum cihazı 30lt
- 16 OD 43130 Havalı yağ dolum cihazı 30lt
- 16 OD 43275 Pompalı yağ dolum cihazı dijital tanabcalı
- 16 OD 40075 Yağ çekme cihazı 75lt hunisiz
- 16 OG 36200 Yağ dolum tabancası dijital sayaçlı
- 16 GM 55015 Havalı gres 15 kg
- 16 GM 55130 Havalı gres 30 kg
- 16 OR 28000 Açık yağ makarası
- 16 AT 28020 Hava reali 20m hortumlu
- 16 OP 31094 Yağ pompası 3/1
- 16 OP 51094 Yağ pompası 5/1
- 16 GP 50194 Gres pompası





CORGHI UNIFORMITY 32"

- Arıza tespitli lastik sökme takma makinası
- Leveysiz lastik sökme takma
- 32" Jant çapı •47" Lastik çapı
- Röleli •Dijital ekranlı
- Lazer ile jant ve lastik hatalarını tarama
- Elektrikli göbekten jant bağlamalı
- Lastik kaldırma asansörlü
- Çift yanak düşürme kolu •Çift devirli
- Dijital lastik diş derinlik ölçüleri
- Her türlü otomobil ve 4x4 arazi taşıtlarına uygun
- Opsiyonel lastik kaldırma asansörü
- Hava basıncı 8-10 bar •380 kg makina ağırlığı



Bu ürün, bu markalar tarafından akredite edilmiştir.

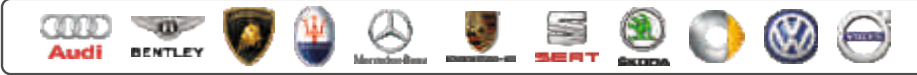

CORGHI MASTER FORCE 32"

- 32" Jant çapı •47" Lastik çapı •Kameralı •Lazer ile tarama
- HİDROLİK MOTOR VE HİDROLİK LASTİK KİLİTLEME**
- Dokunmatik ekranlı •Otomatik sıvı montaj kremi püskürtme
- Elektrikli göbekten jant bağlamalı •Lastik kaldırma asansörlü
 - Otomatik lastik damak düşürme
 - Otomatik hava basınç dolumu
- Araç modeline göre sibop sensör algılama
 - Lastik yüzeyinin sıcaklığını ölçme
 - Dijital lastik diş derinlik ölçüleri
- Tam otomatik insansız sökme takma
- Her türlü otomobil ve 4x4 arazi taşıtlarına uygun
 - Lastiği sadece makinaya monre edin,
 - Dokunmatik ekrandan başlatın ve
 - Sadece artiglio master code yi seyredin.
- Hava basıncı 8-10 bar •Maksimum 85 kg lastik ağırlığı
- 95 kg makina ağırlığı •Ebatlar: 1760x2187x1840mm

CORGHI MASTER CODE 32"

- 32" Jant çapı •47" Lastik çapı •Kameralı •Lazer ile tarama
- Dokunmatik ekranlı •Otomatik sıvı montaj kremi püskürtme
- Elektrikli göbekten jant bağlamalı •Lastik kaldırma asansörlü
- Otomatik lastik damak düşürme
- Otomatik hava basınç dolumu
- Araç modeline göre sibop sensör algılama
- Lastik yüzeyinin sıcaklığını ölçme
- Dijital lastik diş derinlik ölçüleri
- Tam otomatik insansız sökme takma
- Her türlü otomobil ve 4x4 arazi taşıtlarına uygun
- Lastiği sadece makinaya monre edin,
- Dokunmatik ekrandan başlatın ve
- Sadece artiglio master code yi seyredin.
- Hava basıncı 8-10 bar •Maksimum 85 kg lastik ağırlığı
- 95 kg makina ağırlığı •Ebatlar: 1760x2187x1840mm



Bu ürün, bu markalar tarafından akredite edilmiştir.

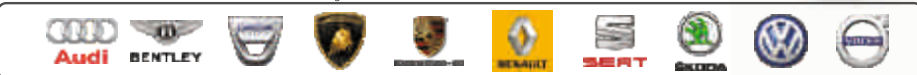



CORGHI ART. MASTER MI 26"

- 12 "-26" lastik sökme ebadı
- Lastik kaldırma asansörü
- Çift devirli hava saatli
- Yeni hızlı perfonmansı arttırılmış üniversal lastik bağlama sistemi
- Otomatik PAX sistem lastik seçimi
- Dijital hava Saati
- Her türlü otomobil ve 4x4 Arazi taşıtlarına uygun
- 65 kg maksimum lastik ağırlığı
- Hava basınç 8-10 bar
- 465 kg makina ağırlığı
- Ebatlar: 1300x2100x1600 mm

CORGHI ART. MASTER JOLLY 26"

- 12 "-26" lastik sökme ebadı
- Lastik kaldırma asansörü
- Çift devirli hava saatli
- Otomatik göbekten sıkmalı
- Yeni hızlı perfonmansı arttırılmış üniversal lastik bağlama sistemi
- Otomatik pax sistem lastik seçimi
- Dijital hava saati
- Her türlü otomobil ve 4x4 arazi taşıtlarına uygun
- 65 kg maksimum lastik ağırlığı
- Hava basınç 8-10 bar
- 465 kg makina ağırlığı
- Ebatlar: 1134x1844x1904 mm

Bu ürün, bu markalar tarafından akredite edilmiştir.

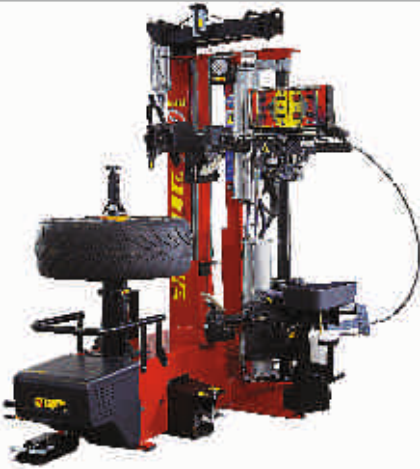

CORGHI ARTIGLIO 5000 26"

- 12 "-26" lastik sökme ebadı
- Lastik kaldırma asansörü
- Çift devirli hava saatli
- Yeni hızlı perfonmansı arttırılmış üniversal lastik bağlama sistemi
- Otomatik pax sistem lastik seçimi
- Dijital hava saati
- Her türlü otomobil ve 4x4 arazi taşıtlarına uygun
- 65 kg maksimum lastik ağırlığı
- Hava basınç 8-10 bar
- 465 kg makina ağırlığı
- Ebatlar: 1134x1844x1904 mm

CORGHI ARTIGLIO 500 32"

- "Leveysiz" full otomatik
- Göbekten sıkmalı leveysiz sistem
- 32" janta kadar lastik söküp takabilme
- Çift yanak düşürme kolu
- Çift devirli
- 85 kg maksimum lastik ağırlığı
- 380 kg makina ağırlığı
- Hava saati
- 230v monofaze hava basıncı 8 bar
- Standart lastik kaldırma asansörü
- Ebatlar:1290x1700x2000mm



CORGHI ARTIGLIO 50 30"

- "Leveysiz" full otomatik
- Göbekten sıkmalı leveysiz sistem
- 30" janta kadar lastik söküp takabilme
- Tek yanak düşürme kolu
- Çift devirli
- 85 kg maksimum lastik ağırlığı
- 380 kg makina ağırlığı
- Hava saati
- 230v monofaze hava basıncı 8 bar
- Standart lastik kaldırma asansörü
- Ebatlar:1290x1700x2000mm

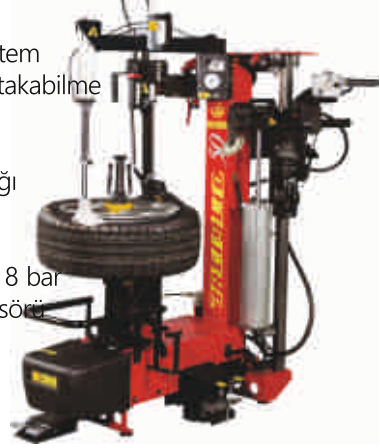

DISTRIBUTOR IS ATEK MAKINA



CORGHI SPACE SAVER 24"

- Otomatik lastik sökme takma makinası
- 24" Jant çapı
- Çift devirli
- Standart Şoklama Sistemli
- Standart RunFlat lastikler için PLUS aparatı
- Hava basıncı 8-10 bar

Artiglio Space Saver yeni geliştirilen hareketli direk sayesinde yan dönüş ve yukarı yükseliş prensibi ile çalışır. Bu yenilik direğin pnömatik dönüşü ile, azaltılmış çalışma boyutları sağlar ile makinanın duvara daha yakın olmasını ve daha az yer kaplamasını sağlar.



CORGHI A2030 26"

- 26" Lastik Ebadı
 - Full Otomatik
 - Kare Döner Tablalı
 - Kafa Arkaya Yatma Özelliği
 - Opsiyonel Çift Devirli
 - Opsiyonel Şoklama Sistemli
 - Opsiyonel Performans Lastikleri İçin Yardımcı Kol
 - Yüksekliği Ayarlanabilir Damak Düşürme Kolu
 - 259kg Makine Ağırlığı
 - Ebatlar:1240x1840x1770mm
- stik genişliğine göre ayarlanabilir damak düşürme mekanizması

CORGHI A222 10"-25"

- 10-25" Jant çapı
- 39" Lastik Ebadı
- Full Otomatik
- Kare Döner Tablalı
- Kafa Arkaya Gitme Özelliği
- Standart Çift Devirli
- Opsiyonel RunFlat lastikler için PLUS aparatı
- 225kg Makine Ağırlığı
- Ebatlar:1240x1840x1770mm





CORGHI EYELIGHT PLUS 32''

- 23" dokunmatik ekranlı lcd ekran
- Otomatik davlumbaz açma
- 3d lastik ve jant tarama
- Otomatik jant ve lastik ebat ölçümü
- Maksimum jant çapı:32" •Maksimum lastik genişliği:600mm 23,6"
- Maksimum lastik çapı:1117mm / 44" •Maksimum lastik ağırlığı:75kg
- Otomatik olarak janta uygun kurşun programını belirler
- Lazer ile lastik ve jant yüzeyindeki hataları tarama
- Tek ölçüm ile jant ve lastiği ayrı olarak deformasyonunu Raporlama (eğrilik, yalpa, salgı, merkezden kaçıklık)
- Yüksek performans araçları için ultra hassas ölçüm modu



CORGHI EM 9580 C PLUS 28''

- 6sn de balans ölçümü
- Sonar sistemli otomatik jant ölçümü,
- Joystik ile kolay ve hızlı menü kullanımı
- Lazer ile kurşun yerini gösterme
- Elektromekanik lastik kilitlemeli •20" lcd ekran
- Otomatik davlumbaz açma
- Otomatik jant ve lastik ebat ölçümü
- Balans hassasiyeti: 1gr balans süresi:6 s
- Maksimum jant çapı: 28"
- Maksimum lastik genişliği: 600mm 23,6"
- Maksimum lastik çapı: 1117mm/44"
- Maksimum lastik ağırlığı: 75kg



CORGHI EM 9380 C 32''

- Dıştan otomatik ölçüm
- Havalı lastik kilitleme (9980 c)
- 20" lcd ekran •Otomatik jant ve lastik ebat ölçümü
- Balans hassasiyeti: 1 gr •Balans süresi: 7 sn
- Maksimum jant çapı: 28"
- Maksimum lastik genişliği: 600mm/ 23,6"
- Maksimum lastik çapı: 1117mm/44"
- Maksimum lastik ağırlığı: 75kg



CORGHI EM 9280 C 28''

- 20 lcd ekran •Dıştan sonarlı lastik ebad ölçümü
- Lazerli •Balans hassasiyeti: 1 g
- Maksimum jant çapı: 28"
- Maksimum lastik genişliği: 600mm/23,6"
- Maksimum lastik çapı: 1117mm/44"
- Maksimum lastik ağırlığı: 75kg



CORGHI REMO COMPACT DUO / 4C

DÜNYADA İLK ROBOT TEKNOLOJİSİ İLE HER TÜRLÜ JANT VE LASTİĞE TEMAS ETMEDEN HASSAS BİR ŞEKİLDE ANALİZ EDER

R.E.M.O. TEKNOLOJİSİ

- Lastik ve janta herhangi bir bağlantı olmadan çalışan bu teknoloji ile jantları çizme ihtimaliniz olmaz.
- Binek ve hafif ticari araçlarda ön hazırlık olmadan hızlıca analize başlayın.

AVANTAJLARINIZ

- Tüm lift modellerinde kullanılabilir.
- Kullanıcı dostu olduğu için özel eğitilmiş personel ihtiyacınız olmaz.
- Temel araç bilgileri girildikten sonra R.E.M.O. başında beklemenize gerek duymazsınız.
- Bu zaman tasarrufu ile yoğun işletmelerde veya yoğun lastik değişim sezonlarında avantaj sağlar.



REMO COMPACT DUO



REMO COMPACT 4C



CORGHI REMO RAPIDE

- Birkaç saniyede RAPIDE, operatöre ihtiyaç duymadan ve janta dokunmadan aracın hizalama durumunu kontrol eder.
- Ek olarak, entegre yönetim sistemi sayesinde, alım adımı sırasında aracın tamamen kontrol edilmesi mümkündür.

ENTEGRE TESTLER

- Tpms (lastik sensör kontrolü)
- Lastik profil tarama
- Jant analizi
- Far testi, Batarya kontrolü

CORGHI EXACT BLACKTECH PLUS

- Yüksek çözünürlüklü 8 adet Sony hassas kamera
- Kameraların pozisyonları daha önce programlanmış lift yüksekliğine hareket eder
- İhtiyaç duyulması durumunda kamera açıları manuel ayarlanabilir
- Run-Out özelliği ile tekerlek ve aks deformasyonlarını hesaplar
- Ayarlama sırasında anlık değişen değerleri aynı anda gösterebilir
- Opsiyonel Call One-Touch sistemi istendiğinde ön-arka düzen ayarlama işlemi sırasında ESP, Adaptif araç yüksekliği, dinamik direksiyon, elektronik direksiyon sistemi ve yön değiştiren far sistemine aracın ECU sistemine bağlanarak değişiklikleri tanıtır
- Ön-arka düzen ayarlamalarını kolaylaştıran videoları ve açıklamalar
- Opsiyonel İnfrared uzaktan kumanda •Pedal ve direksiyon kilitleme tertibatı •Printer



CORGHI EXACT LINEAR PLUS

- 2 yüksek çözünürlüklü kamera
- Geniş açıları görebilmesi sayesinde hatasız ölçüm
- 4 adet kırılmaz dayanıklı bağlantı ayağı ve yansıtıcı
 - Bağlantı ayakları janta zarar vermez
- Kolay ve hızlı kullanımlı arayüz •Hızlı ve hassas veri ölçümü
- Her türlü janta uyumlu veri okuma
- Lift ya da çukur modelleri •Türkçe menü ve türkçe raporlama



CORGHI ERCO XC5500 CT LT

- Döner Tablalı Makaslı Yavrulu Rot Lifti
- Maksimum Yük Kapasitesi 5,5 Ton
- Yavru Lift Yük Kapasitesi 4 Ton
- Minimum Yükseklik 165 mm
- Maksimum Yükseklik 2020+500 mm
- Lift Uzunluğu 4600 mm
- Lift Genişliği 2160 mm
- Elektronik Denge Kontrol Sistemi
- Lift Yüksekliği Ayarlanabilir Dijital Ekran

CORGHI ERCO HC4502 B

- İki Sütunlu Elektrohidrolik Lift
- Maksimum Yük Kapasitesi 4,5 Ton
- Minimum Yükseklik 95 mm
- Maksimum Lift Yüksekliği 2864 mm
- Maksimum Lift Kaldırma Yüksekliği 1850 mm
- İki Sütun arası İç Genişlik 2800 mm
- İki Sütun Dış Genişlik 3170 mm
- İki Sütun Dış Taban Genişliği 3521 mm



CORGHI MONSTER AG TT 14"-58"

- 14"-58" lastik ebadı
- Maksimum lastik çapı:2500mm
- Maksimum lastik genişliği:1600mm
- Maksimum lastik ağırlığı:1700-2500kg
- Üç devirli •Leveysiz sistem
- Standart kabloz kontrol ünitesi
- Otomatik dönen çampara ve gaga
- 1300kg makine ağırlığı
- Ebatlar:2400x2200x1800mm

CORGHI PROLINE 440 14"-56"

- Maks. tekerlek çapı 2300 mm
- Maks. tekerlek genişliği 1100 mm
- Damak Düşürme Kuvveti 28000N
- Jant Bağlantı Ayakları Kuvveti 44000N
- Maksimum tekerlek ağırlığı 1500Kg
- Çalışma Basıncı 150 Bar
- Motor Gücü Maks 3,2kW
- Makina Ağırlığı 980kg
- Makine Boyutları 2100 (max 2600) x 1900 x 1750mm
- OTOMATİK ÇAMPARA

