

7/tecnovac

MACCHINE CONFEZIONATRICI - PACKAGING MACHINES
PAKETLEME MAKİNELERİ



**ATHENA &
OLYMPIA**

TRAY SEALERS

TERMOSIGILLATRICI



ATHENA

OTOMATİK TABAK KAPAMA



SKIN PAKETLEME



İÇ KESİM



OLYMPIA

YARI OTOMATİK TABAK KAPAMA

ATHENA

Otomatik Tabak Kapama makinesi Athena, bu tür uygulamalar için tasarlanmış uyumlu tabaklar ve üst filmlerin herhangi bir kombinasyonu ile modifiye atmosfer teknolojisini de kullanarak paketlenme yeteneğine sahiptir.

Athena, güçlü paslanmaz çelik yapısı, kolay bakımı ve hijyen şartlarına uygunluğu sayesinde küçük ve orta ölçekli işletmeler için idealdir. Bu makinenin en önemli yönlerinden biri de yarı otomatik makine modeli Olympia'nın kalıplarını da kullanabilmesidir.



Kullanıcı paneli



IP 67 Koruma

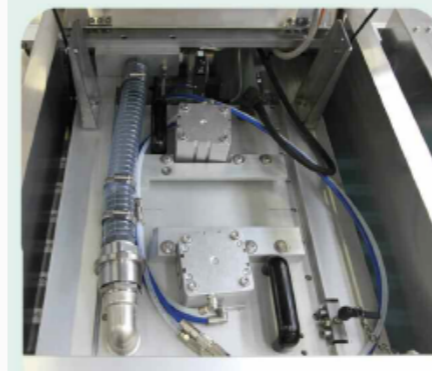

Kalıp detayı

KALIPLAR H120

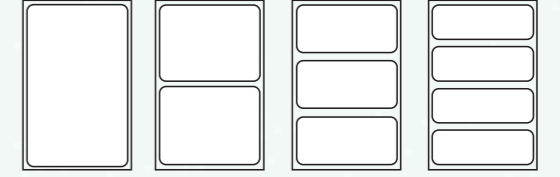

	1x1	1x2	1x3	1x4
ATHENA VG	287x424	201,5x287 287x209,5*	287x127	90,25x287 287x98,25**
ATHENA S	285x464	221,5x285 285x229,5*	285x140,5	100,25x285 285x108,25*

* eklemli kesme bıçakları
** eklemli kesme bıçakları 2 x 2

MAKİNE BOYUTLARI

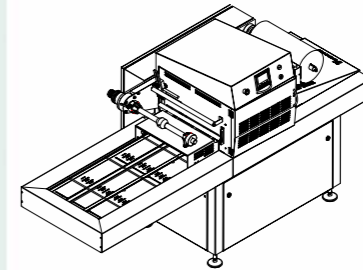
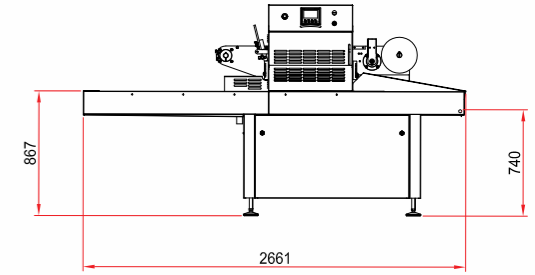
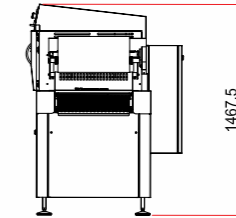

ATHENA XL

OTOMATİK TABAK KAPAMA



Dokunmatik kontrol paneli

KALIPLAR H120

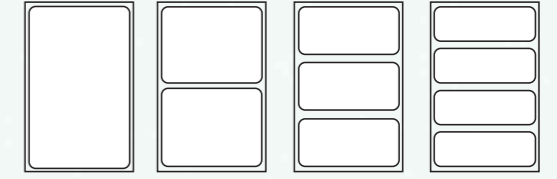

	1x1	1x2	1x3	1x4
ATHENA XL VG	357x424	357x201 357x209,5*	357x127	357x90,25 357x98,25**
ATHENA XL S	355x464	355x221,5 355x229,5*	355x140,6	355x100,25 355x108,25**

* eklemli kesme bıçakları
** eklemli kesme bıçakları 2 x 2



IP 67 koruma



Kalip detayı

ATHENA DUAL DRIVE

OTOMATİK TABAK KAPAMA



ATHENA DUAL DRIVE, tabak kapama alanında mutlak bir yeniliktir, tek bir makine ile Üretkenliği ve Esnekliği garanti edebilen entegre bir çözümdür. Yeni ATHENA DUAL DRIVE (birbirinden bağımsız iki kalıbı ve her kalıba adanmış birbirinden ayrı kaldırma ve film açma/toplama sistemi) tarafından sunulan çözüm, aşağıdaki performans iyileştirmelerini garanti edebilir:

ÇİFTE VERİMLİLİK

Birbirinin aynısı 2kalıp kullanılarak verimlilik artırılabilir. Aynı zamanda makine, atık filmin azaltılmasına izin verir (iki hazne arasındaki alanda atık film yoktur).

YÜKSEK ESNEKLİK

Makine, dönüşümlü çalışabilen iki ayrı çemberi sayesinde, iki farklı kalıp takımı ile tabakların kapatılmasına olanak sağlar. Her iki kalıp takımında Her iki kalıp takımı da sürekli olarak ısıtılmış halde tutulabilir, böylece her an kullanıma hazırdır.

SKIN + TABAK KAPAMA UYGULAMASI

Makine, Skin ve Standard Tabak Kapama uygulamasını manuel işlemler ve geçişler olmadan, sadece tepsiilerin makineye geçirilmesi ile gerçekleştirme imkanı sunar.

KALIPLAR H120

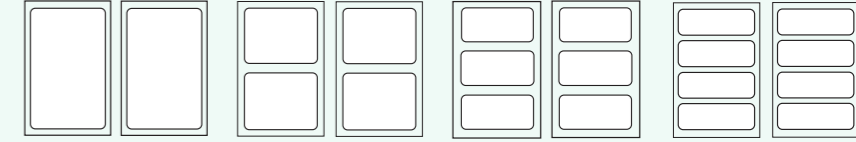

	2 x 1	2 x 2	2 x 3	2 x 4
ATHENA VG	2x287x424	2x201,5x287 2x287x209,5*	2x287x127	2x90,25x287 2x287x98,25**
ATHENA S	2x285x464	2x221,5x285 2x285x229,5*	2x285x140,5	2x100,25x285 2x285x108,25**

* eklemli kesme bıçakları

** eklemli kesme bıçakları 2 x 2

MAKİNE BOYUTLARI

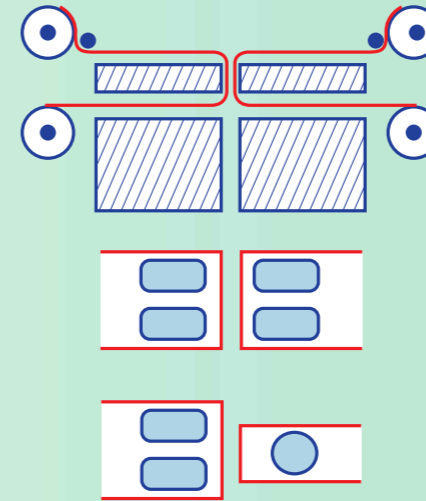
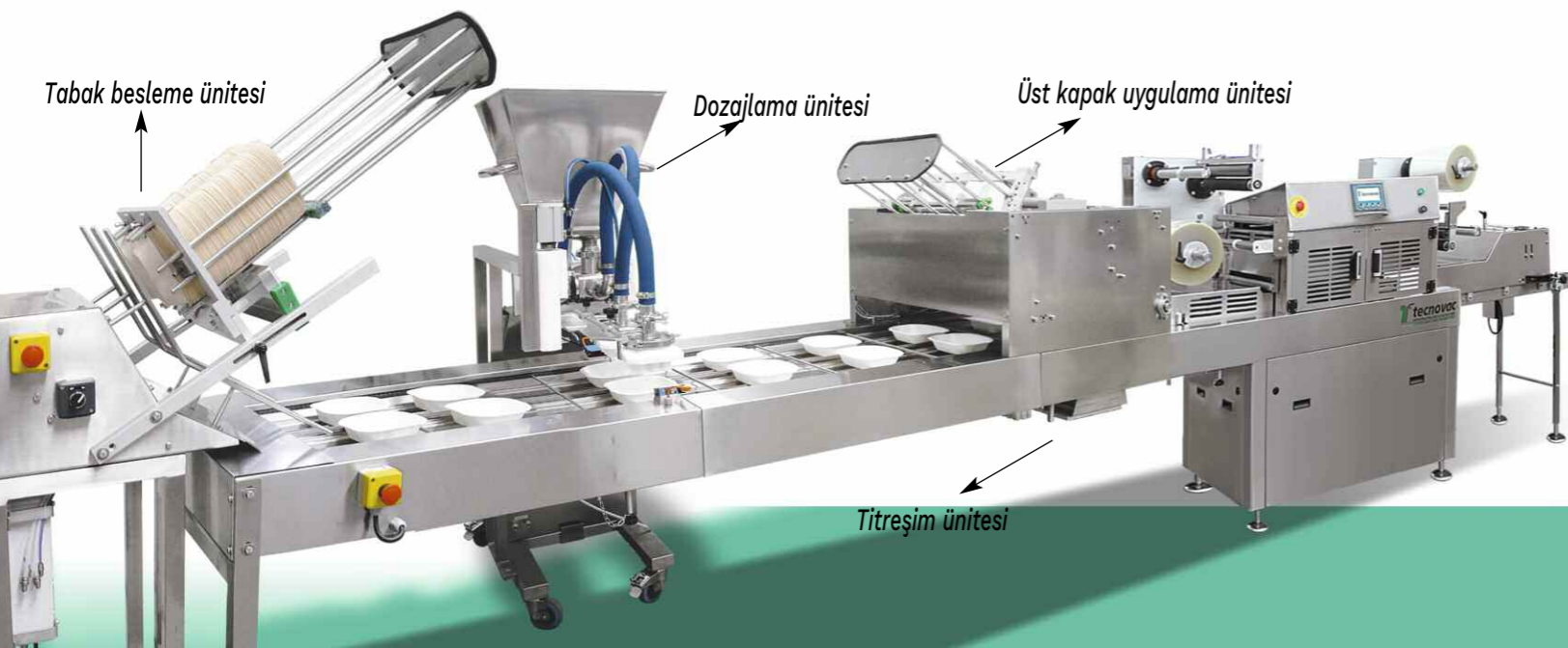
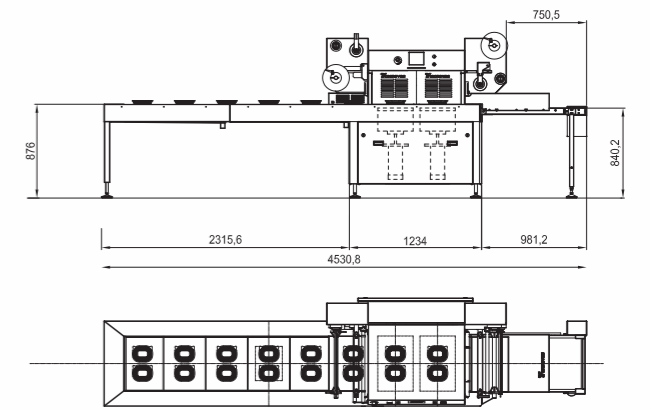
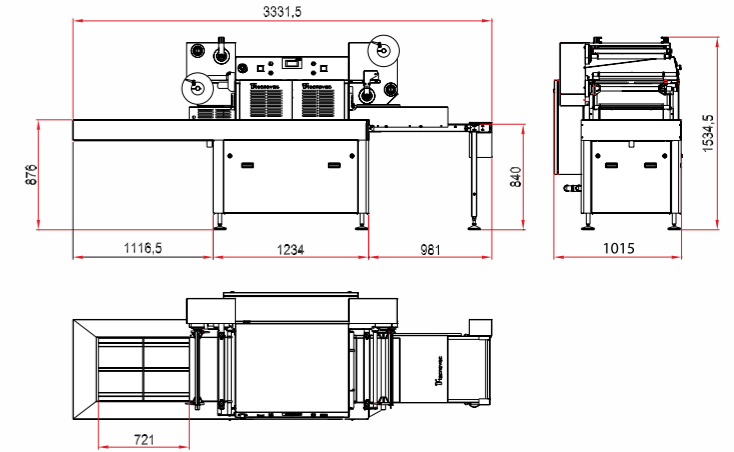

Üst film işleme sistemi

ATHENA H250

OTOMATİK TABAK KAPAMA



KALIPLAR H250

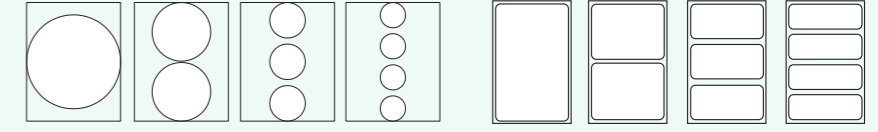

	1x1	1x2	1x3	1x4
ATHENA VG	357x424	357x201 357x209,5*	357x127	357x90,25 357x98,25**
ATHENA S	355x464	355x221,5 355x229,5*	355x140,6	355x100,25 355x108,25**

* eklemli kesme bıçakları
** eklemli kesme bıçakları 2 x 2

MAKİNE BOYUTLARI

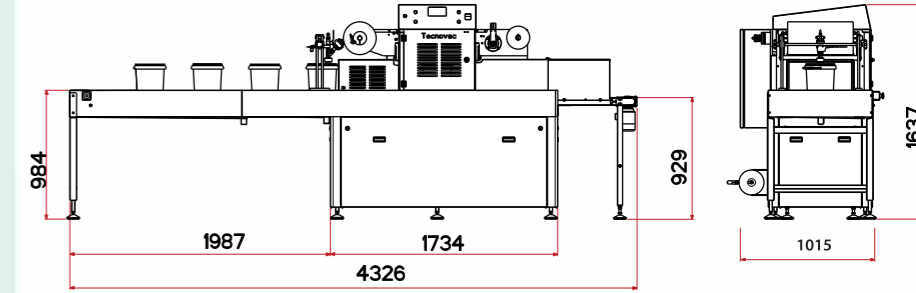

Konsol ayrıntısı



Dozajlama ünitesi örneği

Makine modeli	ATHENA	ATHENA XL	ATHENA Dual Drive	ATHENA H250
Makine boyutları	2674,5x1015x1402(y) mm	2674,5x1015x1402(y) mm	3331,5x1015x1534,5(y) mm	4326x1015x1637(y) mm
Yükleme bölgesi uzunluğu	750 mm	750 mm	900 mm	1987 mm
Çalışma yüksekliği	900 mm	900 mm	900 mm	984 mm
Yaklaşık ağırlık	600 kg	650 kg	800 kg	700 kg
Üretim hızı (...'a kadar)	15 döngü/dak.	15 döngü/dak.	15 döngü/dak.	15 döngü/dak.
Maksimum film genişliği, maksimum rulo dış ve maksimum rulo iç çapı	480/250/76 mm	480/250/76 mm	480/250/76 mm	480/250/76 mm
Vakum pompası ve dijital vakum ölçer *	100 m ³ /saat*	100 m ³ /saat*	200 m ³ /saat* harici	100 m ³ /saat*
Rezerv tanklı gaz üfleme düzeneği	standart	standart	standart	standart
Programlanabilir 10 reçete hafızası	standart	standart	standart	standart
Basınçlı hava gereksinimi **	160 - 500 NI/dak. 6 bar**	160 - 500 NI/dak. 6 bar**	300 - 900 NI/dak. 6 bar**	400 NI/dak. 6 bar**
Enerji gereksinimi	400V trifaze, 50 Hz nötr ve toprak TN-S	400V trifaze, 50 Hz nötr ve toprak TN-S	400V trifaze, 50 Hz nötr ve toprak TN-S	400V trifaze, 50 Hz nötr ve toprak TN-S
Güç tüketimi (...'a kadar)	4,5 Kw maks.	5,3 Kw maks.	9 Kw maks.	5,5 Kw maks.

Kullanılabilir materyaller: önceden şekillendirilmiş yapıstabil tabaklar tek veya iki bileşenli, lamine, köpük, karton ve sızdırmaz tabakalı alüminyum.

OLYMPIA

YARI OTOMATİK TABAK KAPAMA MAKİNESİ



OPSİYONEL: Tabakların kaldırılması için pnömomatik çekmece



OLYMPIA H 250

Otomatik film açma ve artık sarma

KALIPLAR H140

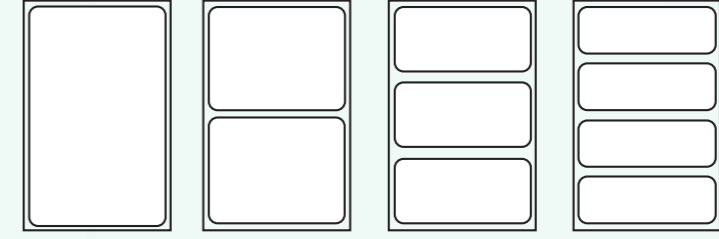

	1 CAV.	2 CAV.	3 CAV.	4 CAV.
OLYMPIA VG/S manuel/el ile işletim	275x424	275x201,5 127x424	275x127,35 77,5x424	275x90,25 127x201,5
OLYMPIA VG/S otomatik film üniteli	266x457	266x218 122,5x457	266x138,35	266x98,52 122,5x218

* eklemli kesme bıçakları
** eklemli kesme bıçakları 2 x 2

OLYMPIA basic



OLYMPIA

Makine modeli	OLYMPIA BASIC	OLYMPIA otomatik film açma artık sarma	OLYMPIA H250
Makine boyutları	587x851x1326 (y) mm	728x935x1575 (y) mm	728x935x1675 (y) mm
Çalışma yüksekliği	880 mm	880 mm	975 mm
Yaklaşık ağırlık	200 kg	230 kg	250 kg
Üretim hızı (...'a kadar)	5 döngü/dak.	5 döngü/dak.	5 döngü/dak.
Maksimum film genişliği, maksimum rulo dış ve maksimum rulo iç çapı	480/15 Kg	310/250/76 mm	310/250/76 mm
Vakum pompası ve dijital vakum ölçer *	40/60 m³/saat*	40/60 m³/saat*	40/60 m³/saat*
Programlanabilir 10 reçete hafızası	standart	standart	standart
Basınçlı hava gereksinimi **	2 NI/döngü 6 bar**	2 NI/döngü 6 bar**	2 NI/döngü 6 bar**
Enerji gereksinimi	400V trifaze, 50 Hz toprak ve nötr TN-S	400V trifaze, 50 Hz toprak ve nötr TN-S	400V trifaze, 50 Hz toprak ve nötr TN-S
Güç tüketimi (...'a kadar)	2,5 Kw maks.	2,5 Kw maks.	2,5 Kw maks.

Kullanılabilir materyaller: önceden şekillendirilmiş yapıstınlabılır tabaklar tek veya iki bileşenli, lamine, köpük, karton ve sızdırmaz tabakalı alüminyum.

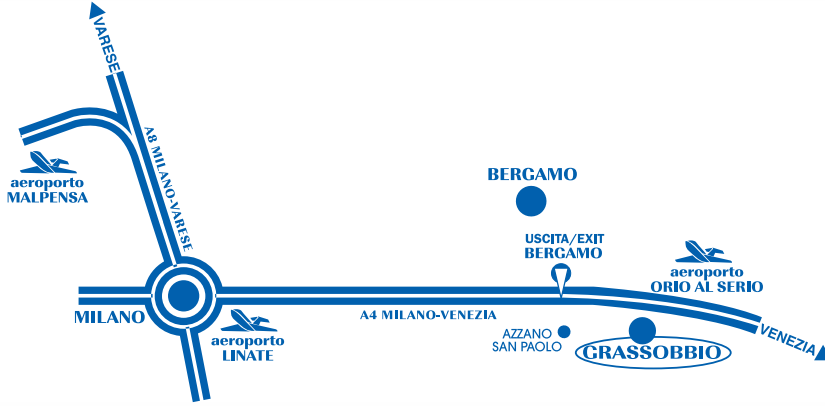

HEADQUARTER

Via Padre Elzi, 28/C
24050 GRASSOBBIO (BG)
ITALY

Tel. (+39) 035 3846801/02/03 - (+39) 035 534074
Fax (+39) 035 534076



INOPACK PAKETLEME MALZEMELERİ ve TİCARET LTD.ŞTİ.

Küçükbakkalköy Mah. Dereboyu Cad. No: 3A
Brandium R5 Blok Kat: 7 D: 44 34750

Ataşehir / İstanbul

Tel: +90 216 807 17 70 Faks: +90 216 807 17 80

INOPACK

info@inopack.com.tr - www.inopack.com.tr