

## ALM-01 COTTON SWAB MACHINE

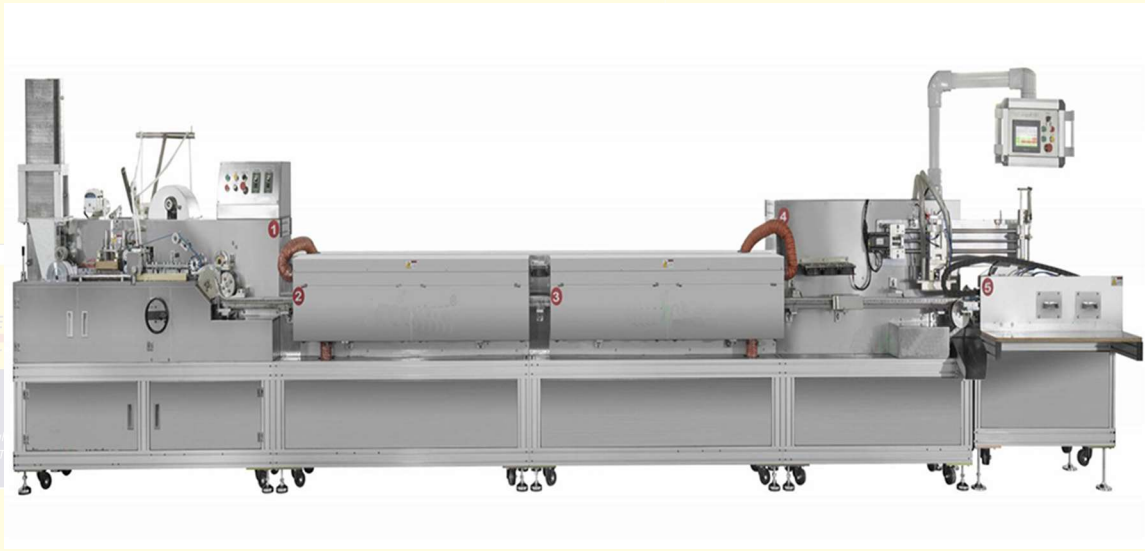

All of our cotton swab machine are including making, drying unit and packing unit in same machine.

**Shape of tip (swab head) samples: a machine included 1set mould already. Other shape of mould need to buy.**



Final products samples: a machine included 1set packing table already. Other packing methods need to buy.



Zipper Bag



Round Can



Square Box



**Remark: : Other packaging methods need to be customized.**

**I. Main Technology parameter:**

<b>Max. speed</b>	1200pcs/min
<b>Total power</b>	13kw, 380v 3phase 50hz
<b>Power consumption</b>	7--8kw/hour
<b>Rate of spoiled</b>	0.5%
<b>Suitable Stick size</b>	length 70mm (±1mm) diameter: 2.3—2.5mm
<b>Suitable stick</b>	plastic stick, paper , wooden , bamboo stick (need change the machine parts)
<b>Type of swab</b>	single head double head
<b>Suitable Cotton sliver</b>	1.5gram/meter (according to the size of tip)
<b>Size</b>	7806 x 940 x1790mm
<b>Weight</b>	1.8 tons

**II. Machine details: ALM-01**

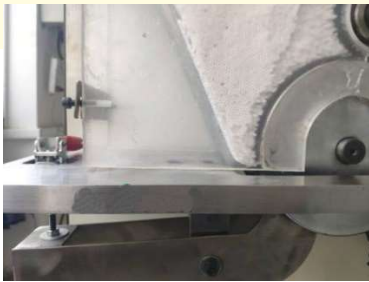
① Details list:

Name	Picture	CS-01
Lifter		
Frame		Iron with paint (will rust after many years)

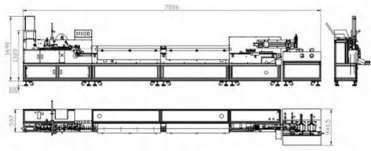
<b>Electrical &amp; Pneumatic parts</b>		Omron, Airtac
<b>Machine Length</b>		

② Electrical & Pneumatic parts list: the different of CS-01

Machine model		CS-01	
No.	Name	Brand	Picture
1	PLC	Japan OMRON	
2	Touch Screen	Taiwan Weinview	
3	Servo motor Servo drive	Taiwan Delta	
4	Temperature Controller	Japan RKC	
5	Inverter	Taiwan Delta	
6	Solenoid valve	Taiwan AirTac	
7	Air cylinder	Taiwan AirTac	



<b>8</b>	Filter	Taiwan AirTac	
<b>9</b>	Magnetic switch	Taiwan AirTac	
<b>10</b>	Hand rotary valve	Taiwan AirTac	
<b>11</b>	Solid state relay	China Aoyi	

**III. Quotation: FOB shanghai or ningbo**

No.	Item	Model	Quantity	Unit price
<b>1)</b>	Cotton Swab Machine	CS-01	1 set	USD21000/set

**Remark: The offer included 1 set mould and 1 packing table already.**





2) Extra Mould Price: change mould to produce different shape of swab head.

Name	Picture	Price	Remake
Common swab		300USD (2 pcs)	brass material mould. Service life: 3--5years
Baby safety swab		350USD (2 pcs)	brass material mould. Service life: 3--5years ( need add one gear )
Cosmetic swab (taper)		300USD (2 pcs)	brass material mould. Service life: 3--5years

Cosmetic swab (spiral)		300USD (2 pcs)	brass material mould. Service life: 3--5years
---------------------------	---	-------------------	--

Extra Packing Unit: through change packing table can pack swabs in different container.  
(a machine included one set packing table already)

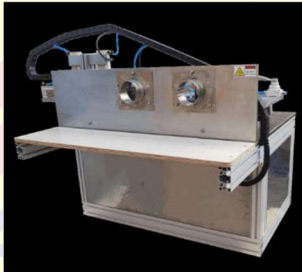
3) Extra packing table price:

CS-01		
Packaging type	Picture	Price
Zipper bag 		2,000 USD
Round can 		2,000 USD
Square box 		1,500 USD

5)About the stick material :

- Plastic stick

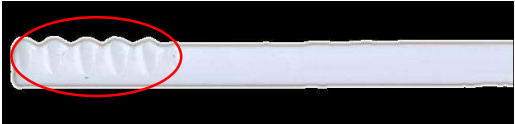
	<p><b>Notch Heater</b>  this parts is use for make notch on the both end side of plastic stick. ( included already )</p>  <p>( to wind the cotton on stick strong )</p>
---	---

-Paper stick ,bamboo stick, wooden stick: 1000USD (optional)

this parts is use for roll the glue on the paper, bamboo, wooden stick.

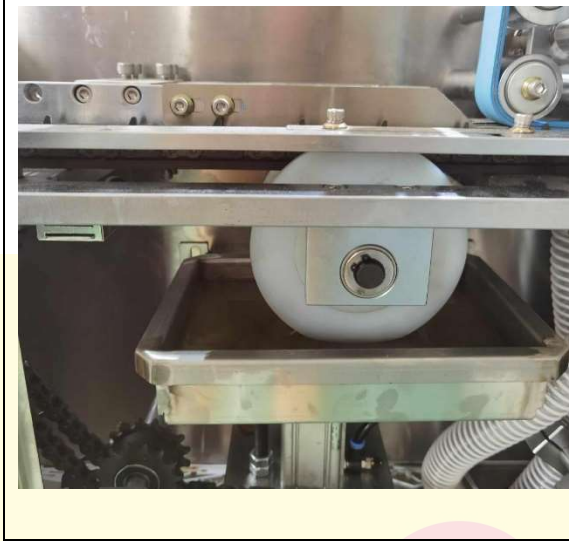

If you want to produce plastic stick,paper stick, wooden stick, bamboo stick by one machine, we will set 2 types system in PLC, you just choose the system and change the full set of parts: (mechanical parts, plastic wheel, glue tray, motor)

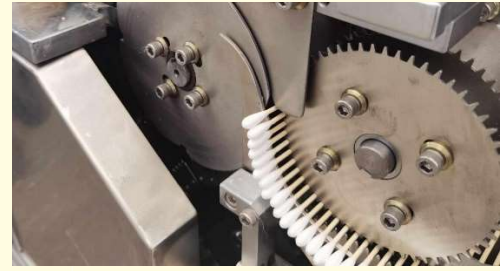

#### IV. Machine pictures:

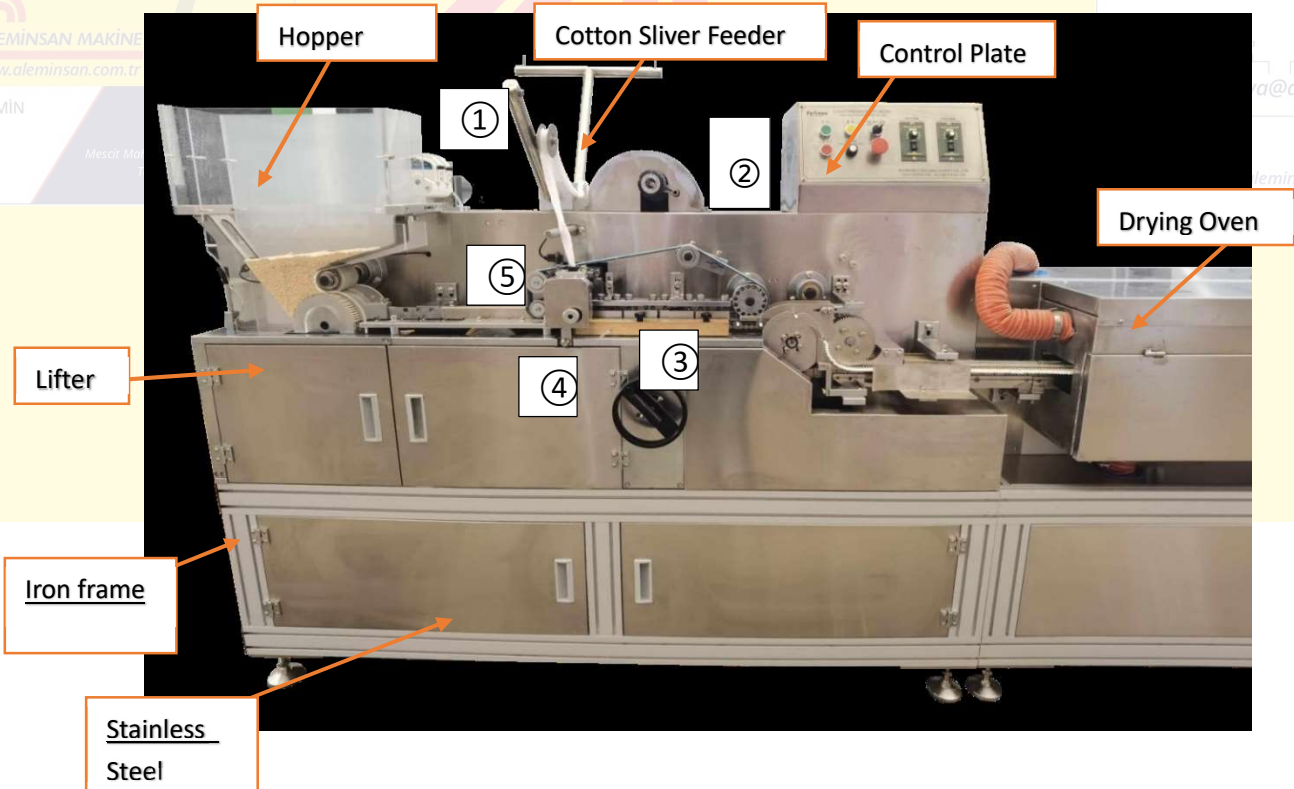

①Glue pump : feeding glue to mould automatically.

②Tip (swab head) size controller : adjust the size of tip.(Mark: machine must be working,then adjust it.)

③Notch maker / inner glue feeder: make the notch on the both end of plastic stick. Or

feeding glue on the paper, wooden, bamboo stick.

④ Cotton pulling and cutting device

⑤ Mould: change mould to produce different shape of swab.



CS-01: Iron with paint (will rust after many years)



**Hopper**

Fill the stick in this  
hopper, then set the

**Lifter**

**Stick Dimension**

Diameter: 2.3-2.5mm

Length:  $70 \pm 2$ mm

**Sensor**

The machine will stop  
working automatic when

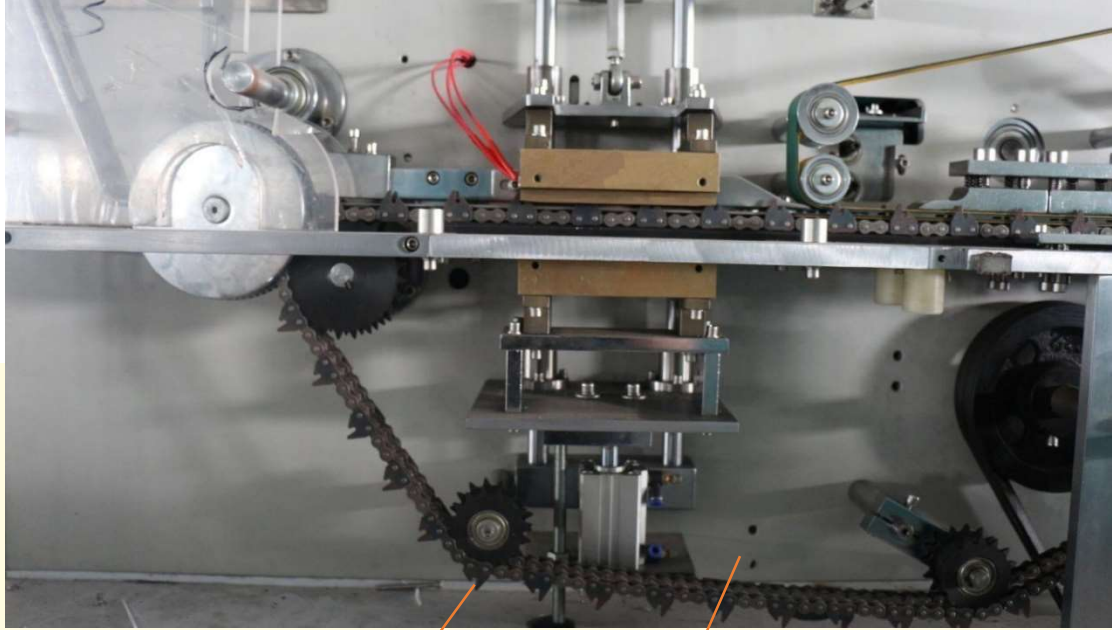

Transport stick by chain.  
No easy to wear.

This is CS-01:  
Iron with white color  
paint.

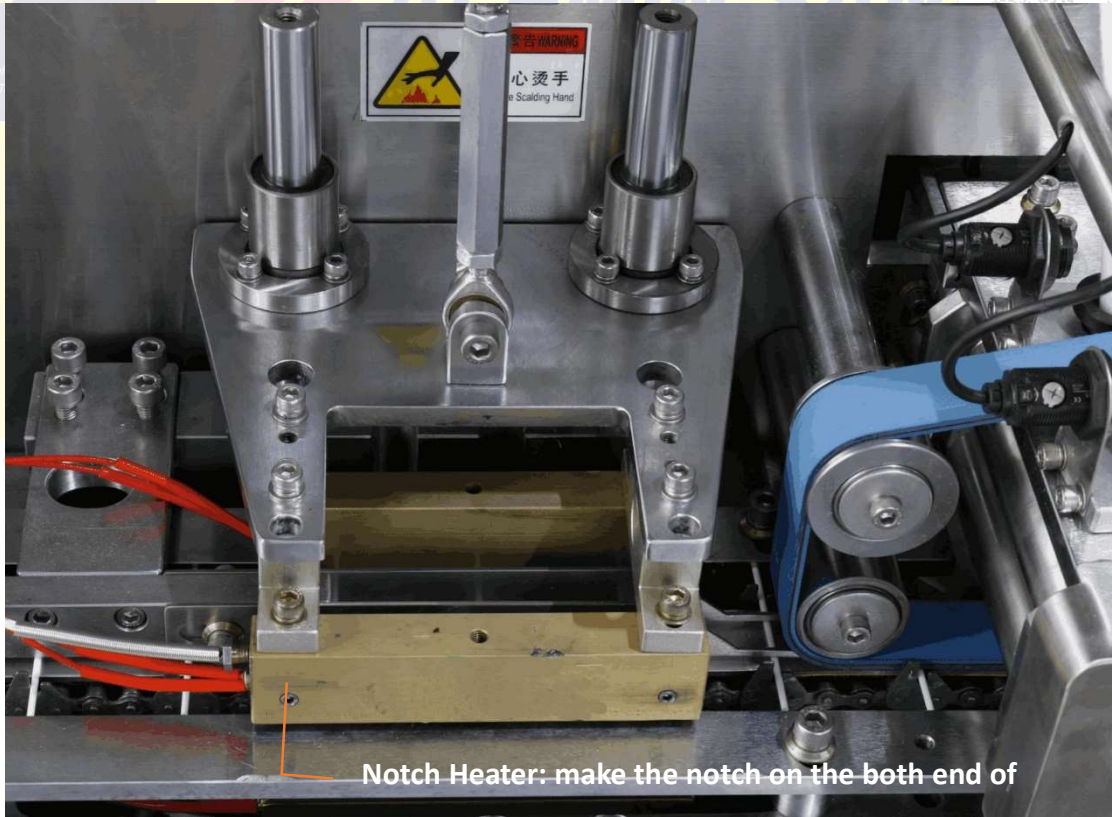

Notch Heater: make the notch on the both end of



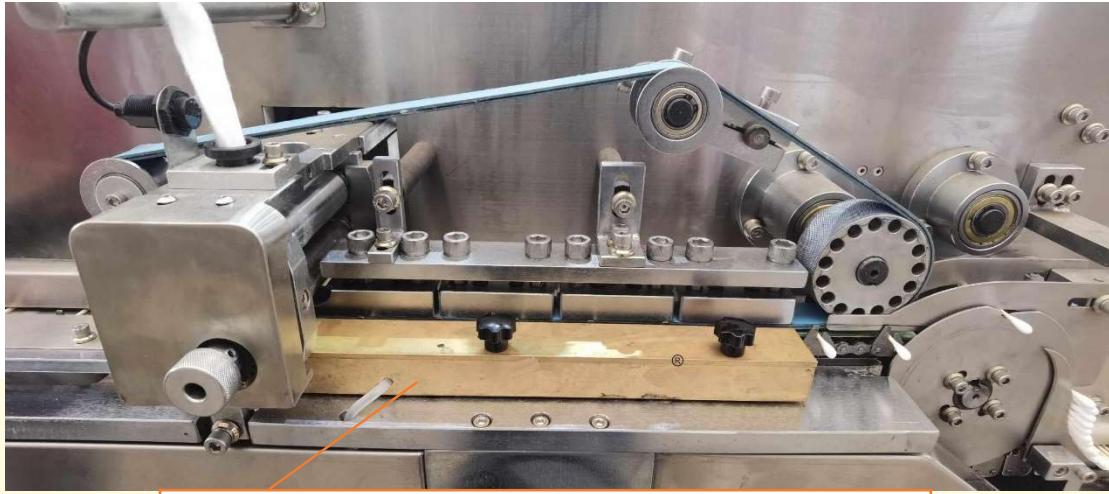

Mould: change mould to produce different shape of tip by one machine

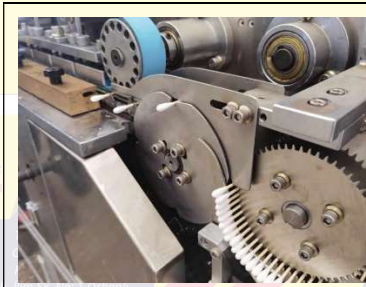

**Common Swab**  
(adopt 1.5-2.0g/m cotton sliver)



**Baby Safety Swab**  
(adopt 5-6g/m cotton sliver)



**Cosmetic Swab**  
(adopt 1.5-2.0g/m cotton sliver)

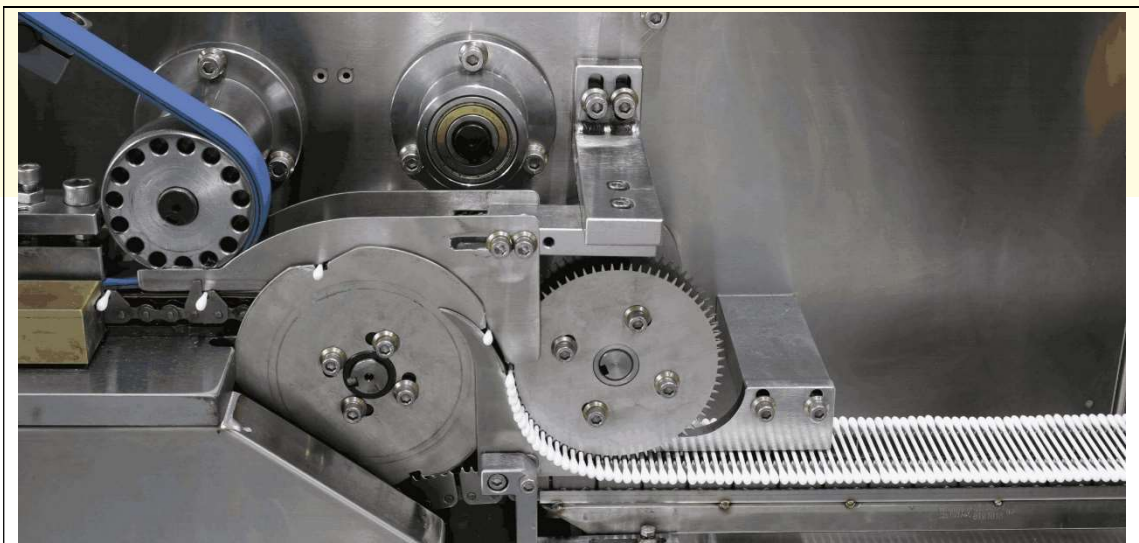

Transport the cotton swab from mould to drying chain smoothly.

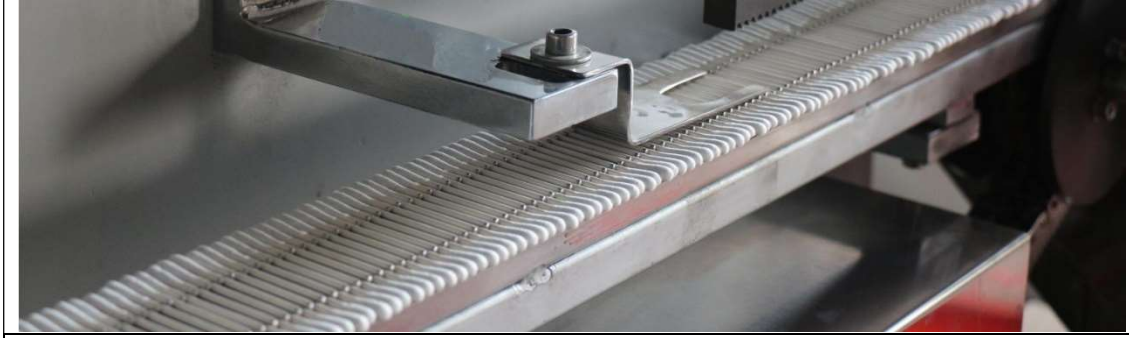

The drying chain sending the swabs to drying oven.

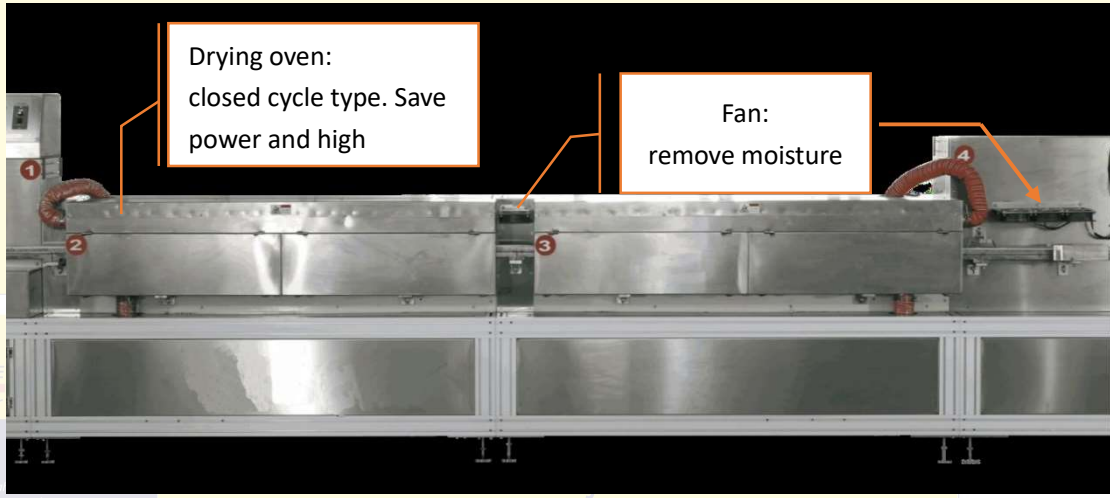

Fan:  
remove moisture

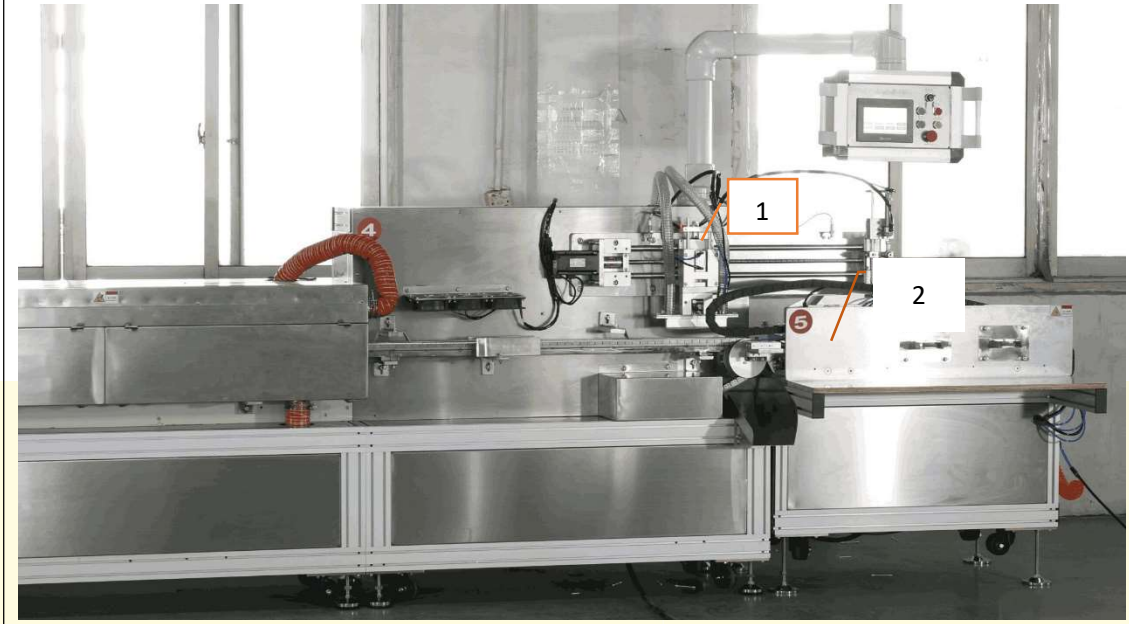

1. suction: after dried, then transport the cotton swab to packing table by suction automatically.  
2. Packing table: through change packing table you can pack swab in different container: zipper bag, round can, square box and others.  
CS-01: adopt Taiwan "Airtac" pneumatic parts.

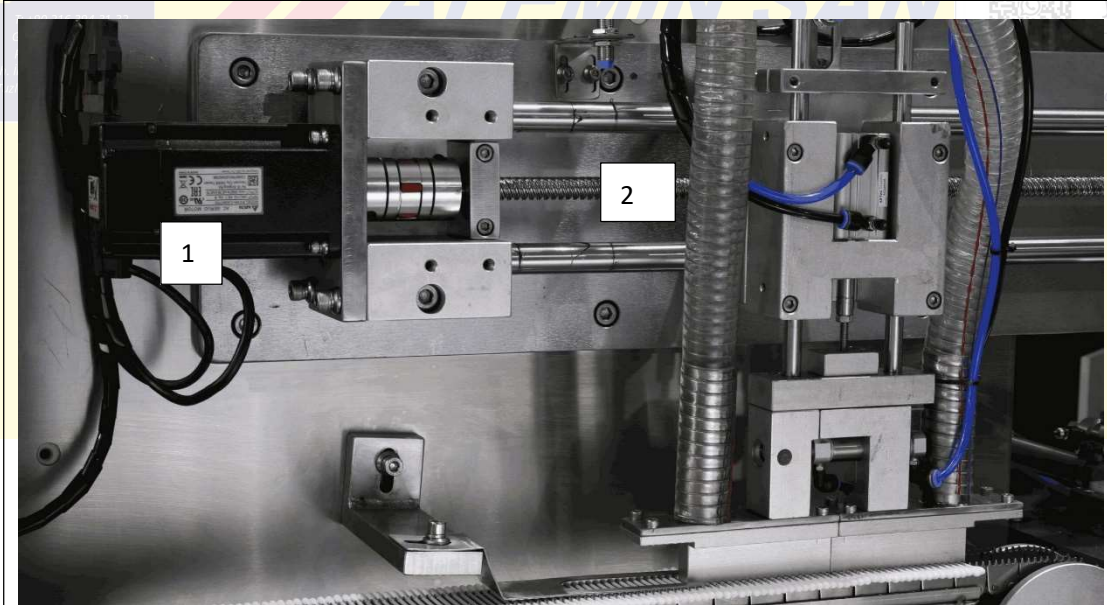

- 1 Servo motor: :  
CS-01 adopt Taiwan "Delta" brand servo motor.  
2 Screw: :  
Adopt Taiwan "HIWIN" or "TBI" brand.

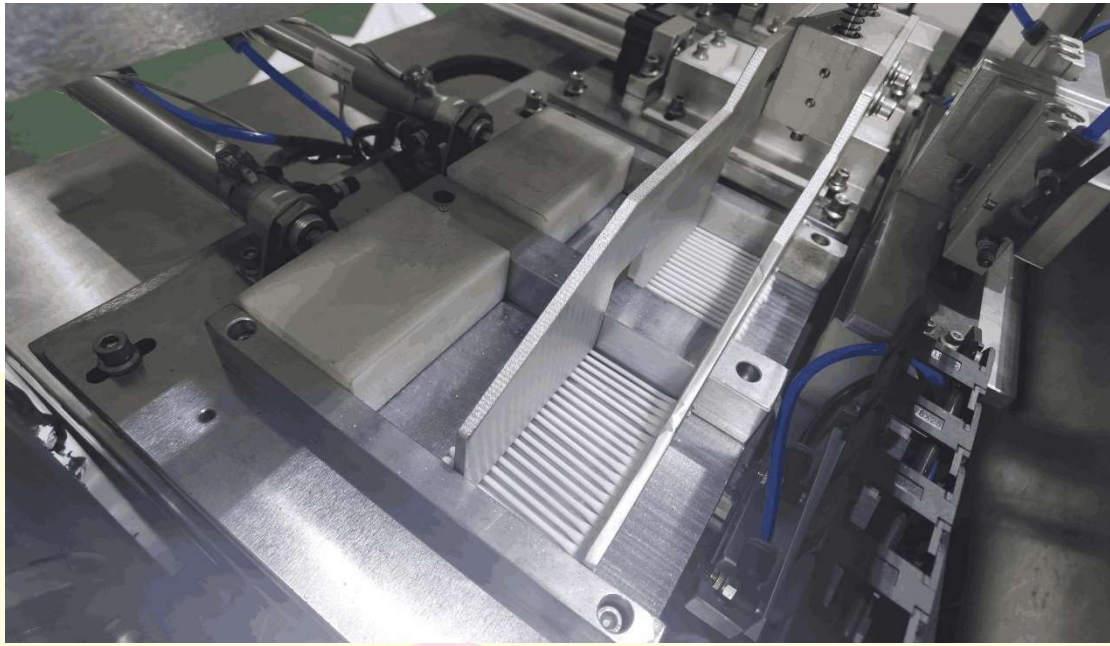

The suction will put and gather swab at here of packing table.

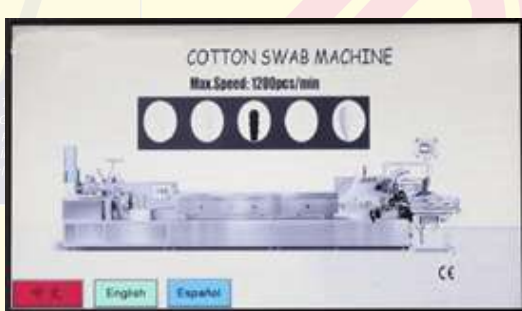

**Touch Screen**

We have set 2 languages in it already: Chinese, English  
 If you want your language, just let us know.  
 We will translate and set it on.

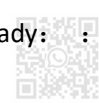

ber website  
 ya@aleminsan.com.tr  
 e-mail  
 www.aleminsan.com.tr

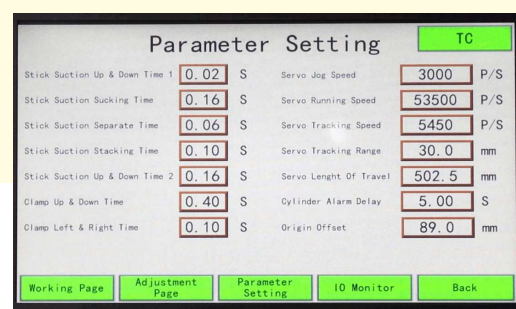
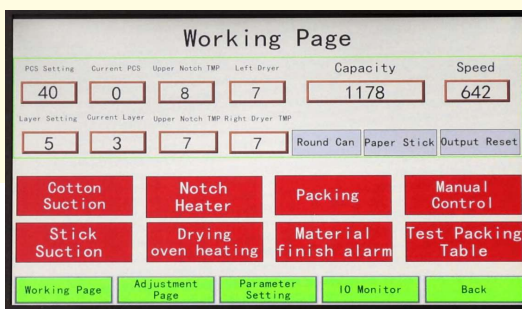

It is easy to operate machine

**Packing and shipment: packed by wooden case**

	
<b>Main Machine</b> Size: 1960*840*1650mm GW: 640KG	<b>Drying Oven</b> Size: 1970*1460*1290mm GW: 615KG
	
<b>Suction Unit</b> Size:1970*770*2050mm GW: 434KG	<b>Packing Table</b> Size:1120*1160*1120mm GW: 350KG

**V. Payment term and delivery time**

1. **Terms of Payment:** 50% of total price as down-payment, 50% of total price shall be paid before delivery, by T/T or L/C.
2. **Test:** Raw material provided by the buyer
3. **Delivery time:** 30 days from down payment receipt
4. **Inspection:** The seller sends notice to the buyer in advance to come to the seller's factory for training and inspection equipment
5. **Packaging:** Polywood package for ocean transportation.
6. **Validity of Quotation:** 30 days.
7. **Warranty:** 12 months from the date of shipment