



## Type VDSRL sequence valves

- Direct acting

Technical specifications and diagrams are measured with mineral oil of 46 cSt viscosity at 40°C (104°F) temperature.

	VDSRL 3-14	VDSRL 5-38 VDSRL 5Y-38	VDSRL 5-12 VDSRL 5Y-12	VDSRL 10-12	VDSRL 10-34	VDSRL 20-34	
Nominal flow	10 l/min (2.6 US gpm)	25 l/min (6.6 US gpm)	35 l/min (9.2 US gpm)	50 l/min (13.2 US gpm)	70 l/min (18.5 US gpm)	120 l/min (31.7 US gpm)	
Max. pressure	Aluminium body = 210 bar (3050 psi) Steel body = 350 bar (5100 psi)						
Fluid	mineral based oil						
Viscosity	from 10 to 200 cSt						
Max. level of contamination	18/16/13 ISO4406						
Fluid temperature	with NBR seals from -20°C (-4°F) to 80°C (176°F)						
Environmental temp. for working conditions	from -40°C (-40°F) to 100°C (212°F)						
Weight	alum.	0.48 kg (1.06 lb)	0.63 kg (1.39 lb)	0.67 kg (1.48 lb)	1 kg (2.20 lb)	1.10 kg (2.42 lb)	1.80 kg (3.97 lb)
	steel	1.08 kg (2.38 lb)	1.49 kg (3.28 lb)	1.54 kg (3.40 lb)	2.15 kg (4.74 lb)	2.13 kg (4.70 lb)	4 kg (8.82 lb)

NOTE - For different conditions, please contact Walvoil Sales Dpt.

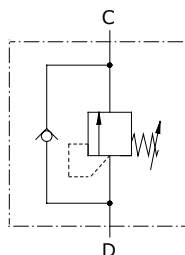

### Dimensions

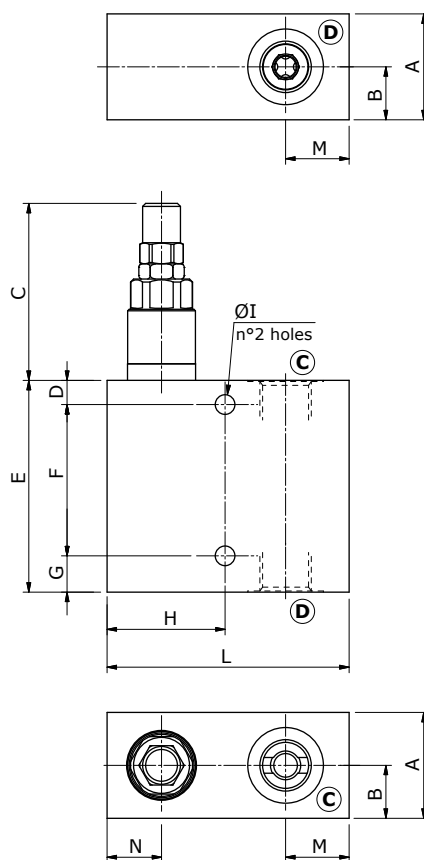

Valve type	All ports
VDSRL 3-14	G1/4
VDSRL 5-38 VDSRL 5Y-38	G3/8
VDSRL 5-12 VDSRL 5Y-12	G1/2
VDSRL 10-12	G1/2
VDSRL 10-34	G3/4
VDSRL 20-34	G3/4

Dimensions are in mm-in

Valve type	A	B	C	D	E	F	G	ØI	H	L	M	N
VDSRL 3-14	30-1.18	15-0.59	53-2.09	7-0.27	70-2.75	50-1.97	13-0.51	6.5-0.25	34-1.34	65-2.56	15-0.59	15-0.59
VDSRL 5-38 VDSRL 5Y-38	35-1.38	17.5-0.69	60-1.36	8-0.31	70-2.75	50-1.97	12-0.47	6.5-0.25	39-1.53	80-3.15	21-0.83	18-0.71
VDSRL 5-12 VDSRL 5Y-12	35-1.38	17.5-0.69	60-1.36	8-0.31	75-2.95	55-2.16	12-0.47	8.5-0.33	39-1.53	80-3.15	21-0.83	18-0.71
VDSRL 10-12	40-1.57	20-0.79	67-2.64	8-0.31	80-3.15	60-2.36	12-0.47	8.5-0.33	44-1.73	90-3.54	24-0.94	20-0.79
VDSRL 10-34	40-1.57	20-0.79	67-2.64	8-0.31	90-3.54	70-2.75	12-0.47	8.5-0.33	44-1.73	95-3.74	27-1.06	20-0.79
VDSRL 20-34	50-1.97	25-0.98	76.5-3.01	8-0.31	100-3.94	80-3.15	12-0.47	8.5-0.33	53-2.09	110-4.33	32-1.26	25-0.98

**Ordering codes and description composition**

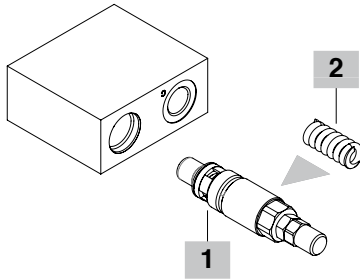
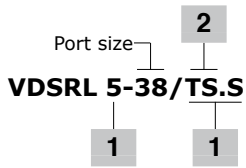

**VDSRL complete valves**

*With direct acting valve type: standard setting is referred to 5 l/min (1.32 US gpm)*

TYPE	CODE	DESCRIPTION
<b>Configuration with G1/4 ports</b>		
<b>VDSRL 03-14/TS.S</b>	1200011102	Aluminium body, setting range 50-200 bar (725-2900 psi) Standard setting 160 bar (2300 psi)
<b>VDSRL 03-14/TS.S/ac</b>	1200012100	Steel body, as previous one
<b>Configuration with G3/8 ports</b>		
<b>VDSRL 5-38/TS.S</b>	1200021102	Aluminium body, setting range 50-220 bar (725-3200 psi) Standard setting 160 bar (2300 psi)
<b>VDSRL 5-38/TS.S/ac</b>	1200022102	Steel body, as previous one
<b>VDSRL 5Y-38/TS.S</b>	1200021112	Aluminium body, setting range 140-190 bar (2030-2750 psi) Standard setting 150 bar (2200 psi)
<b>Configuration with G1/2 ports</b>		
<b>VDSRL 5-12/TS.S</b>	1200021152	Aluminium body, setting range 50-220 bar (725-3200 psi) Standard setting 160 bar (2300 psi)
<b>VDSRL 5-12/TS.S/ac</b>	1200022150	Steel body, as previous one
<b>VDSRL 10-12/TS.S</b>	1200031102	Aluminium body, setting range 50-220 bar (725-3200 psi) Standard setting 160 bar (2300 psi)
<b>VDSRL 10-12/TS.S/ac</b>	1200032100	Steel body, as previous one
<b>Configuration with G3/4 ports</b>		
<b>VDSRL 10-34/TS.S</b>	1200031152	Aluminium body, setting range 50-220 bar (725-3200 psi) Standard setting 160 bar (2300 psi)
<b>VDSRL 10-34/TS.S/ac</b>	1200032100	Steel body, as previous one
<b>VDSRL 20-34/TS.S</b>	1200041102	Aluminium body, setting range 50-220 bar (725-3200 psi) Standard setting 160 bar (2300 psi)
<b>VDSRL 20-34/TS.S/ac</b>	1200042100	Steel body, as previous one

For other steel body configurations, SAE thread and configurations with FPM (Viton) seals please contact our Sales Dpt.

**1 Direct acting pressure relief valves**

*Standard setting 160 bar at 5 l/min (2300 psi at 1.32 US gpm)*

TYPE	CODE	DESCRIPTION
<b>For G1/4 ports configuration</b>		
<b>MC08A/0S2B</b>	0MC08002000	Setting range 50-200 bar (725-2900 psi) Standard setting 160 bar (2300 psi)
<b>For G3/8 ports configuration</b>		
<b>VMP 5/TS.S</b>	1100520408	Setting range 50-220 bar (725-3200 psi) Standard setting 160 bar (2300 psi)
<b>VMP 5Y/TS.S</b>	1100520406	Setting range 140-190 bar (2030-2750 psi) Standard setting 150 bar (2200 psi)
<b>For G1/2 ports configuration</b>		
<b>VMP 5/TS.S</b>	1100520408	Setting range 50-220 bar (725-3200 psi) Standard setting 160 bar (2300 psi)
<b>VMP 5Y/TS.S</b>	1100520406	Setting range 140-190 bar (2030-2750 psi) Standard setting 150 bar (2200 psi)
<b>VMP 10/TS.S</b>	1100530400	Setting range 50-220 bar (725-3200 psi) Standard setting 160 bar (2300 psi)
<b>For G3/4 ports configuration</b>		
<b>VMP 10/TS.S</b>	1100530400	Setting range 50-220 bar (725-3200 psi) Standard setting 160 bar (2300 psi)
<b>VMP 20/TS.S</b>	1100540400	Setting range 50-220 bar (725-3200 psi) Standard setting 160 bar (2300 psi)

**2 Pressure setting springs**

TYPE	CODE	DESCRIPTION
<b>For MC08A valve</b>		
<b>TB</b>	3ML1092500	Setting range 5-50 bar (72.5-725 psi)
<b>TS</b>	3ML1092501	Setting range 50-200 bar (725-2900 psi)
<b>TR</b>	3ML1092502	Setting range 150-350 bar (2175-5075 psi)
<b>For VMP 5 valve</b>		
<b>TB</b>	3MOL314311	Setting range 5-40 bar (72.5-580 psi)
<b>TV</b>	3MOL314330	Setting range 20-80 bar (290-1150 psi)
<b>TS</b>	3MOL315330	Setting range 50-220 bar (725-3200 psi)
<b>TR</b>	3ML1143600	Setting range 180-350 bar (2600-5100 psi)
<b>For VMP 5Y valve</b>		
<b>TB</b>	3MOL314311	Setting range 5-80 bar (72.5-1150 psi)
<b>TV</b>	3MOL314330	Setting range 40-150 bar (580-2200 psi)
<b>TS</b>	3ML1143400	Setting range 140-190 bar (2050-2750 psi)
<b>TR</b>	3MOL315330	Setting range 180-350 bar (2600-5075 psi)
<b>For VMP 10 valve</b>		
<b>TB</b>	3MOL316410	Setting range 5-40 bar (72.5-580 psi)
<b>TV</b>	3ML1154300	Setting range 20-80 bar (290-1150 psi)
<b>TS</b>	3MOL317420	Setting range 50-220 bar (725-3200 psi)
<b>TR</b>	3MOL317440	Setting range 180-350 bar (2600-5100 psi)
<b>For VMP 20 valve</b>		
<b>TB</b>	3ML1184300	Setting range 5-40 bar (72.5-580 psi)
<b>TV</b>	3ML1174500	Setting range 20-80 bar (290-1150 psi)
<b>TS</b>	3ML1204200	Setting range 50-220 bar (725-3200 psi)
<b>TR</b>	3ML1214500	Setting range 180-350 bar (2600-5100 psi)

Rating diagrams

**VDSRL 03-14 pressure vs. flow**  
Std. setting at 5 l/min (1.32 US gpm)

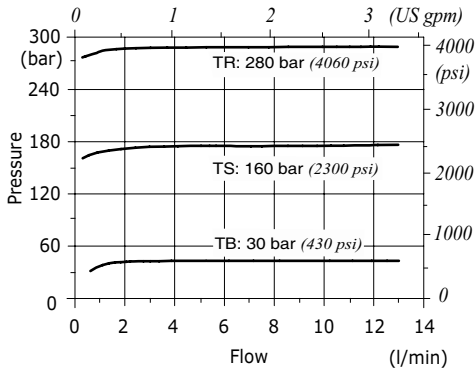

**VDSRL 5 (38-12) pressure vs. flow**  
Std. setting at 5 l/min (1.32 US gpm)

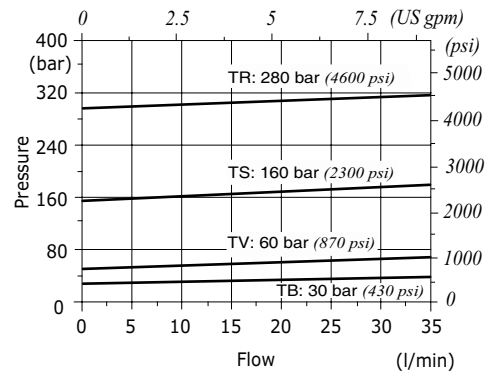

**VDSRL 5Y (38-12) pressure vs. flow**  
Std. setting at 5 l/min (1.32 US gpm)

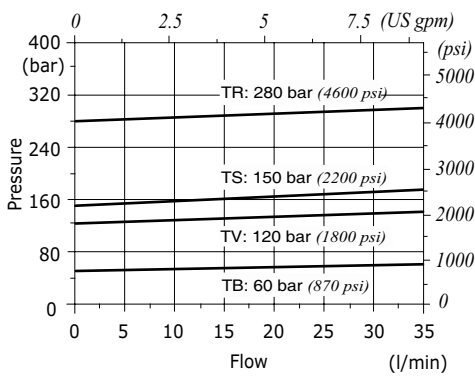

**VDSRL 10 (12-34) pressure vs. flow**  
Std. setting at 5 l/min (1.32 US gpm)

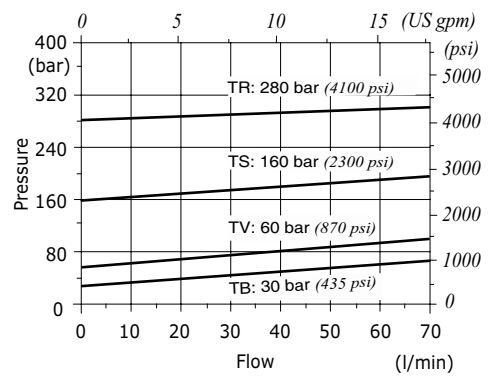

**VDSRL 20-34 pressure drop vs. flow**  
Std. setting at 5 l/min (1.32 US gpm)

