

Kalite Politikamız

Quality Policy

Kaliteli hizmet ve kaliteli ürün ilkelerini benimseyen ve bu ilkeleri taviz vermeksizin hayata geçiren Beka Endüstriyel Mutfak; müşteri memnuniyeti odaklı kalite politikasını benimsemiştir.

KALİTE POLİTİKAMIZ

1. Kaliteyi doğru tanımlamak:
**Kalite, bir yaşam tarzıdır.*
**Hepimizin görevidir.*
**Müşterilerimize karşı sorumluluğumuzdur.*
2. İnsana ve insanın gelişmesine önem vermek.
3. Her işi ilk defada doğru olarak yapmak.
4. Standartlara uygun üretim yapmak.
5. Satış politikamızı "müşteri memnuniyeti" üzerine kurmak.
6. Kaliteli iletişimin olmazsa olmazlığını benimsemek.
7. Sürekli gelişmek.
8. Yapılan her çalışmanın "Türkiye'nin gelişmesi" demek olduğunun ve "dünyaya katma değer sağladığının" bilincinde olmak.
9. Risklerimizin farkında olmak ve risklerimize çözüm üretmek.

MÜŞTERİ MEMNUNİYETİ POLİTİKAMIZ

- 1- Müşterilerimizin mutlaka memnun olmasını sağlamak.
- 2- Tüm çalışmalarımızın çözüm odaklı olmasını sağlamak.
- 3- Tüm şikayet, talep ve beğenileri kayıt altına alarak takibini sağlamak.
- 4- Objektif ve müşteri odaklı olmak.
- 5- Yasal şartlara dayalı hizmet sunmak.
- 6- Şikayetlere dönüştürme ve şikayet çözümünde en hızlı firma olmak.
- 7- Ürün ve hizmet kalitesinin sürekli iyileştirilmesini sağlamak.

ENERJİ YÖNETİMİ POLİTİKAMIZ

- 1- Enerji ve doğal kaynakları verimli kullanmak.
- 2- Ürün ve hizmetleri planlarken ve temin ederken enerji verimliliğini göz önünde bulundurmak.
- 3- Yasal şartlara uygun çalışmak.
- 4- Enerji verimliliği ve tasarruf bilincimizi sürekli geliştirmek.
- 5- Enerji verimliliğimizi sürekli iyileştirerek şirketimizin başarısını artırmak.
- 6- Enerji verimliliğinin sürdürülebilirliğe (çevrenin korunmasına) katkı sağladığının bilincinde olmak.

İŞ GÜVENLİĞİ VE İŞÇİ SAĞLIĞI POLİTİKAMIZ

1. Tüm faaliyetleri sürekli iyileştirmek.
2. Organizasyonun her kademesinin katılımını sağlamak.
3. Önleyici ve düzeltici yaklaşımlarda bulunmak.
4. Tüm çalışanları bilinçlendirmek.
5. Bireyin kendi kendini korumasını sağlamak.
6. İş güvenliği kültürü oluşturmak ve bu kültürü yaşam tarzı haline getirmek.
7. Güvenli bir çalışma ortamı için tehlikeleri ortadan kaldırmak.
8. Yasal mevzuatın öngördüğü standartlara uymak

Adopting quality service and quality product principles and these principles Beka Industrial Kitchen, which realizes without compromise; Beka Industrial Kitchen, has adopted the quality policy focused on guest satisfaction.

QUALITY POLICY

1. Here's how we define quality:
**Quality is a way of life.*
**It is a duty for all of us.*
**It is our responsibility to our customers.*
2. To care for humans and human progress.
3. To do every job properly on the first try.
4. Producing in accordance with standards.
5. To build our sales policy on "Customer Satisfaction"
6. To internalize the fact that quality communication is a must.
7. To constantly improve.
8. To be aware that every work we conduct means "development of Turkey" and "added value for the whole world".
9. To be aware of the risks and find solutions for them.

GUEST SATISFACTION POLICY

- 1- To make sure our customers are satisfied.
- 2- To ensure that all our employees are solution-oriented.
- 3- To keep records of all complaints, requests and credits and keep survey over them.
- 4- To be objective and customer-oriented.
- 5- To serve by legal obligations.
- 6- To be the fastest company in responding to complaints and problem solving.
- 7- To ensure constant enhancement of products and services.

ENERGY MANAGEMENT POLICY

- 1- To utilize energy and natural resources efficiently.
- 2- To take into consideration energy efficiency during the planning and providing of the products and the services.
- 3- To work by legal obligations.
- 4- To constantly enhance our awareness of energy efficiency and savings.
- 5- To increase the success of our company through enhancement of our energy efficiency.
- 6- To be aware that we are contributing to the sustainability of energy efficiency (preservation of nature).

OUR OCCUPATIONAL HEALTH AND SAFETY POLICY

1. To constantly improve all our processes.
2. To ensure the contribution of all levels of the organization.
3. To take preventive and regulatory steps.
4. To increase awareness of all employees.
5. To ensure all individuals are capable of protecting themselves.
6. To create a culture of occupational safety and to turn this culture into a life style.
7. To remove all the risks for a safe working environment.
8. To abide by the standards projected by legal legislations.



"GÜVENİNİZ KALİTEMİZDİR"
"YOUR TRUST IS OUR QUALITY"

İÇİNDEKİLER
INDEX

1 PROSET / PROSET

3

Fritöz
Makarna Haşlama ve Patates Dinlendirme
Gazlı Ocaklar
Elektrikli Ocaklar
Wok Ocaklar
Kuzine
Sos Benmariler
Gazlı Izgaralar
Elektrikli Izgaralar
Gazlı Lavtaşlı Izgaralar
Nötr Ara Tezgahlar ve Alt Dolaplar

2 EKOSSET / ECOSET

15

Künefe Ocakları
Börek Ocakları
İskender Ocakları
Salamander Izgaralar
Tantuni Ocakları
Döner Ocakları
Bazlama Ocakları
Islak Hamburger Üniteleri
Benmariler
Kumda Kahve Ocakları
Fritözler
Ocak ve Kuzineler
Yer Ocakları
Pasta Börek Fırınları ve Bıçak Sterilizasyon

3 NÖTRSET / NOTRSET

51

Çalışma Tezgahları
Evyeli Çalışma Tezgahları ve Yıkama Tezgahları
İstif Rafları
Duvar Dolapları ve Rafları
Taşıma Arabaları
Davlumbazlar

PROSET İNDEKS

1-Fritöz	4
2-Makarna Haşlama ve Patates Dinlendirme	5
3-Gazlı Ocaklar	6
4-Elektrikli Ocaklar	7
5-Wok Ocaklar	8
6-Kuzine	9
7-Sos Benmariler	10
8-Gazlı Izgaralar	11
9-Elektrikli Izgaralar	12
10-Gazlı Lavtaşlı Izgaralar	13
11-Nötr Ara Tezgahlar ve Alt Dolaplar	14

PROSET - 70'LİK SERİ ÜRÜNLER / ELEKTRİKLİ FRİTÖZLER
70'S SERIES / ELECTRICAL FRYERS

PROSET
PROSET



PR470101



PR870101

KODU CODE	ÜRÜN ADI PRODUCT NAME	EBAT (cm) DIM	AĞIRLIK WEIGHT	GÜÇ POWER	NET NET m ³	FİYAT PRICE
PR470101	ELEKTRİKLİ FRİTÖZ ELECTRIC FRYER	40x70x30	20 KG 12 LT.	7,5 KW 380V 3-50 Hz	0,08	1100 €
PR870101	ÇİFTLİ ELEKTRİKLİ FRİTÖZ DOUBLE ELECTRIC FRYER	80x70x30	29 KG 12+12 LT.	15 KW 380V 3-50 Hz	0,17	1830 €

AÇIKLAMALAR \ DESCRIPTIONS



TR

ELEKTRİKLİ FRİTÖZ

- Termostatik kontrol.
- Paslanmaz çelik sepetler.
- Hareketli ısıtıcılar kolay temizlik imkanı sağlar.
- Tahliye musluğu ile emniyetli yağ boşaltma.
- Limit termostat.
- Kolay temizlenebilir ve hijyeniktir.
- Paslanmaz çelik gövde.

ENG

ELECTRIC FRYERS

- Thermostatic control.
- Stainless steel baskets.
- Moving heaters provide easy cleaning.
- Safe oil drainage from the bottom via valve.
- Safety thermostat for overheating protection.
- Easy to clean and hygienic.
- Stainless steel body.

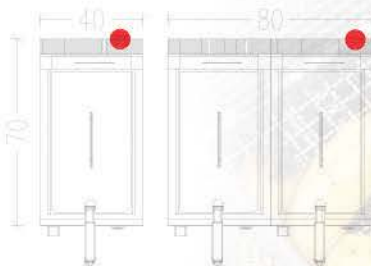

PR470101

PR870101



PR470104



PR470103

KODU CODE	ÜRÜN ADI PRODUCT NAME	EBAT (cm) DIM	AĞIRLIK WEIGHT	GÜÇ POWER	NET NET m ³	FİYAT PRICE
PR470103	PATATES DİNLENDİRME CHIPS SCUTTLE	40x70x30	11 KG	0,75 KW 220V-50 Hz	0,08	590 €
PR470104	MAKARNA HAŞLAMA PASTA COOKER	40x70x30	16 KG 8 LT.	6 KW 380V 3-50 Hz	0,08	1100 €

AÇIKLAMALAR \ DESCRIPTIONS



TR

ENG

PATATES DİNLENDİRME

- Paslanmaz çelik delikli yağ süzgeci sacı
- Infrared seramik ısıtıcı.
- Kolay temizlenebilir ve hijyeniktir.
- Paslanmaz çelik gövde.

CHIPS SCUTTLE

- Stainless steel plate for oil filter
- Infrared ceramic heater
- Easy to clean and hygienic.
- Stainless steel body.

ELEKTRİKLİ MAKARNA HAŞLAMA

- Termostatik kontrol.
- Paslanmaz çelik sepetler.
- Su doldurma musluğu.
- Tahliye musluğu ile su boşaltma.
- Taşan su tahliye sistemi.
- Kolay temizlenebilir ve hijyeniktir.
- Paslanmaz çelik gövde.

ELECTRIC PASTA COOKER

- Thermostatic control.
- Stainless steel baskets.
- Water filling tap.
- Discharge valve.
- Overflow drainage system.
- Easy to clean and hygienic.
- Stainless steel body.

PROSET - 70'LİK SERİ ÜRÜNLER / GAZLI OCAKLAR
70'S SERIES / GAS COOKER

PROSET
PROSET



■ PR470110



■ PR870110

GAZMER CE BELGESİ KODU	KODU	ÜRÜN ADI	EBAT (cm)	AĞIRLIK	GÜÇ	NET	FİYAT
	CODE	PRODUCT NAME	DIM	WEIGHT	POWER	NET m ³	PRICE
BGO-02	PR470110	2'Lİ GAZLI OCAK 2 BURNER GAS COOKER	40x70x30	22 KG	5 KW 20 mbar/NG	0,08	810 €
BGO-04	PR870110	4'LÜ GAZLI OCAK 4 BURNER GAS COOKER	80x70x30	42 KG	10 KW 20 mbar/NG	0,17	1.250 €
BGO-06	PR170110	6'Lİ GAZLI OCAK 6 BURNER GAS COOKER	120x70x30	56 KG	15 KW 20 mbar/NG	0,25	1.940 €

AÇIKLAMALAR \ DESCRIPTIONS



TR

GAZLI OCAK

- Lpg ve Ng ile çalışabilme özelliği.
- Magnet emniyet ventilli musluklar.
- Darbelere karşı dayanıklı üst döküm.
- Her brulör için piezzo çakmak ile kontrol.
- Kolay temizlenebilir ve hijyeniktir.
- Paslanmaz çelik gövde.

ENG

GAS COOKER

- Lpg or Natural Gas.
- Magnet safety gas valve and thermocouple.
- Heavy duty top cast iron.
- Piezoelectric ignition system for each burner.
- Easy to clean and hygienic.
- Stainless steel body.



■ PR170110

■ PR470110

■ PR870110

■ PR170110



PR470111



PR870111

KODU CODE	ÜRÜN ADI PRODUCT NAME	EBAT (cm) DIM	AĞIRLIK WEIGHT	GÜÇ POWER	NET NET m ³	FİYAT PRICE
PR470111	2'Lİ ELEKTRİKLİ OCAK ELECTRICAL COOKER	40x70x30	13 KG	4 KW 380V 3-50 Hz	0,08	625 €
PR870111	4'LÜ ELEKTRİKLİ OCAK ELECTRICAL COOKER	80x70x30	23 KG	8 KW 380V 3-50 Hz	0,17	1.000 €

AÇIKLAMALAR \ DESCRIPTIONS



TR

ELEKTRİKLİ OCAK

- 6 kademeli şalter.
- Kolay temizlenebilir ve hijyeniktir.
- Paslanmaz çelik gövde.

ENG

ELECTRICAL COOKER

- 6 position switches
- Easy to clean and hygienic.
- Stainless steel body.

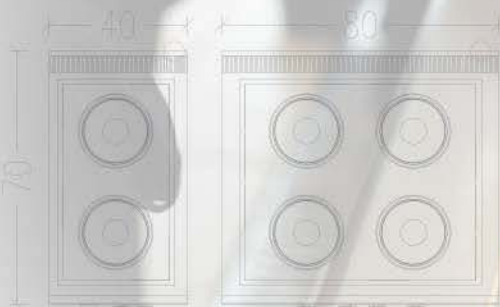

PROSET - 70'LİK SERİ ÜRÜNLER / WOK OCAKLAR
70'S SERIES / WOK COOKER

PROSET
PROSET



PR470112



PR870112

GAZMER CE BELGESİ KODU	KODU CODE	ÜRÜN ADI PRODUCT NAME	EBAT (cm) DIM	AĞIRLIK WEIGHT	GÜÇ POWER	NET NET m ³	FİYAT PRICE
BVK-01	PR470112	TEKLİ GAZLI WOK OCAK 1 BURNER GAS WOK COOKER	40x70x30	31	15 KW 20 mbar/NG	0,08	950 €
BVK-02	PR870112	ÇİFTLİ GAZLI WOK OCAK 2 BURNER GAS WOK COOKER	80x70x30	55	30 KW 20 mbar/NG	0,17	1.500 €

AÇIKLAMALAR \ DESCRIPTIONS



TR

WOK OCAK

- Lpg ve Ng ile çalışabilme özelliği.
- Magnet emniyet ventilli musluklar.
- Darbelere karşı dayanıklı üst döküm.
- Kolay temizlenebilir ve hijyeniktir.
- Paslanmaz çelik gövde.

ENG

WOK COOKER

- Lpg or Natural Gas.
- Magnet safety gas valve and thermocouple.
- Heavy duty top cast iron.
- Easy to clean and hygienic.
- Stainless steel body.



PR870130

GAZNER
CE BELGESİ
KODU

BK-04

KODU CODE	ÜRÜN ADI PRODUCT NAME	EBAT (cm) DIM	AĞIRLIK WEIGHT	GÜÇ POWER	NET NET m ³	FİYAT PRICE
PR870130	GAZLI KUZİNE GAS RANGES WITH OVEN	80x70x85	110 KG	33,5 KW 20 mbar/NG	0,5	2.125 €

AÇIKLAMALAR \ DESCRIPTIONS



TR

GAZLI KUZİNE

- Lpg ve Ng ile çalışabilme özelliği.
- 2xGN 2/1 tepsi kapasiteli paslanmaz çelik fırın haznesi.
- Magnet emniyet ventilli musluklar.
- Darbelere karşı dayanıklı üst döküm.
- Kolay temizlenebilir ve hijyeniktir.
- Paslanmaz çelik gövde.

ENG

GAS RANGES

- Lpg or Natural Gas.
- 2xGN 2/1 capacity, stainless steel internal chamber.
- Magnet safety valves.
- Heavy duty top cast iron.
- Easy to clean and hygienic.
- Stainless steel body.



PR470120



PR870120

KODU CODE	ÜRÜN ADI PRODUCT NAME	EBAT (cm) DIM	AĞIRLIK WEIGHT	GÜÇ POWER	NET NET m ³	FİYAT PRICE
PR470120	SOS BENMARİ BAIN MARIE	40x70x30	13 KG	2,5 KW 220V-50 Hz	0,08	750 €
PR870120	SOS BENMARİ BAIN MARIE	80x70x30	26 KG	5 KW 220V-50 Hz	0,17	1.000 €

AÇIKLAMALAR \ DESCRIPTIONS



TR

SOS BENMARİ

- Termostatik kumanda.
- Yarım modül de 1 adet GN1/1.
- Tam modül de ise 2 adet GN1/1.
- Tahliye musluğu.
- Kolay temizlenebilir ve hijyeniktir.
- Paslanmaz çelik gövde.

ENG

BAIN MARIE

- Thermostatic control.
- Capacity of half modul ; 1 piece of GN1/1.
- Capacity of full modul ; 2 pieces of GN1/1.
- Drainage valve.
- Easy to clean and hygienic.
- Stainless steel body.

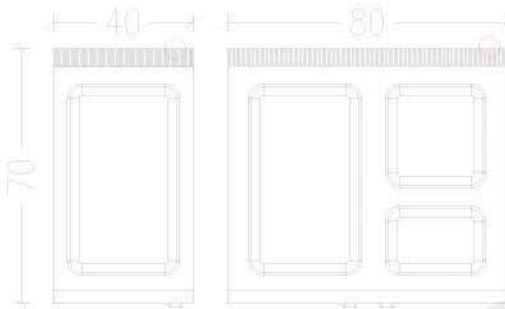



PR470140



PR870140

GAZMER
CE BELGESİ
KODU

BP-01

BP-02

BP-03

KODU CODE	ÜRÜN ADI PRODUCT NAME	EBAT (cm) DIM	AĞIRLIK WEIGHT	GÜÇ POWER	NET NET m ³	FİYAT PRICE
PR470140	GAZLI PLEYT IZGARA GAS GRILL	40x70x30	35 KG	5,4 KW 20 mbar/NG	0,08	1.000 €
PR870140	GAZLI PLEYT IZGARA GAS GRILL	80x70x30	70 KG	10,8 KW 20 mbar/NG	0,17	1.500 €
PR170140	GAZLI PLEYT IZGARA GAS GRILL	120x70x30	103 KG	16,2 KW 20 mbar/NG	0,25	2.000 €

AÇIKLAMALAR \ DESCRIPTIONS



TR

ENG

GAZLI PLEYT IZGARA

- Lpg ve Ng ile çalışabilme özelliği.
- Magnet emniyet ventilli ve pilotlu musluklar.
- Tam modüllerde iki bölgeyi ısıtma.
- Çıkarılabilir yağ toplama haznesi.
- Kolay temizlenebilir ve hijyeniktir.
- Paslanmaz çelik gövde.

GAS GRILL

- Lpg or Natural Gas.
- Magnet safety gas valve and pilot flame.
- Two seperate heating zones.
- Removable oil collection drawer.
- Easy to clean and hygienic.
- Stainless steel body.



DÜZ PLEYT
SMOOTH PLATE

YARI OLUKLU
YARI DÜZ PLEYT
HALF RIBBED
HALF SMOOTH

OLUKLU PLEYT
RIBBED PLATE



PR170140



SİPARİŞ VERİRKEN PLEYT TERCİHİNİZİ BELİRTİNİZ.
PLEASE SELECT PLATE WHEN ORDERING.



PR470141



PR870141

KODU CODE	ÜRÜN ADI PRODUCT NAME	EBAT (cm) DIM	AĞIRLIK WEIGHT	GÜÇ POWER	NET NET m ³	FİYAT PRICE
PR470141	ELEKTRİKLİ PLEYT IZGARA ELECTRICAL GRILL	40x70x30	34 KG	5 KW 380V 3-50 Hz	0,08	815 €
PR870141	ELEKTRİKLİ PLEYT IZGARA ELECTRICAL GRILL	80x70x30	60 KG	9 KW 380V 3-50 Hz	0,17	1.375 €
PR170141	ELEKTRİKLİ PLEYT IZGARA ELECTRICAL GRILL	120x70x30	82 KG	13 KW 380V 3-50 Hz	0,25	1.750 €

AÇIKLAMALAR \ DESCRIPTIONS



TR

ELEKTRİKLİ PLEYT IZGARA

- Termostatik kumanda.
- Tam modüllerde iki bölge ısıtma.
- Çıkarılabilir yağ toplama haznesi
- Kolay temizlenebilir ve hijyeniktir.
- Paslanmaz çelik gövde.

ENG

ELECTRICAL GRILL

- Thermostatic control.
- Two separate heating zones.
- Removable oil collection drawer.
- Easy to clean and hygienic.
- Stainless steel body.



PR170141



DÜZ PLEYT
SMOOTH PLATE



YARI OLUKLU
YARI DÜZ PLEYT
HALF RIBBED
HALF SMOOTH



OLUKLU PLEYT
RIBBED PLATE



SİPARİŞ VERİRKEN PLEYT TERCİHİNİZİ BELİRTİNİZ.
PLEASE SELECT PLATE WHEN ORDERING.



PR470142



PR870142

GAZMER CE BELGESİ KODU	KODU CODE	ÜRÜN ADI PRODUCT NAME	EBAT (cm) DIM	AĞIRLIK WEIGHT	GÜÇ POWER	NET NET m ³	FİYAT PRICE
BLAV-01	PR470142	GAZLI LAVATAŞLI IZGARA GAS LAVSTONE GRILL	40x70x30	26 KG	8 KW 20 mbar/NG	0,08	1.100 €
BLAV-02	PR870142	GAZLI LAVATAŞLI IZGARA GAS LAVSTONE GRILL	80x70x30	49 KG	16 KW 20 mbar/NG	0,17	1.500 €
BLAV-03	PR170142	GAZLI LAVATAŞLI IZGARA GAS LAVSTONE GRILL	120x70x30	78 KG	24 KW 20 mbar/NG	0,25	1.875 €

AÇIKLAMALAR \ DESCRIPTIONS



TR

GAZLI LAVATAŞLI IZGARA

- Lpg ve Ng ile çalışabilme özelliği.
- Magnet emniyet ventilli ve pilotlu musluklar.
- Tam modüllerde iki bölgeyi ısıtma.
- Çıkarılabilir yağ toplama haznesi.
- Kolay temizlenebilir ve hijyeniktir.
- Paslanmazçelik gövde.

ENG

GAS LAVSTONE GRILL

- Lpg or Natural Gas.
- Safety gas valve and pilot flame.
- Two seperate heating zones.
- Removable oil collection drawer.
- Easy to clean and hygienic.
- Stainless steel body.



PR170142

PROSET - 70'LİK SERİ ÜRÜNLER / NÖTR ARA TEZGAHLAR VE ALT DOLAPLAR
70'S SERIES / NEUTRAL COUNTERTOP UNITS AND UNDERCOUNTER CABINET

PROSET
PROSET



PR470150



PR470160



PR870150



PR870160

KODU CODE	ÜRÜN ADI PRODUCT NAME	EBAT (cm) DIM	AĞIRLIK WEIGHT	GÜÇ POWER	NET NET m ³	FİYAT PRICE
PR470150	ARA NÖTR TEZGAH WORK TOP - NEUTRAL	40x70x30	8 KG	NÖTR NEUTRAL	0,08	375 €
PR870150	ARA NÖTR TEZGAH WORK TOP - NEUTRAL	80x70x30	15 KG	NÖTR NEUTRAL	0,17	500 €
PR470160	SET ALTI NÖTR DOLAP UNDERCOUNTER CABINET	40x70x55	15 KG	NÖTR NEUTRAL	0,15	400 €
PR870160	SET ALTI NÖTR DOLAP UNDERCOUNTER CABINET	80x70x55	20 KG	NÖTR NEUTRAL	0,3	525 €
PR170160	SET ALTI NÖTR DOLAP UNDERCOUNTER CABINET	120x70x55	25 KG	NÖTR NEUTRAL	0,45	650 €

AÇIKLAMALAR \ DESCRIPTIONS

TR

ARA NÖTR TEZGAH

- Tezgah üst yüzeyleri ara ya da ön hazırlıklar için idealdir.
- Kolay temizlenebilir ve hijyeniktir.
- Paslanmaz çelik gövde.

ENG

WORK TOP

- Provides preliminary preparation by upper surfaces.
- Easy to clean and hygienic.
- Stainless steel body.

SET ALTI NÖTR DOLAP

- Pişirici ünitelerin altı için tasarlanmış kapaklı nötr dolap
- Kolay temizlenebilir ve hijyeniktir.
- Paslanmaz çelik gövde.

UNDERCOUNTER CABINET

- Design for neutral countertop units
- Easy to clean and hygienic.
- Stainless steel body.



PR170160

EKOSET İNDEKS

1-Künefe Ocakları _____	16
2-Börek Ocakları _____	22
3-İskender Ocakları _____	29
4-Salamander Izgaralar _____	30
5- Tantuni Ocakları _____	31
6-Döner Ocakları _____	32
7-Bazlama Ocakları _____	34
8-İslak Hamburger Üniteleri _____	35
9-Benmariler _____	36
10-Kumda Kahve Ocakları _____	38
11-Fritözler _____	39
12-Ocak ve Kuzineler _____	40
13-Yer Ocakları _____	47
14-Pasta Börek Fırınları ve Bıçak Sterilizasyon _____	49

EKOSET / TEK YANIŞLI KÜNEFE OCAKLARI

ECOSET / SINGLE BURNER KUNEFEE COOKERS

EKOSET
ECOSET



■ EK720101



■ EK720102



■ EK920103



■ EK550104



■ EK850105



■ EK150106



■ EK150107

TEK YANIŞLI KÜNEFE OCAKLARI / ONE BURNER KUNEFEE COOKERS

GAZMER CE BELGESİ KODU	KODU CODE	ÜRÜN ADI PRODUCT NAME	EBAT (cm) DIM	AĞIRLIK WEIGHT	GÜÇ POWER	NET NET m ³	FİYAT PRICE
BKO-03	EK720101	3'LÜ TEK YANIŞLI KÜNEFE OCAĞI 3x1 BURNER KUNEFEE COOKER	70x25x20	7 KG	1,8 KW 20 mbar/NG	0,04	300 €
BKO-04	EK920102	4'LÜ TEK YANIŞLI KÜNEFE OCAĞI 4X1 BURNER KUNEFEE COOKER	90x25x20	10 KG	2,4 KW 20 mbar/NG	0,04	400 €
BKO-04	EK550103	4'LÜ TEK YANIŞLI KÜNEFE OCAĞI 4X1 BURNER KUNEFEE COOKER	50x50x20	12 KG	2,4 KW 20 mbar/NG	0,06	400 €
BKO-06	EK850104	6'LI TEK YANIŞLI KÜNEFE OCAĞI 6x1 BURNER KUNEFEE COOKER	80x50x20	20 KG	3,6 KW 20 mbar/NG	0,09	600 €
BKO-08	EK150105	8'LI TEK YANIŞLI KÜNEFE OCAĞI 8x1 BURNER KUNEFEE COOKER	100x50x20	25 KG	4,8 KW 20 mbar/NG	0,12	800 €
BKO-10	EK150106	10'LU TEK YANIŞLI KÜNEFE OCAĞI 10x1 BURNER KUNEFEE COOKER	120x50x20	30 KG	6,0 KW 20 mbar/NG	0,14	1.000 €
BKO-12	EK150107	12'Lİ TEK YANIŞLI KÜNEFE OCAĞI 12x1 BURNER KUNEFEE COOKER	150x50x20	35 KG	7,2 KW 20 mbar/NG	0,17	1.200 €

AÇIKLAMALAR \ DESCRIPTIONS



TR

KÜNEFE OCAĞI

- Künefe tabağı sabitleyici çember.
- Brülör yarışlarının kolay kontrolü için ayrı renkte gaz düğmeleri
- Emniyet ventili valf.
- Alev denetleme tertibatı.
- LPG veya doğal gaza uyumlu.
- Kolay temizlenebilir ve hijyeniktir.
- Paslanmaz çelik gövde.

ENG

KUNEFEE COOKER

- Künefe plate fixing ring.
- Easy control for burner fire by seperate color buttons
- Safety valve.
- Flame monitoring device.
- Compatible with LPG or natural gas.
- Easy to clean and hygienic.
- Stainless steel body.

EKOSET / TEK YANIŞLI BASAMAKLI KÜNEFE OCAKLARI
ECOSSET / SINGLE BURNER STEPPED KÜNEFE COOKERS

EKOSET
ECOSSET



■ EK850131



■ EK150133



■ EK150132



■ EK150134

TEK YANIŞLI BASAMAKLI KÜNEFE OCAKLARI / ONE BURNER STEPPED KUNEFEE COOKERS

GAZMER
CE BELGESİ
KODU

BKO-06

BKO-08

BKO-10

BKO-12

KODU CODE	ÜRÜN ADI PRODUCT NAME	EBAT (cm) DIM	AĞIRLIK WEIGHT	GÜÇ POWER	NET NET m ³	FİYAT PRICE
EK850131	6'Lİ BASAMAKLI KÜNEFE OCAĞI 6x1 STEPPED KUNEFEE COOKER	80x50x25 /30	21 KG	3,6 KW 20 mbar/NG	0,12	600 €
EK150132	8'Lİ BASAMAKLI KÜNEFE OCAĞI 8x1 STEPPED KUNEFEE COOKER	100x50x25 /30	26 KG	4,8 KW 20 mbar/NG	0,15	800 €
EK150133	10x1'Lİ BASAMAKLI KÜNEFE OCAĞI 10x1 STEPPED KUNEFEE COOKER	120x50x25 /30	31 KG	6,0 KW 20 mbar/NG	0,18	1.000 €
EK150134	12x1'Lİ BASAMAKLI KÜNEFE OCAĞI 12x1 STEPPED KUNEFEE COOKER	150x50x25 /30	36 KG	7,2 KW 20 mbar/NG	0,23	1.200 €

AÇIKLAMALAR \ DESCRIPTIONS



TR

ENG

KÜNEFE OCAĞI

- Künefe tabağı sabitleyici çember.
- Brülör yarıklarının kolay kontrolü için ayrı renkte gaz düğmeleri
- Rahat pişirme konforu için yükseltilmiş üst tabla
- Emniyet ventili valf.
- Alev denetleme tertibatı.
- LPG veya doğal gaza uyumlu.
- Kolay temizlenebilir ve hijyeniktir.
- Paslanmaz çelik gövde.

KUNEFEE COOKER

- Künefe plate fixing ring.
- Easy control for burner fire by separate color buttons
- High step for comfortable cooking
- Safety valve.
- Flame monitoring device.
- Compatible with LPG or natural gas.
- Easy to clean and hygienic.
- Stainless steel body.



! MOTOR / APARAT 160 €

ENGINE PART

Tek brülör için tek motor gerekmektedir.
Örnek ; EK850131 Kodlu ürünü motorlu istediğiniz takdirde;
6x160 € = 960 € + 330 € = 1.290 €
Şeklinde hesaplanmalıdır.

One engine is required for one burner.



EKOSET / 3 YANIŞLI KÜNEFE OCAKLARI

ECOSSET / THREE BURNER KUNEFEE COOKERS



■ EK440141



■ EK140142



■ EK140143



■ EK140144

ÜÇ YANIŞLI KÜNEFE OCAKLARI / THREE BURNER KUNEFEE COOKERS

GAZMER CE BELGESİ KODU	KODU CODE	ÜRÜN ADI PRODUCT NAME	EBAT (cm) DIM	AĞIRLIK WEIGHT	GÜÇ POWER	NET NET m ³	FİYAT PRICE
BKO-03	EK440141	1x3'LÜ KÜNEFE OCAĞI KUNEFEE COOKER	40x40x25	6 KG	1,8 KW 20 mbar/NG	0,04	350 €
BKO-06	EK140142	2x3'LÜ KÜNEFE OCAĞI KUNEFEE COOKER	80x40x25	12 KG	3,6 KW 20 mbar/NG	0,08	700 €
BKO-09	EK140143	3x3'LÜ KÜNEFE OCAĞI KUNEFEE COOKER	120x40x25	18 KG	5,4 KW 20 mbar/NG	0,12	1.050 €
BKO-12	EK140144	4x3'LÜ KÜNEFE OCAĞI KUNEFEE COOKER	160x40x25	24 KG	7,2 KW 20 mbar/NG	0,16	1.400 €
BKO-15	EK240145	5x3'Lİ KÜNEFE OCAĞI KUNEFEE COOKER	200x40x25	30 KG	9 KW 20 mbar/NG	0,20	1.750 €

AÇIKLAMALAR \ DESCRIPTIONS



TR

ENG

KÜNEFE OCAĞI

- Künefe tabağı sabitleyici çember.
- Brülör yarıklarının kolay kontrolü için ayrı renkte gaz düğmeleri
- Rahat pişirme konforu için yükseltilmiş üst tabla
- Emniyet ventili valf.
- Alev denetleme tertibatı.
- LPG veya doğal gaza uyumlu.
- Kolay temizlenebilir ve hijyeniktir.
- Paslanmaz çelik gövde.

KUNEFEE COOKER

- Künefe plate fixing ring.
- Easy control for burner fire by separate color buttons
- High step for comfortable cooking
- Safety valve.
- Flame monitoring device.
- Compatible with LPG or natural gas.
- Easy to clean and hygienic.
- Stainless steel body.



MOTOR / APARAT 160 €
ENGINE PART
Tek brülör için tek motor gerekmektedir.
One engine is required for one burner.



■ EK440144



■ EK880151



■ EK180153



■ EK180152



■ EK280154

ÜÇ YANIŞLI KÜNEFE OCAKLARI / THREE BURNER KUNEFEE COOKERS

GAZMER CE BELGESİ KODU	KODU CODE	ÜRÜN ADI PRODUCT NAME	EBAT (cm) DIM	AĞIRLIK WEIGHT	GÜÇ POWER	NET NET m ³	FİYAT PRICE
BKO-12	EK880151	4'LÜ ÜÇ YANIŞLI KÜNEFE OCAĞI 4x3 BURNER KUNEFEE COOKER	80x75x25 /30	25 KG	7,2 KW 20 mbar/NG	0,18	1.400 €
BKO-18	EK180152	6'LI ÜÇ YANIŞLI KÜNEFE OCAĞI 6x3 BURNER KUNEFEE COOKER	120x75x25 /30	37 KG	10,8 KW 20 mbar/NG	0,27	2.100 €
BKO-24	EK180153	8'Lİ ÜÇ YANIŞLI KÜNEFE OCAĞI 8x3 BURNER KUNEFEE COOKER	160x75x25 /30	49 KG	14,4 KW 20 mbar/NG	0,36	2.800 €
BKO-30	EK280154	10'LU ÜÇ YANIŞLI KÜNEFE OCAĞI 10x3 BURNER KUNEFEE COOKER	200x75x25 /30	61 KG	18 KW 20 mbar/NG	0,45	3.500 €
BKO-36	EK280155	12'Lİ ÜÇ YANIŞLI KÜNEFE OCAĞI 12x3 BURNER KUNEFEE COOKER	235x75x25 /30	72 KG	21,6 KW 20 mbar/NG	0,53	4.200 €

AÇIKLAMALAR \ DESCRIPTIONS



TR

KÜNEFE OCAĞI

- Künefe tabağı sabitleyici çember.
- Brülör yarıklarının kolay kontrolü için ayrı renkte gaz düğmeleri
- Rahat pişirme konforu için yükseltilmiş üst tabla
- Emniyet ventili valf.
- Alev denetleme tertibatı.
- LPG veya doğal gaza uyumlu.
- Kolay temizlenebilir ve hijyeniktir.
- Paslanmaz çelik gövde.

ENG

KUNEFEE COOKER

- Künefe plate fixing ring.
- Easy control for burner fire by separate color buttons
- High step for comfortable cooking
- Safety valve.
- Flame monitoring device.
- Compatible with LPG or natural gas.
- Easy to clean and hygienic.
- Stainless steel body.



■ EK280155

MOTOR / APARAT 160 €
ENGINE PART

Tek brülör için tek motor gerekmektedir.
One engine is required for one burner.



EKOSET / KOMBİNASYON YANIŞLI BASAMAKLI KÜNEFE OCAKLARI

ECOSET / COMBINATION BURNER STEPPED KUNEFEE COOKERS

EKOSET
ECOSET



■ EK880176



■ EK180178



■ EK180177



■ EK280179

KOMBİNASYON YANIŞLI KÜNEFE OCAKLARI / COMBINATION BURNER KUNEFEE COOKERS

GAZMER CE BELGESİ KODU	KODU CODE	ÜRÜN ADI PRODUCT NAME	EBAT (cm) DIM	AĞIRLIK WEIGHT	GÜÇ POWER	NET NET m ³	FİYAT PRICE
BKO-13	EK880176	(2x3)+(7x1) BASAMAKLI KÜNEFE OCAĞI STEPPED KUNEFEE COOKER	80x80x25 /30	26 KG	7,8 KW 20 mbar/NG	0,19	1.400 €
BKO-20	EK180177	(3x3)+(11x1) BASAMAKLI KÜNEFE OCAĞI STEPPED KUNEFEE COOKER	120x80x25 /30	38 KG	12 KW 20 mbar/NG	0,28	2.150 €
BKO-28	EK180178	(4x3)+(16x1) BASAMAKLI KÜNEFE OCAĞI STEPPED KUNEFEE COOKER	160x80x25 /30	52 KG	16,8 KW 20 mbar/NG	0,38	3.000 €
BKO-36	EK280179	(5x3)+(20x1) BASAMAKLI KÜNEFE OCAĞI STEPPED KUNEFEE COOKER	200x80x25 /30	66 KG	21,6 KW 20 mbar/NG	0,48	3.750 €
BKO-40	EK280180	(6x3)+(22x1) BASAMAKLI KÜNEFE OCAĞI STEPPED KUNEFEE COOKER	235x80x25 /30	77 KG	24 KW 20 mbar/NG	0,56	4.300 €

AÇIKLAMALAR \ DESCRIPTIONS



TR

KÜNEFE OCAĞI

- Künefe tabağı sabitleyici çember.
- Brülör yarıklarının kolay kontrolü için ayrı renkte gaz düğmeleri
- Rahat pişirme konforu için yükseltilmiş üst tabla
- Emniyet ventili valf.
- Alev denetleme tertibatı.
- LPG veya doğal gaza uyumlu.
- Kolay temizlenebilir ve hijyeniktir.
- Paslanmaz çelik gövde.

ENG

KUNEFEE COOKER

- Künefe plate fixing ring.
- Easy control for burner fire by separate color buttons
- High step for comfortable cooking
- Safety valve.
- Flame monitoring device.
- Compatible with LPG or natural gas.
- Easy to clean and hygienic.
- Stainless steel body.

! MOTOR / APARAT 160 €

ENGINE PART

Tek brülör için tek motor gerekmektedir.
One engine is required for one burner.



■ EK280180

EKOSET / KOMBİNASYON YANIŞLI BASAMAKLI KÜNEFE OCAKLARI

ECOSSET / COMBINATION BURNER STEPPED KÜNEFE COOKERS

EKOSET
ECOSSET



■ EK860171



■ EK160173



■ EK160172



■ EK260174

KOMBİNASYON YANIŞLI KÜNEFE OCAKLARI / COMBINATION BURNER KÜNEFE COOKERS

GAZMER CE BELGESİ KODU	KODU CODE	ÜRÜN ADI PRODUCT NAME	EBAT (cm) DIM	AĞIRLIK WEIGHT	GÜÇ POWER	NET NET m ³	FİYAT PRICE
BKO-10	EK860171	(2x3)+(4x1) BASAMAKLI KÜNEFE OCAĞI STEPPED KÜNEFE COOKER	80x65x25 /30	14 KG	6 KW 20 mbar/NG	0,15	1.100 €
BKO-15	EK160172	(3x3)+(6x1) BASAMAKLI KÜNEFE OCAĞI STEPPED KÜNEFE COOKER	120x65x25 /30	21 KG	9 KW 20 mbar/NG	0,23	1.650 €
BKO-20	EK160173	(4x3)+(8x1) BASAMAKLI KÜNEFE OCAĞI STEPPED KÜNEFE COOKER	160x65x25 /30	28 KG	12 KW 20 mbar/NG	0,31	2.200 €
BKO-25	EK260174	(5x3)+(10x1) BASAMAKLI KÜNEFE OCAĞI STEPPED KÜNEFE COOKER	200x65x25 /30	36 KG	15 KW 20 mbar/NG	0,39	2.750 €
BKO-30	EK260175	(6x3)+(12x1) BASAMAKLI KÜNEFE OCAĞI STEPPED KÜNEFE COOKER	235x65x25 /30	42 KG	18 KW 20 mbar/NG	0,46	3.300 €

AÇIKLAMALAR \ DESCRIPTIONS



TR	KÜNEFE OCAĞI	KÜNEFE COOKER
ENG	<ul style="list-style-type: none"> - Künefe tabağı sabitleyici çember. - Brülör yarıklarının kolay kontrolü için ayrı renkte gaz düğmeleri - Rahat pişirme konforu için yükseltilmiş üst tabla - Emniyet ventili valf. - Alev denetleme tertibatı. - LPG veya doğal gaza uyumlu. - Kolay temizlenebilir ve hijyeniktir. - Paslanmaz çelik gövde. 	<ul style="list-style-type: none"> - Künefe plate fixing ring. - Easy control for burner fire by seperate color buttons - High step for comfortable cooking - Safety valve. - Flame monitoring device. - Compatible with LPG or natural gas. - Easy to clean and hygienic. - Stainless steel body.

! MOTOR / APARAT 160 €

ENGINE PART

Tek brülör için tek motor gerekmektedir.
One engine is required for one burner.



■ EK260175

EKOSET / GAZLI MOTORLU TABAN RAFLI BÖREK OCAKLARI

ECOSET / GAS - PASTRY COOKERS WITH ENGINE AND BOTTOM SHELF

EKOSET
ECOSET



EK770251

! Camlı modellerde %10 fiyat farkı eklenir.
10% price difference is added for glass models.



EK170252



TABAN RAFLI SU BÖREĞİ OCAKLARI / PASTRY COOKERS WITH BOTTOM SHELF

GAZMER CE BELGESİ KODU	KODU CODE	ÜRÜN ADI PRODUCT NAME	EBAT (cm) DIM	AĞIRLIK WEIGHT	GÜÇ POWER	NET NET m ³	FİYAT PRICE
BKO-04	EK770251	TABAN RAFLI SU BÖREĞİ OCAĞI PASTRY COOKER WITH BOTTOM SHELF	70x70x85	30 KG	2,4 KW 20 mbar/NG	0,42	1.000 €
BKO-08	EK170252	TABAN RAFLI SU BÖREĞİ OCAĞI PASTRY COOKER WITH BOTTOM SHELF	140x70x85	45 KG	4,8 KW 20 mbar/NG	0,83	2.000 €
BKO-12	EK270253	TABAN RAFLI SU BÖREĞİ OCAĞI PASTRY COOKER WITH BOTTOM SHELF	210x70x85	60 KG	7,2 KW 20 mbar/NG	1,24	3.000 €
BKO-16	EK270254	TABAN RAFLI SU BÖREĞİ OCAĞI PASTRY COOKER WITH BOTTOM SHELF	280x70x85	75 KG	9,6 KW 20 mbar/NG	1,66	4.000 €

AÇIKLAMALAR \ DESCRIPTIONS



TR

TABAN RAFLI SU BÖREĞİ OCAĞI

- Emniyet ventili valf.
- LPG ve doğal gaz uyumlu.
- Motorlu aparat sayesinde dengeli pişirme.
- Dökülen börek parçalarını temizleyebilmek için kırıntı çekmecesi
- Ayarlanabilir ayaklar.
- Kolay temizlenebilir ve hijyeniktir.
- Paslanmaz çelik gövde.

ENG

PASTRY COOKER WITH BOTTOM SHELF

- Safety valve.
- LPG and natural gas compatible.
- Balanced cooking by engine part
- Crumb drawer for to clean pieces of spilled pastry
- Adjustable feet.
- Easy to clean and hygienic.
- Stainless steel body.



EK270253

! Camlı ve dolaplı modellerde %20 fiyat farkı eklenir.
20% price difference is added for glass and cupboard models.



EK270254



! BU SAYFADA BULUNAN ÜRÜNLER MOTORLUDUR. BU SEBEPLERİ HER BİR ÜRÜN 220V-50Hz ELEKTRİK BAĞLANTISI (PRİZ) GEREKSİNİMİ DUYMAKTADIR.

ALL PRODUCT WITH ENGINE ON THIS PAGE.
THE PRODUCTS IN THIS PAGE NEED AN ELECTRICAL CONNECTION - 220V-50Hz

EKOSET / GAZLI MOTORLU SET ÜSTÜ BÖREK OCAKLARI

ECOSET / GAS - PASTRY COOKERS COUNTER TOP WITH ENGINE

EKOSET
ECOSET



EK770201



EK170202

GAZLI SET ÜSTÜ SU BÖREĞİ OCAKLARI/COUNTER TOP PASTRY COOKERS

GAZMER CE BELGESİ KODU	KODU CODE	ÜRÜN ADI PRODUCT NAME	EBAT (cm) DIM	AĞIRLIK WEIGHT	GÜÇ POWER	NET NET m ³	FİYAT PRICE
BKO-04	EK770201	SET ÜSTÜ SU BÖREĞİ OCAĞI COUNTER TOP PASTRY COOKER	70x70x28	20 KG	2,4 KW 20 mbar/NG	0,14	900 €
BKO-08	EK170202	SET ÜSTÜ SU BÖREĞİ OCAĞI COUNTER TOP PASTRY COOKER	140x70x28	35 KG	4,8 KW 20 mbar/NG	0,28	1.800 €
BKO-12	EK270203	SET ÜSTÜ SU BÖREĞİ OCAĞI COUNTER TOP PASTRY COOKER	210x70x28	45 KG	7,2 KW 20 mbar/NG	0,41	2.700 €
BKO-16	EK270204	SET ÜSTÜ SU BÖREĞİ OCAĞI COUNTER TOP PASTRY COOKER	280x70x28	60 KG	9,6 KW 20 mbar/NG	0,55	3.600 €

AÇIKLAMALAR \ DESCRIPTIONS



TR

ENG

SET ÜSTÜ SU BÖREĞİ OCAĞI

- Emniyet ventili valf.
- LPG ve doğal gaz uyumlu.
- Motorlu aparat sayesinde dengeli pişirme.
- Dökülen börek parçalarını temizleyebilmek için kırıntı çekmecesini.
- Ayarlanabilir ayaklar.
- Kolay temizlenebilir ve hijyeniktir.
- Paslanmaz çelik gövde.

COUNTER TOP PASTRY COOKER

- Safety valve.
- LPG and natural gas compatible.
- Balanced cooking by engine part
- Crumb drawer for to clean pieces of spilled pastry
- Adjustable feet.
- Easy to clean and hygienic.
- Stainless steel body.

BU SAYFADA BULUNAN ÜRÜNLER MOTORLUDUR. BU SEBEPLERİ HER BİR ÜRÜN 220V-50Hz ELEKTRİK BAĞLANTISI (PRİZ) GEREKSİNİMİ DUYMAKTADIR.

Camlı modellerde %10 fiyat farkı eklenir. 10% price difference is added for glass models.

ALL PRODUCT WITH ENGINE ON THIS PAGE. THE PRODUCTS IN THIS PAGE NEED AN ELECTRICAL CONNECTION - 220V-50Hz



Ahtapot aparat; su böreği ocağınızı künefe ocağı olarak kullanmanızı sağlar. Montajı basit, kullanımı kolaydır. Ahtapot aparatında aynı anda 6 adet tek porsiyonluk künefe pişirebilirsiniz.

Octopus part; allows you to use your pastry cooker as a künefe cooker. Installation is simple, easy to use. In the octopus apparatus you can cook 6 single portions of künefe.

AHTAPOT APARAT 100 €

OCTOPUS PART

Su böreği ocakları standart olarak "yıldız aparat" ile gelmektedir. "Ahtapot aparat" istediğiniz takdirde sipariş verirken belirtiniz.

Pastry cookers come as standard with a "star apparatus". Please specify "octopus apparatus" when ordering.

BEKA
ENDÜSTRİYEL MUTFAK

[/beka.mutfak](https://www.bekamutfak.com.tr) [/bekamutfak](https://www.bekamutfak.com.tr) www.bekamutfak.com.tr



EK270203

EK270204

EKOSET / TABAN RAFLI SU BÖREĞİ DİNLENDİRME ÜNİTELERİ

ECOSET / PASTRY BAINMARIES WITH BOTTOM SHELF

EKOSET
ECOSET



■ EK770255



Camlı modellerde %10 fiyat farkı eklenir,
10% price difference is added for glass models.



■ EK170256

ELEKTRİKLİ TABAN RAFLI SU BÖREĞİ DİNLENDİRME ÜNİTELERİ / ELECTRICAL PASTRY BAINMARIE WITH B. SHELF

KODU CODE	ÜRÜN ADI PRODUCT NAME	EBAT (cm) DIM	AĞIRLIK WEIGHT	GÜÇ POWER	NET NET m ³	FİYAT PRICE
■ EK770255	TEKLİ SU BÖREĞİ DİNLENDİRME SINGLE PASTRY BAINMARIE	70x70x85	30 KG	1,5 KW 220V-50 Hz	0,42	700 €
■ EK170256	İKİLİ SU BÖREĞİ DİNLENDİRME DOUBLE PASTRY BAINMARIE	140x70x85	45 KG	2,5 KW 220V-50 Hz	0,83	1.350 €
■ EK270257	ÜÇLÜ SU BÖREĞİ DİNLENDİRME TRIPLE TOP PASTRY BAINMARIE	210x70x85	60 KG	3 KW 220V-50 Hz	1,24	2.000 €
■ EK270258	DÖRTLÜ SU BÖREĞİ DİNLENDİRME QUADRUPLE PASTRY BAINMARIE	280x70x85	75 KG	5 KW 220V-50 Hz	1,66	2.600 €

AÇIKLAMALAR \ DESCRIPTIONS



TR

TABAN RAFLI SU BÖREĞİ DİNLENDİRME

- Elektrikli rezistans sistemi
- Küresel vanalı alttan su tahliye sistemi
- Havuz için delikli sac aparat
- Ayarlanabilir ayaklar.
- Kolay temizlenebilir ve hijyeniktir.
- Paslanmaz çelik gövde.

ENG

PASTRY BAINMARIE WITH BOTTOMSHELF

- Electrical resistance system
- Bottom water relief valve
- Perforated sheet part for pool
- Adjustable feet.
- Easy to clean and hygienic.
- Stainless steel body.



■ EK270257



Camlı ve dolaplı modellerde %20 fiyat farkı eklenir.
20% price difference is added for glass and cupboard models.



■ EK270258



■ EK770205



■ EK170206

ELEKTRİKLİ SET ÜSTÜ SU BÖREĞİ DİNLENDİRME ÜNİTELERİ / ELECTRICAL COUNTER TOP PASTRY BAINMARIE

KODU CODE	ÜRÜN ADI PRODUCT NAME	EBAT (cm) DIM	AĞIRLIK WEIGHT	GÜÇ POWER	NET NET m ³	FİYAT PRICE
■ EK770205	TEKLİ SU BÖREĞİ DİNLENDİRME SINGLE PASTRY BAINMARIE	70x70x28	20 KG	1,5 KW 220V-50 Hz	0,14	600 €
■ EK170206	İKİLİ SU BÖREĞİ DİNLENDİRME DOUBLE PASTRY BAINMARIE	140x70x28	35 KG	2,5 KW 220V-50 Hz	0,28	1.100 €
■ EK270207	ÜÇLÜ SU BÖREĞİ DİNLENDİRME TRIPLE TOP PASTRY BAINMARIE	210x70x28	45 KG	3 KW 220V-50 Hz	0,41	1.600 €
■ EK270208	DÖRTLÜ SU BÖREĞİ DİNLENDİRME QUADRUPLE PASTRY BAINMARIE	280x70x28	60 KG	5 KW 220V-50 Hz	0,55	2.100 €

AÇIKLAMALAR \ DESCRIPTIONS



TR

SET ÜSTÜ SU BÖREĞİ DİNLENDİRME

- Elektrikli rezistans sistemi
- Küresel vanalı ön su tahliye sistemi
- Havuz için delikli sac aparat
- Ayarlanabilir ayaklar.
- Kolay temizlenebilir ve hijyeniktir.
- Paslanmaz çelik gövde.

ENG

COUNTER TOP PASTRY BAINMARIE

- Electrical resistance system
- Front water relief valve
- Perforated sheet part for pool
- Adjustable feet.
- Easy to clean and hygienic.
- Stainless steel body.



■ EK270207



■ EK270208

! Camlı modellerde %10 fiyat farkı eklenir.
10% price difference is added for glass models.

EKOSET / ÇİFTLİ GOLD SU BÖREĞİ OCAKLARI

ECOSSET / DOUBLE GOLD PASTRY COOKER

EKOSET
ECOSSET



■ EK770451



ÇİFTLİ GOLD SU BÖREĞİ OCAĞI / DOUBLE GOLD PASTRY COOKER

GAZMER CE BELGESİ KODU	KODU CODE	ÜRÜN ADI PRODUCT NAME	EBAT (cm) DIM	AĞIRLIK WEIGHT	GÜÇ POWER	NET NET m ³	FIYAT PRICE
BTR-08	■ EK770451	GOLD SU BÖREĞİ OCAĞI-ÖN DEKORLU 1x4 GOLD P.COOK.-FRONT DECORATED	140x70x85 /135	120 KG	4,8 KW 20 mbar/NG	0,84	4.200 €
BTR-08	■ EK770452	GOLD SU B. OCAĞI-ÜÇ CEPHE DEKORLU 1x4 GOLD P.COOK.-THREE DECORATED	140x70x85 /135	140 KG	4,8 KW 20 mbar/NG	0,84	5.000 €

AÇIKLAMALAR \ DESCRIPTIONS



TR

GOLD SU BÖREĞİ OCAĞI

- Emniyet ventili valf.
- LPG ve doğal gaz uyumlu.
- Ayarlanabilir ayaklar.
- Kolay temizlenebilir ve hijyeniktir.
- Paslanmaz çelik gold gövde.
- Üst dekoratif servis camlı
- Opsiyonel ön seramik dekor

ENG

GOLD PASTRY COOKER WITH BOTTOM SHELF

- Safety valve.
- LPG and natural gas compatible.
- Adjustable feet.
- Easy to clean and hygienic.
- Stainless steel gold body.
- Countertop service glass
- Front ceramic decoration

! SİPARİŞ VERİRKEN GRANİT-SERAMİK MODELİNİ BELİRTİNİZ.

PLEASE PICK CERAMIC MODEL WHEN ORDERING.

! BU SAYFADA BULUNAN ÜRÜNLER MOTORLUDUR. BU SEBEPLE HER BİR ÜRÜN 220V-50Hz ELEKTRİK BAĞLANTISI (PRİZ) GEREKSİNİMİ DUYMAKTADIR.

ALL PRODUCT WITH ENGINE ON THIS PAGE.
THE PRODUCTS IN THIS PAGE NEED AN
ELECTRICAL CONNECTION - 220V-50Hz

! SİPARİŞ VERİRKEN GRANİT-SERAMİK MODELİNİ BELİRTİNİZ.

PLEASE PICK CERAMIC MODEL WHEN ORDERING.



■ EK770452



SAVONA

CARRARA

LEPARDO

DOLCE

FORENZA

VITELLO

MARINA

LATTE

VERONA

BU SAYFADA BULUNAN ÜRÜNLER MOTORLUDUR. BU SEBEPLE HER BİR ÜRÜN 220V-50Hz ELEKTRİK BAĞLANTISI (PRİZ) GEREKSİNİMİ DUYMAKTADIR.

ALL PRODUCT WITH ENGINE ON THIS PAGE.
THE PRODUCTS IN THIS PAGE NEED AN ELECTRICAL CONNECTION - 220V-50Hz



Ahtapot aparatı; su böreği ocağınızı künefe ocağı olarak kullanmanızı sağlar. Montajı basit, kullanımı kolaydır. Ahtapot aparatında aynı anda 6 adet tek porsiyonluk künefe pişirebilirsiniz.

Octopus part; allows you to use your pastry cooker as a künefe cooker. Installation is simple, easy to use. In the octopus apparatus you can cook 6 single portions of künefe.

AHTAPOT APARAT

100 €

OCTOPUS PART

Su böreği ocakları standart olarak "yıldız aparat" ile gelmektedir. "Ahtapot aparat" istediğiniz takdirde sipariş verirken belirtiniz.

Pastry cookers come as standard with a "star apparatus". Please specify "octopus apparatus" when ordering.



■ EK770401

GOLD SU BÖREĞİ OCAĞI / GOLD PASTRY COOKER

GAZMER
CE BELGESİ
KODU

BKO-04

BKO-04

KODU CODE	ÜRÜN ADI PRODUCT NAME	EBAT (cm) DIM	AĞIRLIK WEIGHT	GÜÇ POWER	NET NET m ³	FİYAT PRICE
EK770401	GOLD SU BÖREĞİ OCAĞI-ÖN DEKORLU 1x4 GOLD P.COOK.-FRONT DECORATED	70x70x85 /135	60 KG	2,4 KW 20 mbar/NG	0,42	2.200 €
EK770402	GOLD SU B. OCAĞI-ÜÇ CEPHE DEKORLU 1x4 GOLD P.COOK.-THREE DECORATED	70x70x85 /135	70 KG	2,4 KW 20 mbar/NG	0,42	2.500 €

TR

AÇIKLAMALAR \ DESCRIPTIONS



ENG

GOLD SU BÖREĞİ OCAĞI

- Emniyet ventilli valf.
- LPG ve doğal gaz uyumlu.
- Ayarlanabilir ayaklar.
- Kolay temizlenebilir ve hijyeniktir.
- Paslanmaz çelik gold gövde.
- Üst dekoratif servis camlı
- Opsiyonel ön seramik dekor

GOLD PASTRY COOKER WITH BOTTOM SHELF

- Safety valve.
- LPG and natural gas compatible.
- Adjustable feet.
- Easy to clean and hygienic.
- Stainless steel gold body.
- Countertop service glass
- Front ceramic decoration

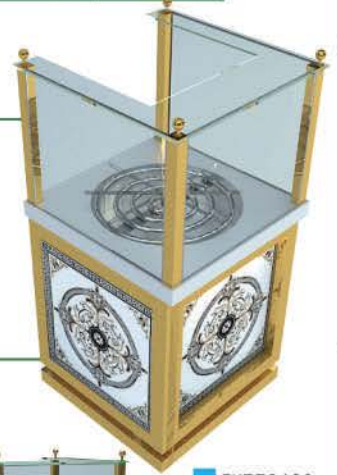

■ EK770402



EK770401 (MARINA)
Granit-Seramik



EK770401 (FORENZA)
Granit-Seramik



EK770401 (DOLCE)
Granit-Seramik



EK770401 (VERONA)
Granit-Seramik



EK770401 (LEPARDO)
Granit-Seramik



SİPARİŞ VERİRKEN GRANİT-SERAMİK MODELİNİ BELİRTİNİZ.

PLEASE PICK CERAMIC MODEL WHEN ORDERING.



■ EK450555



■ EK650556



■ EK850557

GAZLI LAVTAŞLI IZGARALAR / LAVSTONE GRILLS

GAZMER CE BELGESİ KODU	KODU	ÜRÜN ADI	EBAT (cm)	AĞIRLIK	GÜÇ	NET	FİYAT
	CODE	PRODUCT NAME	DIM	WEIGHT	POWER	NET m ²	PRICE
BLav-01	EK450555	40'LİK LAVTAŞLI SET ÜSTÜ IZGARA COUNTER TOP LAVSTONE GRILL	40x60x25	30 KG	8 KW 20 mbar/NG	0,06	500 €
BLav-01	EK650556	60'LİK LAVTAŞLI SET ÜSTÜ IZGARA COUNTER TOP LAVSTONE GRILL	60x60x25	45 KG	8 KW 20 mbar/NG	0,08	650 €
BLav-02	EK850557	80'LİK LAVTAŞLI SET ÜSTÜ IZGARA COUNTER TOP LAVSTONE GRILL	80x60x25	55 KG	16 KW 20 mbar/NG	0,11	800 €

AÇIKLAMALAR \ DESCRIPTIONS



TR

ENG

IZGARA

- Emniyet ventili valf.
- Paslanmaz çelik gövde.
- LPG ve doğal gaz uyumlu.
- Ayarlanabilir ayaklar.
- Homojen pişirme yüzeyi.
- Yağ toplama kanalı, boşaltma çekmecesini.
- Kolay temizlenebilir.

GRILL

- Safety valve.
- Stainless steel body
- LPG and natural gas compatible.
- Adjustable feet.
- Homogeneous cooking surface.
- Oil collector, drain drawer.
- Easy to clean.



"GÜVENLE PİŞİREBİLECEĞİNİZ LEZZETLİ ETLER"



TURUNCU
ORANGE

SARI
YELLOW

SİYAH
BLACK

KIRMIZI
RED

Ürünlerde kullanılan boya "Elektrostatik Toz Boya" dir.
The paint used in the products is "Electrostatic Powder Paint"



SİPARİŞ VERİRKEN RENK TERCİHİNİZİ BELİRTİNİZ.

PLEASE SELECT COLOR WHEN ORDERING.



40x50 cm	65 €
60x50 cm	90 €
80x50 cm	110 €



MİL IZGARA
MILE GRILL

Ürün standart olarak oluklu ızgara ile beraber gelmektedir.
Mil ızgara istediğiniz takdirde siparişinizde belirtiniz.

The product comes with a ribbed grill as standard.
Please specify if you want a mile grill when ordering



EK920601



EK950651

TEK KATLI İSKENDER OCAKLARI / SINGLE FLOOR İSKENDER COOKERS

GAZMER
CE BELGESİ
KODU

KODU CODE	ÜRÜN ADI PRODUCT NAME	EBAT (cm) DIM	AĞIRLIK WEIGHT	GÜÇ POWER	NET NET m ³	FİYAT PRICE
BGO-02	EK920601	90'LİK İSKENDER OCAĞI ISKENDER COOKER	90x28x20	10 KG	5 KW 20 mbar/NG	0,05 375 €
BGO-02	EK120602	120'LİK İSKENDER OCAĞI ISKENDER COOKER	120x28x20	13 KG	5 KW 20 mbar/NG	0,07 480 €
BGO-02	EK120603	150'LİK İSKENDER OCAĞI ISKENDER COOKER	150x28x20	16 KG	5 KW 20 mbar/NG	0,08 550 €
BGO-03	EK220604	200'LÜK İSKENDER OCAĞI ISKENDER COOKER	200x28x20	20 KG	7,5 KW 20 mbar/NG	0,11 750 €

AÇIKLAMALAR \ DESCRIPTIONS



TR

TEK KATLI İSKENDER OCAĞI

- Emniyet ventili valf.
- LPG ve doğal gaz uyumlu.
- Ayarlanabilir ayaklar.
- Kolay temizlenebilir ve hijyeniktir.
- Paslanmaz çelik gövde.

ENG

SINGLE FLOOR İSKENDER COOKERS

- Safety valve.
- LPG and natural gas compatible.
- Adjustable feet.
- Easy to clean and hygienic.
- Stainless steel body.

ÇİFT KATLI İSKENDER OCAKLARI / DOUBLE FLOOR İSKENDER COOKERS

GAZMER
CE BELGESİ
KODU

KODU CODE	ÜRÜN ADI PRODUCT NAME	EBAT (cm) DIM	AĞIRLIK WEIGHT	GÜÇ POWER	NET NET m ³	FİYAT PRICE
BGO-04	EK950651	90'LİK İSKENDER OCAĞI ISKENDER COOKER	90x56x35	15 KG	10 KW 20 mbar/NG	0,05 800 €
BGO-04	EK150652	120'LİK İSKENDER OCAĞI ISKENDER COOKER	120x56x35	20 KG	10 KW 20 mbar/NG	0,07 1.025 €
BGO-04	EK150653	150'LİK İSKENDER OCAĞI ISKENDER COOKER	150x56x35	25 KG	10 KW 20 mbar/NG	0,08 1.175 €
BGO-06	EK250654	200'LÜK İSKENDER OCAĞI ISKENDER COOKER	200x56x35	30 KG	15 KW 20 mbar/NG	0,11 1.500 €



İSTENİLEN ÖLÇÜLERDE İMALAT YAPILABİLMEKTEDİR.
MANUFACTURING CAN BE MADE IN REQUIRED SIZES.





EK740151

GAZLI SALAMANDER IZGARA / GAS SALAMANDER GRILL

GAZMER
CE BELGESİ
KODU

BP-02

BP-02

KODU CODE	ÜRÜN ADI PRODUCT NAME	EBAT (cm) DIM	AĞIRLIK WEIGHT	GÜÇ POWER	NET NET m ³	FİYAT PRICE
EK740151	GAZLI SALAMANDER GAS SALAMANDER GRILL	75x40x55	25 KG	10,8 KW 20 mbar/NG	0,16	565 €
EK140152	GAZLI SALAMANDER GAS SALAMANDER GRILL	105x40x55	35 KG	10,8 KW 20 mbar/NG	0,23	685 €

AÇIKLAMALAR \ DESCRIPTIONS



TR

ENG

SALAMANDER IZGARA

- Emniyet ventili valf.
- LPG ve doğal gaz uyumlu.
- Ayarlanabilir ayaklar.
- Kolay temizlenebilir ve hijyeniktir.
- Paslanmaz çelik gövde.
- Portatif ızgara ile yükseklik ayarı yapabilmek

SALAMANDER GRILL

- Safety valve.
- LPG and natural gas compatible.
- Adjustable feet.
- Easy to clean and hygienic.
- Stainless steel body.
- Different high adjustments by portable grill

ELEKTRİKLİ SALAMANDER IZGARA / ELECTRICAL SALAMANDER GRILL

KODU CODE	ÜRÜN ADI PRODUCT NAME	EBAT (cm) DIM	AĞIRLIK WEIGHT	GÜÇ POWER	NET NET m ³	FİYAT PRICE
EK740151	ELEKTRİKLİ SALAMANDER ELECTRICAL SALAMANDER GRILL	75x40x55	25 KG	2,4 KW 220V-50Hz	0,16	656 €
EK140152	ELEKTRİKLİ SALAMANDER ELECTRICAL SALAMANDER GRILL	105x40x55	35 KG	3,6 KW 220V-50Hz	0,23	685 €



İSTENİLEN ÖLÇÜLERDE İMALAT YAPILABİLMEKTEDİR.
MANUFACTURING CAN BE MADE IN REQUIRED SIZES.

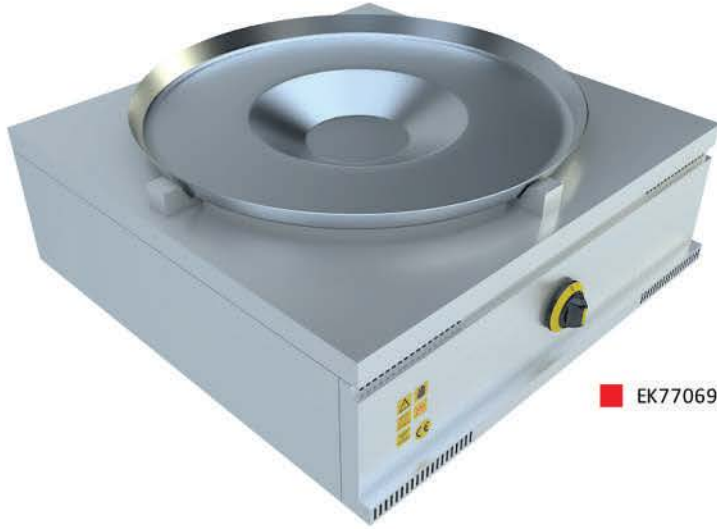

■ EK770690

TANTUNİ OCAKLARI / TANTUNI COOKERS

GAZMER
CE BELGESİ
KODU

BYO-01

BYO-01

BTR-02

BTR-02

KODU CODE	ÜRÜN ADI PRODUCT NAME	EBAT (cm) DIM	AĞIRLIK WEIGHT	GÜÇ POWER	NET NET m ³	FİYAT PRICE
■ EK770690	SET ÜSTÜ TANTUNİ OCAĞI COUNTERTOP TANTUNI COOKER	70x70x30	20 KG	7 KW 20 mbar/NG	0,15	500 €
■ EK880691	SET ÜSTÜ TANTUNİ OCAĞI COUNTERTOP TANTUNI COOKER	80x80x30	23 KG	7 KW 20 mbar/NG	0,20	550 €
■ EK170692	SET ÜSTÜ TANTUNİ OCAĞI COUNTERTOP TANTUNI COOKER	150x70x30	38 KG	14 KW 20 mbar/NG	0,29	875 €
■ EK180693	SET ÜSTÜ TANTUNİ OCAĞI COUNTERTOP TANTUNI COOKER	165x80x30	41 KG	14 KW 20 mbar/NG	0,40	940 €

AÇIKLAMALAR \ DESCRIPTIONS



TR

ENG

TANTUNİ OCAĞI

- ø 70 cm Tantuni tepsisi dahildir.
- Emniyet ventili valf.
- LPG ve doğal gaz uyumlu.
- Ayarlanabilir ayaklar.
- Kolay temizlenebilir ve hijyeniktir.
- Paslanmaz çelik gövde.

TANTUNI COOKER

- ø 70 cm Tantuni plate
- Safety valve.
- LPG and natural gas compatible.
- Adjustable feet.
- Easy to clean and hygienic.
- Stainless steel body.



■ EK170691



İSTENİLEN ÖLÇÜLERDE İMALAT YAPILABİLMEKTEDİR.
MANUFACTURING CAN BE MADE IN REQUIRED SIZES.

BEKA
ENDÜSTRİYEL MUTFAK

f /beka.mutfak

ig /bekamutfak

www.bekamutfak.com.tr



BU SAYFADA BULUNAN ÜRÜNLER MOTORLUDUR.
BU SEBEPLE HER BİR ÜRÜN 220V-50Hz ELEKTRİK
BAĞLANTISI (PRİZ) GEREKSİNİMİ DUYMAKTADIR.

**ALL PRODUCT WITH ENGINE ON THIS PAGE.
THE PRODUCTS IN THIS PAGE NEED AN
ELECTRICAL CONNECTION - 220V-50Hz**



■ EK560921

GAZLI MOTORLU LAVTAŞLI DÖNER OCAKLARI / GAS SHAWARMA COOKERS WITH ENGINE AND LAVSTONE

GAZMER
CE BELGESİ
KODU

BLD-04

KODU CODE	ÜRÜN ADI PRODUCT NAME	EBAT (cm) DIM	AĞIRLIK WEIGHT	GÜÇ POWER	NET NET m ³	FİYAT PRICE
■ EK560921	4'LÜ LAVTAŞLI DÖNER OCAĞI SHAWARMA COOKER WITH LAVSTONE	65x85x115	21 KG	12 KW 20 mbar/NG	0,63	3.000 €

AÇIKLAMALAR \ DESCRIPTIONS



TR

LAVTAŞLI DÖNER OCAĞI

- Altan motorlu sistem
- Döner kesme makinesi için 220V priz
- Emniyet ventili valf.
- LPG ve doğal gaz uyumlu.
- Alev denetleme tertibatı.
- Kolay temizlenebilir yağ tepsisi.
- Paslanmaz çelik gövde.

ENG

SHAWARMA COOKER WITH LAVSTONE

- Bottom engine system
- 220V Socket for shawarma cutting machine
- Safety valve.
- LPG and natural gas compatible.
- Flame monitoring device.
- Easy to clean oil tray.
- Stainless steel body.



! HER İKİ TARAFTA HAREKETLİ
ALEV KORUMA SAÇLARI
FIRE PROTECTION SHEET
DOUBLE-SIDED

! DÖNER KESME MAKİNENİZİ
BURDAKI PRİZE BAĞLAYARAK
KOLAYCA KESİM YAPABİLİRSİNİZ.

SHAWARMA CUTTING MACHINE
CONNECTING TO THE SOCKET
YOU CAN EASILY CUT TO SHAWARMA.



■ EK560901



■ EK560902

GAZLI MOTORLU DÖNER OCAKLARI / GAS SHAWARMA COOKERS WITH ENGINE

GAZMER
CE BELGESİ
KODU

BDNR-03

BDNR-04

BDNR-05

KODU CODE	ÜRÜN ADI PRODUCT NAME	EBAT (cm) DIM	AĞIRLIK WEIGHT	GÜÇ POWER	NET NET m ³	FİYAT PRICE
EK560901	3'LÜ MOTORLU DÖNER OCAĞI SHAWARMA COOKER	50x60x90	35 KG	9 KW 20 mbar/NG	0,27	1.250 €
EK560902	4'LÜ MOTORLU DÖNER OCAĞI SHAWARMA COOKER	50x60x110	45 KG	12 KW 20 mbar/NG	0,33	1.400 €
EK560903	5'Lİ MOTORLU DÖNER OCAĞI SHAWARMA COOKER	50x60x130	55 KG	15 KW 20 mbar/NG	0,39	1.600 €

AÇIKLAMALAR \ DESCRIPTIONS



TR

ENG

DÖNER OCAĞI

- Alttan motorlu sistem
- Döner kesme makinesi için 220V priz
- Emniyet ventili valf.
- LPG ve doğal gaz uyumlu.
- Alev denetleme tertibatı.
- Kolay temizlenebilir yağ tepsisi.
- Paslanmaz çelik gövde.

SHAWARMA COOKER

- Bottom engine system
- 220V Socket for shawarma cutting machine
- Safety valve.
- LPG and natural gas compatible.
- Flame monitoring device.
- Easy to clean oil tray.
- Stainless steel body.

■ EK560903



BU SAYFADA BULUNAN ÜRÜNLER MOTORLUDUR.
BU SEBEPLERİ HER BİR ÜRÜN 220V-50Hz ELEKTRİK
BAĞLANTISI (PRİZ) GEREKSİNİMİ DUYMAKTADIR.

ALL PRODUCT WITH ENGINE ON THIS PAGE.
THE PRODUCTS IN THIS PAGE NEED AN
ELECTRICAL CONNECTION - 220V-50Hz



EK860674



EK160676

BAZLAMA OCAKLARI / BAZLAMA COOKERS

GAZMER CE BELGESİ KODU	KODU CODE	ÜRÜN ADI PRODUCT NAME	EBAT (cm) DIM	AĞIRLIK WEIGHT	GÜÇ POWER	NET NET m ³	FİYAT PRICE
BP-02	EK860674	SET ÜSTÜ BAZLAMA OCAĞI COUNTERTOP BAZLAMA COOKER	80x60x22	17 KG	10,8 KW 20 mbar/NG	0,1	700 €
BP-02	EK160675	SET ÜSTÜ BAZLAMA OCAĞI COUNTERTOP BAZLAMA COOKER	100x60x22	21 KG	10,8 KW 20 mbar/NG	0,13	850 €
BP-03	EK160676	SET ÜSTÜ BAZLAMA OCAĞI COUNTERTOP BAZLAMA COOKER	125x60x22	28 KG	16,2 KW 20 mbar/NG	0,17	1.000 €
BP-02	EK860677	TABAN RAFLI BAZLAMA OCAĞI COUNTERTOP BAZLAMA COOKER	80x60x85	24 KG	10,8 KW 20 mbar/NG	0,4	800 €
BP-02	EK160678	TABAN RAFLI BAZLAMA OCAĞI COUNTERTOP BAZLAMA COOKER	100x60x85	30 KG	10,8 KW 20 mbar/NG	0,51	1.000 €
BP-03	EK160679	TABAN RAFLI BAZLAMA OCAĞI COUNTERTOP BAZLAMA COOKER	125x60x85	38 KG	16,2 KW 20 mbar/NG	0,64	1.150 €

AÇIKLAMALAR \ DESCRIPTIONS



TR

BAZLAMA OCAĞI

- ST 52 - 5 mm sac
- Düz üst pleyt sayesinde dengeli pişirme
- Emniyet ventili valf.
- LPG ve doğal gaz uyumlu.
- Ayarlanabilir ayaklar.
- Kolay temizlenebilir ve hijyeniktir.
- Paslanmaz çelik gövde.

ENG

BAZLAMA COOKER

- ST 52 - 5 mm plate
- Balanced cooking by flat plate
- Safety valve.
- LPG and natural gas compatible.
- Adjustable feet.
- Easy to clean and hygienic.
- Stainless steel body.



EK860677



EK160679





EK450951

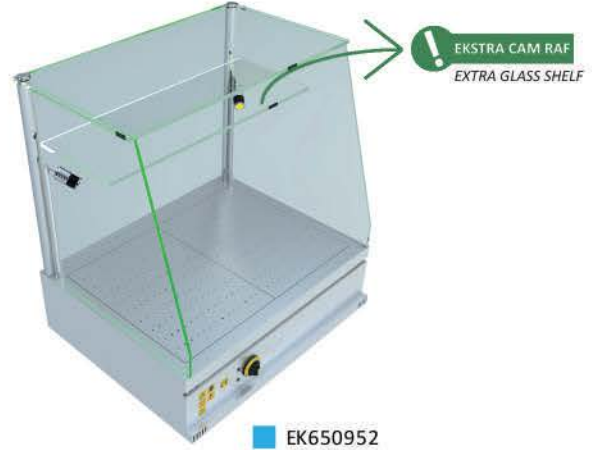

EK650952

ISLAK HAMBURGER MUHAFAZA / WET HAMBURGER STORAGE

KODU CODE	ÜRÜN ADI PRODUCT NAME	EBAT (cm) DIM	AĞIRLIK WEIGHT	GÜÇ POWER	NET NET m ³	FİYAT PRICE
EK450951	40'LİK ISLAK HAMBURGER MUHAFAZA 40 CM WET HAMBURGER STORAGE	40x55x20/60	11 KG	2 KW 220V-50Hz	0,04	400 €
EK650952	60'LİK ISLAK HAMBURGER MUHAFAZA 60 CM WET HAMBURGER STORAGE	60x55x20/60	14 KG	2 KW 220V-50Hz	0,07	500 €
EK850953	80'LİK ISLAK HAMBURGER MUHAFAZA 80 CM WET HAMBURGER STORAGE	80x55x20/60	17 KG	2,5 KW 220V-50Hz	0,09	600 €

AÇIKLAMALAR \ DESCRIPTIONS



TR

ENG

ISLAK HAMBURGER MUHAFAZA

- Paslanmaz çelik gövde.
- Elektrikli sulu ısıtma sistemi
- Paslanmaz argon kaynaklı sızdırmaz havuz
- Kolay temizlenebilir.
- Demonte cam sistemi.
- Spot aydınlatma.

WET HAMBURGER STORAGE

- Stainless steel body.
- Electrical hot water system.
- Stainless argon welded pool.
- Easy to clean.
- Mounted glass system.
- Spot lighting.

EKOSET / SET ÜSTÜ 1/1 BENMARI

ECOSET / COUNTERTOP 1/1 BAIN MARIES

EKOSET
ECOSET



EK460751



EK760752

1/1-150 SET ÜSTÜ BENMARİLER / 1/1-150 COUNTER TOP BAIN MARIES

KODU CODE	ÜRÜN ADI PRODUCT NAME	EBAT (cm) DIM	AĞIRLIK WEIGHT	GÜÇ POWER	NET NET m ³	FİYAT PRICE
EK460751	(1xGN1/1) SET ÜSTÜ BENMARI COUNTER TOP BAIN MARIE	41x61x25	10 KG	2,5 KW 220V-50Hz	0,06	160 €
EK760752	(2xGN1/1) SET ÜSTÜ BENMARI COUNTER TOP BAIN MARIE	74x61x25	13 KG	2,5 KW 220V-50Hz	0,11	220 €
EK160753	(3xGN1/1) SET ÜSTÜ BENMARI COUNTER TOP BAIN MARIE	106x61x25	16 KG	2,5 KW 220V-50Hz	0,16	270 €
EK160754	(4xGN1/1) SET ÜSTÜ BENMARI COUNTER TOP BAIN MARIE	140x61x25	20 KG	2,5 KW 220V-50Hz	0,21	300 €

AÇIKLAMALAR \ DESCRIPTIONS



TR

1/1-150 SET ÜSTÜ BENMARI

- Elektrikli rezistans ile ısıtma sistemi
- Paslanmaz çelik gövde.
- GN 1/1x150 cm küvete uygundur.
- Hijyenik ve kolay temizlenebilir.

ENG

1/1-150 COUNTER TOP BAIN MARIE

- Electrical heating system with resistance.
- Stainless steel body.
- GN 1/1x150 mm - suitable for gastronom.
- Easy to clean and hygienic.



KÜVETLER FİYATA DAHİL DEĞİLDİR. /
THE POTS ARE NOT INCLUDED IN THE PRICE.



EK340801



EK640802

1/2-150 SET ÜSTÜ BENMARİLER / 1/2-150 COUNTER TOP BAIN MARIÉS

KODU CODE	ÜRÜN ADI PRODUCT NAME	EBAT (cm) DIM	AĞIRLIK WEIGHT	GÜÇ POWER	NET NET m ³	FİYAT PRICE
EK340801	(1xGN1/2) SET ÜSTÜ BENMARİ COUNTER TOP BAIN MARIE	35x41x25	8 KG	2,5 KW 220V-50Hz	0,04	140 €
EK640802	(2xGN1/2) SET ÜSTÜ BENMARİ COUNTER TOP BAIN MARIE	62x41x25	11 KG	2,5 KW 220V-50Hz	0,06	170 €
EK840803	(3xGN1/2) SET ÜSTÜ BENMARİ COUNTER TOP BAIN MARIE	88x41x25	14 KG	2,5 KW 220V-50Hz	0,09	210 €
EK140804	(4xGN1/2) SET ÜSTÜ BENMARİ COUNTER TOP BAIN MARIE	115x41x25	18 KG	2,5 KW 220V-50Hz	0,12	240 €

AÇIKLAMALAR \ DESCRIPTIONS



TR

1/2-150 SET ÜSTÜ BENMARİ

- Elektrikli rezistans ile ısıtma sistemi
- Paslanmaz çelik gövde.
- GN 1/2x150 cm küvete uygundur.
- Hijyenik ve kolay temizlenebilir.

ENG

1/2-150 COUNTER TOP BAIN MARIE

- Electrical heating system with resistance
- Stainless steel body.
- GN 1/2x150 mm - suitable for gastronóm
- Easy to clean and hygienic.



KÜVETLER FİYATA DAHİL DEĞİLDİR. /
THE POTS ARE NOT INCLUDED IN THE PRICE.

EKOSET / SET ÜSTÜ KUMDA KAHVE OCAKLARI

ECOSSET / COUNTERTOP COFFEE COOKERS

EKOSET
ECOSSET



■ EK335051



■ EK335052

! SİLİS KUM
SILICA SAND

KUMDA KAHVE MAKİNELERİ / COFFEE COOKER WITH SAND

KODU CODE	ÜRÜN ADI PRODUCT NAME	EBAT (cm) DIM	AĞIRLIK WEIGHT	GÜÇ POWER	NET NET m ³	FİYAT PRICE
EK335051	MİNİ KUMDA KAHVE MINI COFFEE MACHINE IN SAND	40x35x20	4	2,5 KW 220V-50Hz	0,03	230 €
EK335052	MAKSİ KUMDA KAHVE MAXI COFFEE MACHINE IN SAND	60x40x20	7	5 KW 220V-50Hz	0,05	300 €

KUMDA KAHVE MAKİNELERİ - BAKIR / COFFEE COOKER WITH SAND - CHOPPER

KODU CODE	ÜRÜN ADI PRODUCT NAME	EBAT (cm) DIM	AĞIRLIK WEIGHT	GÜÇ POWER	NET NET m ³	FİYAT PRICE
EK335053	MİNİ KUMDA KAHVE - BAKIR MINI COFFEE COOKER WITH SAND	40x35x20	6	2,5 KW 220V-50Hz	0,03	300 €
EK335054	MAKSİ KUMDA KAHVE - BAKIR MAXI COFFEE COOKER WITH SAND	60x40x20	10	5 KW 220V-50Hz	0,05	350 €

AÇIKLAMALAR \ DESCRIPTIONS



TR

KUMDA KAHVE OCAKLARI

- Elektrikli rezistans ile ısıtma sistemi
- Paslanmaz çelik gövde.
- Opsiyonel bakır kaplama veya renk seçenekleri.
- Kum sayesinde dengeli pişirme.
- Hijyenik ve kolay temizlenebilir.

ENG

COFFEE COOKER WITH SAND

- Electrical heating system with resistance
- Stainless steel body.
- Color and chopper options.
- Equal cooking by sand.
- Easy to clean and hygienic.



SİLİS KUM FİYATA DAHİLDİR.
THE SAND IS INCLUDED IN THE PRICE..



ÖZEL EL İŞÇİLİĞİ BAKIR KAPLAMA
SPECIAL HAND MADE COPPER



■ EK335054



TURUNCU
ORANGE

SARI
YELLOW

SİYAH
BLACK

KIRMIZI
RED

Ürünlerde kullanılan boya "Elektrostatik Toz Boya" dir.
The paint used in the products is "Electrostatic Powder Paint"



SİPARİŞ VERİRKEN RENK TERCİHİNİZİ BELİRTİNİZ.
PLEASE SELECT COLOR WHEN ORDERING.



EK240701



EK450702

ELEKTRİKLİ FRİTÖZLER / ELECTRICAL FRYERS

KODU CODE	ÜRÜN ADI PRODUCT NAME	EBAT (cm) DIM	AĞIRLIK WEIGHT	GÜÇ POWER	NET m ³	FIYAT PRICE
EK240701	3 LT. TEKLİ FRİTÖZ SINGLE FRYER	25x50x20 /30	4 KG	2,5 KW 220V-50HZ	0,03	200 €
EK240702	3+3 LT. ÇİFTLİ FRİTÖZ SINGLE FRYER	45x50x20 /30	7,5 KG	5 KW 220V-50HZ	0,07	280 €
EK240703	5 LT. TEKLİ FRİTÖZ SINGLE FRYER	35x50x20 /30	5 KG	2,5 KW 220V-50HZ	0,05	230 €
EK240704	5+5 LT. ÇİFTLİ FRİTÖZ SINGLE FRYER	65x50x20 /30	10 KG	5 KW 220V-50HZ	0,1	300 €

AÇIKLAMALAR \ DESCRIPTIONS



TR

ENG

FRİTÖZ

- Elektrikli pişirme sistemi.
- Paslanmaz çelik gövde.
- Hijyenik ve kolay temizlenebilir.
- Gastronomik havuz.
- 60-200 °C ayarlı termostat.
- Ayarlanabilir ayaklar.

FRYER

- Electrical frying system.
- Stainless steel body.
- Easy to clean and hygienic.
- Gastronomic pool.
- 60-200 °C adjustable thermostat.
- Adjustable feet.



SET ÜSTÜ SÜPER MİNİ OCAKLAR/COUNTER TOP SUPER MINI COOKERS

GAZMER
CE BELGESİ
KODU

BGO-01

BGO-02

BGO-03

BGO-04

BGO-05

BGO-04

BGO-06

BGO-08

BGO-10

BGO-12

KODU CODE	ÜRÜN ADI PRODUCT NAME	EBAT (cm) DIM	AĞIRLIK WEIGHT	GÜÇ POWER	NET NET m ³	FİYAT PRICE
EK220841	1'Lİ SET ÜSTÜ SÜPER MİNİ OCAK COUNTER TOP SUPER MINI COOKER	28x28x13	4 KG	2,5 KW 20 mbar/NG	0,01	180 €
EK520842	2'Lİ SET ÜSTÜ SÜPER MİNİ OCAK COUNTER TOP SUPER MINI COOKER	56x28x13	7 KG	5 KW 20 mbar/NG	0,02	270 €
EK820843	3'LÜ SET ÜSTÜ SÜPER MİNİ OCAK COUNTER TOP SUPER MINI COOKER	80x28x13	12 KG	7,5 KW 20 mbar/NG	0,03	340 €
EK120844	4'LÜ SET ÜSTÜ SÜPER MİNİ OCAK COUNTER TOP SUPER MINI COOKER	105x28x13	19 KG	10 KW 20 mbar/NG	0,04	450 €
EK120846	5'Lİ SET ÜSTÜ SÜPER MİNİ OCAK COUNTER TOP SUPER MINI COOKER	125x28x13	22 KG	12,5 KW 20 mbar/NG	0,05	560 €
EK550846	4'LÜ SET ÜSTÜ SÜPER MİNİ OCAK COUNTER TOP SUPER MINI COOKER	56x56x13	19 KG	10 KW 20 mbar/NG	0,04	450 €
EK850847	6'Lİ SET ÜSTÜ SÜPER MİNİ OCAK COUNTER TOP SUPER MINI COOKER	80x56x13	28 KG	15 KW 20 mbar/NG	0,06	630 €
EK150848	8'Lİ SET ÜSTÜ SÜPER MİNİ OCAK COUNTER TOP SUPER MINI COOKER	105x56x13	35 KG	20 KW 20 mbar/NG	0,08	785 €
EK150849	10'LU SET ÜSTÜ SÜPER MİNİ OCAK COUNTER TOP SUPER MINI COOKER	125x56x13	41 KG	25 KW 20 mbar/NG	0,09	1.015 €
EK150850	12'Lİ SET ÜSTÜ SÜPER MİNİ OCAK COUNTER TOP SUPER MINI COOKER	150x56x13	50 KG	30 KW 20 mbar/NG	0,11	1.150 €

AÇIKLAMALAR \ DESCRIPTIONS



SET ÜSTÜ SÜPER MİNİ OCAK

- Emniyet ventili valf.
- LPG ve doğal gaz uyumlu.
- Sanayi tipi döküm (20x20 cm)
- Ayarlanabilir ayaklar.
- Kolay temizlenebilir ve hijyeniktir.
- Paslanmaz çelik gövde.

COUNTER TOP SUPER MINI COOKER

- Safety valve.
- LPG and natural gas compatible.
- Industrial casting (20x20 cm)
- Adjustable feet.
- Easy to clean and hygienic.
- Stainless steel body.

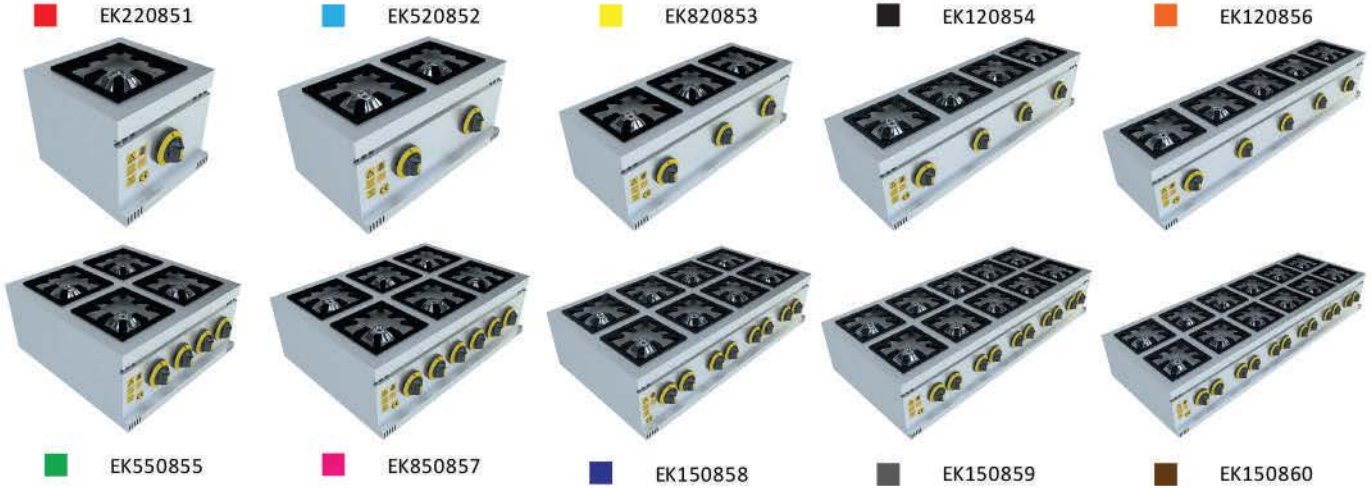

SET ÜSTÜ MİNİ OCAKLAR/COUNTERTOP MINI COOKERS

GAZMER CE BELGESİ KODU	KODU CODE	ÜRÜN ADI PRODUCT NAME	EBAT (cm) DIM	AĞIRLIK WEIGHT	GÜÇ POWER	NET NET m ³	FİYAT PRICE
BGO-01	EK220851	1'Lİ SET ÜSTÜ MİNİ OCAK COUNTERTOP MINI COOKER	28x28x20	5 KG	2,5 KW 20 mbar/NG	0,02	200 €
BGO-02	EK520852	2'Lİ SET ÜSTÜ MİNİ OCAK COUNTERTOP MINI COOKER	56x28x20	8 KG	5 KW 20 mbar/NG	0,03	300 €
BGO-03	EK820853	3'LÜ SET ÜSTÜ MİNİ OCAK COUNTERTOP MINI COOKER	80x28x20	13 KG	7,5 KW 20 mbar/NG	0,04	375 €
BGO-04	EK120854	4'LÜ SET ÜSTÜ MİNİ OCAK COUNTERTOP MINI COOKER	105x28x20	20 KG	10 KW 20 mbar/NG	0,06	500 €
BGO-04	EK550855	4'LÜ SET ÜSTÜ MİNİ OCAK COUNTERTOP MINI COOKER	56x56x20	20 KG	10 KW 20 mbar/NG	0,06	500 €
BGO-05	EK120856	5'Lİ SET ÜSTÜ MİNİ OCAK COUNTERTOP MINI COOKER	125x28x20	23 KG	12,5 KW 20 mbar/NG	0,07	625 €
BGO-06	EK850857	6'Lİ SET ÜSTÜ MİNİ OCAK COUNTERTOP MINI COOKER	80x56x20	30 KG	15 KW 20 mbar/NG	0,09	700 €
BGO-08	EK150858	8'Lİ SET ÜSTÜ MİNİ OCAK COUNTERTOP MINI COOKER	105x56x20	38 KG	20 KW 20 mbar/NG	0,12	875 €
BGO-10	EK150859	10'LÜ SET ÜSTÜ MİNİ OCAK COUNTERTOP MINI COOKER	125x56x20	45 KG	25 KW 20 mbar/NG	0,14	1.125 €
BGO-12	EK150860	12'Lİ SET ÜSTÜ MİNİ OCAK COUNTERTOP MINI COOKER	150x56x20	55 KG	30 KW 20 mbar/NG	0,17	1.275 €

AÇIKLAMALAR \ DESCRIPTIONS



TR

ENG

SET ÜSTÜ MİNİ OCAK

- Emniyet ventili valf.
- LPG ve doğal gaz uyumlu.
- Sanayi tipi döküm (20x20 cm)
- Ayarlanabilir ayaklar.
- Kolay temizlenebilir ve hijyeniktir.
- Paslanmaz çelik gövde.

COUNTERTOP MINI COOKER

- Safety valve.
- LPG and natural gas compatible.
- Industrial casting (20x20 cm)
- Adjustable feet.
- Easy to clean and hygienic.
- Stainless steel body.

EKOSET / SET ÜSTÜ MİDİ OCAKLAR (LOKANTA OCAKLARI)

ECOSSET / COUNTERTOP MIDI COOKER

EKOSET
ECOSSET



EK540871



EK940872

SET ÜSTÜ MİDİ OCAKLAR / COUNTERTOP MIDI COOKERS

GAZMER CE BELGESİ KODU	KODU CODE	ÜRÜN ADI PRODUCT NAME	EBAT (cm) DIM	AĞIRLIK WEIGHT	GÜÇ POWER	NET NET m ³	FİYAT PRICE
BYO-01	EK540871	1'Lİ SET ÜSTÜ MİDİ OCAK COUNTERTOP MIDI COOKER	50x47x25	15 KG	7 KW 20 mbar/NG	0,06	250 €
BTR-02	EK940872	2'Lİ SET ÜSTÜ MİDİ OCAK COUNTERTOP MIDI COOKER	90x47x25	25 KG	14 KW 20 mbar/NG	0,1	425 €
BTR-02	EK590873	2'Lİ SET ÜSTÜ MİDİ OCAK COUNTERTOP MIDI COOKER	50x90x25	27 KG	14 KW 20 mbar/NG	0,11	425 €
BTR-03	EK140874	3'LÜ SET ÜSTÜ MİDİ OCAK COUNTERTOP MIDI COOKER	140x47x25	40 KG	21 KW 20 mbar/NG	0,16	575 €

AÇIKLAMALAR \ DESCRIPTIONS



TR
ENG

SET ÜSTÜ MİDİ OCAK

- Emniyet ventili valf.
- LPG ve doğal gaz uyumlu.
- Sanayi tipi döküm (33x33 cm)
- Ayarlanabilir ayaklar.
- Kolay temizlenebilir ve hijyeniktir.
- Paslanmaz çelik gövde.

COUNTERTOP MIDI COOKER

- Safety valve.
- LPG and natural gas compatible.
- Industrial casting (33x33 cm)
- Adjustable feet.
- Easy to clean and hygienic.
- Stainless steel body.



EK590873



EK140874

EKOSET / TABAN RAFLI MİDİ OCAKLAR (LOKANTA OCAKLARI)

ECOSET / MIDI COOKER WITH BOTTOM SHELF

EKOSET
ECOSET



■ EK540881



■ EK940882



■ EK590883

TABAN RAFLI MİDİ OCAKLAR / MIDI COOKERS WITH BOTTOM SHELF

GAZMER CE BELGESİ KODU	KODU CODE	ÜRÜN ADI PRODUCT NAME	EBAT (cm) DIM	AĞIRLIK WEIGHT	GÜÇ POWER	NET NET m ³	FİYAT PRICE
BYO-01	EK540881	1'Lİ TABAN RAFLI MİDİ OCAK MIDI COOKER WITH BOTTOM SHELF	50x47x85	10	7 KW 20 mbar/NG	0,2	350 €
BTR-02	EK940882	2'Lİ TABAN RAFLI MİDİ OCAK MIDI COOKER WITH BOTTOM SHELF	90x47x85	20	14 KW 20 mbar/NG	0,35	500 €
BTR-02	EK590883	2'Lİ TABAN RAFLI MİDİ OCAK MIDI COOKER WITH BOTTOM SHELF	50x90x85	20	14 KW 20 mbar/NG	0,38	500 €
BTR-03	EK140884	3'LÜ TABAN RAFLI MİDİ OCAK MIDI COOKER WITH BOTTOM SHELF	140x47x85	30	21 KW 20 mbar/NG	0,56	700 €
BTR-04	EK990885	4'LÜ TABAN RAFLI MİDİ OCAK MIDI COOKER WITH BOTTOM SHELF	90x90x85	40	28 KW 20 mbar/NG	0,69	850 €
BTR-06	EK190886	6'Lİ TABAN RAFLI MİDİ OCAK MIDI COOKER WITH BOTTOM SHELF	140x90x85	50	42 KW 20 mbar/NG	1,01	1.200 €
BTR-08	EK190887	8'Lİ TABAN RAFLI MİDİ OCAK MIDI COOKER WITH BOTTOM SHELF	180x90x85	60	56 KW 20 mbar/NG	1,4	1.500 €

AÇIKLAMALAR \ DESCRIPTIONS



TR

TABAN RAFLI MİDİ OCAK

- Emniyet ventili valf.
- LPG ve doğal gaz uyumlu.
- Sanayi tipi döküm (33x33 cm)
- Ayarlanabilir ayaklar.
- Kolay temizlenebilir ve hijyeniktir. Kırıntı tava.
- Paslanmaz çelik gövde.
- 30x30 paslanmaz profil ayak.

ENG

MIDI COOKER WITH BOTTOM SHELF

- Safety valve.
- LPG and natural gas compatible.
- Industrial casting (33x33 cm)
- Adjustable feet.
- Easy to clean and hygienic. Crumb pan.
- Stainless steel body.
- 30x30 stainless profile feet.



■ EK140884



■ EK990885



■ EK190886



EKOSET / TABAN RAFLI MAKS OCAKLAR

ECOSET / MAXI COOKER WITH BOTTOM SHELF

EKOSET
ECOSET



■ EK160891



■ EK160892

TABAN RAFLI MAKS OCAKLAR / MAXI COOKERS WITH BOTTOM SHELF

GAZMER CE BELGESİ KODU	KODU CODE	ÜRÜN ADI PRODUCT NAME	EBAT (cm) DIM	AĞIRLIK WEIGHT	GÜÇ POWER	NET NET m ³	FİYAT PRICE
BTR-02	EK160891	2'Lİ TABAN RAFLI MAKS OCAK MAXI COOKER WITH BOTTOM SHELF	100x60x85	50 KG	14 KW 20 mbar/NG	0,51	800 €
BTR-03	EK160892	3'LÜ TABAN RAFLI MAKS OCAK MAXI COOKER WITH BOTTOM SHELF	150x60x85	60 KG	21 KW 20 mbar/NG	0,76	975 €
BTR-04	EK110893	4'LÜ TABAN RAFLI MAKS OCAK MAXI COOKER WITH BOTTOM SHELF	100x100x85	80 KG	28 KW 20 mbar/NG	0,85	1.125 €
BTR-06	EK110894	6'Lİ TABAN RAFLI MAKS OCAK MAXI COOKER WITH BOTTOM SHELF	150x100x85	100 KG	42 KW 20 mbar/NG	1,27	1.500 €
BTR-08	EK210895	8'Lİ TABAN RAFLI MAKS OCAK MAXI COOKER WITH BOTTOM SHELF	200x100x85	130 KG	56 KW 20 mbar/NG	1,7	1.875 €

AÇIKLAMALAR \ DESCRIPTIONS



TR

ENG

TABAN RAFLI MAKS OCAK

- Emniyet ventili valf.
- LPG ve doğal gaz uyumlu.
- Sanayi tipi döküm (40x40 cm)
- Ayarlanabilir ayaklar.
- Kolay temizlenebilir ve hijyeniktir. Kırınıt tavalı.
- Paslanmaz çelik gövde.
- 40x40 paslanmaz profil ayak.

MAXI COOKER WITH BOTTOM SHELF

- Safety valve.
- LPG and natural gas compatible.
- Industrial casting (40x40 cm)
- Adjustable feet.
- Easy to clean and hygienic.
- Stainless steel body.
- 40x40 stainless profile feet.



■ EK110893



■ EK110894

BEKA
ENDÜSTRİYEL MUTFAK



■ EK160731



■ EK160732

FIRINLI KUZİNE / GAS RANGES WITH OVEN

GAZMER CE BELGESİ KODU	KODU CODE	ÜRÜN ADI PRODUCT NAME	EBAT (cm) DIM	AĞIRLIK WEIGHT	GÜÇ POWER	NET NET m ³	FİYAT PRICE
BK-02	EK160731	2'Lİ KUZİNE GAS RANGES	100x60x85	90 KG	19,5 KW 20 mbar/NG	0,51	1.325 €
BK-03	EK160732	3'LÜ KUZİNE GAS RANGES	150x60x85	110 KG	26,5 KW 20 mbar/NG	0,76	1.500 €
BK-04	EK160733	4'LÜ KUZİNE GAS RANGES	80x80x85	135 KG	33,5 KW 20 mbar/NG	0,54	1.750 €
BK-04	EK160734	4'LÜ KUZİNE GAS RANGES	100x100x85	155 KG	33,5 KW 20 mbar/NG	0,85	1.875 €
BK-06	EK160735	6'Lİ KUZİNE GAS RANGES	150x100x85	175 KG	47,5 KW 20 mbar/NG	1,27	2.775 €
BK-08	EK160736	8'Lİ KUZİNE (2 FIRINLI) GAS RANGES (2 OVEN)	200x100x85	200 KG	67 KW 20 mbar/NG	1,7	3.500 €

AÇIKLAMALAR \ DESCRIPTIONS



İSTENİLEN ÖLÇÜLERDE İMALAT YAPILABİLMEKTEDİR.
MANUFACTURING CAN BE MADE IN REQUIRED SIZES.

TR

FIRINLI KUZİNE

- 2 Katlı fırın gn 2/1x2 kapasiteli
- Emniyet ventili valf.
- LPG ve doğal gaz uyumlu.
- Sanayi tipi döküm (40x40 cm)
- Ayarlanabilir ayaklar.
- Kolay temizlenebilir ve hijyeniktir.
- Paslanmaz çelik gövde.

GAS RANGES

- 2 floored oven gn 2/1x2 cap.
- Safety valve.
- LPG and natural gas compatible.
- Industrial casting (40x40 cm)
- Adjustable feet.
- Easy to clean and hygienic.
- Stainless steel body.

ENG



■ EK160733

■ EK160734



■ EK160735



■ EK160736

EKOSET / FIRINLI MAKS KOMBİNASYON KUZİNELER
ECOSSET / COMBINATION GAS RANGES WITH OVEN



EK111011

FIRINLI KOMBİNASYON KUZİNELER / COMBINATION GAS RANGES WITH OVEN

GAZMER CE BELGESİ KODU	KODU CODE	ÜRÜN ADI PRODUCT NAME	EBAT (cm) DIM	AĞIRLIK WEIGHT	GÜÇ POWER	NET NET m ³	FİYAT PRICE
BK-04	EK111011	1x(60x60)+2x(40x40) KUZİNE GAS RANGES	150x100x85	100	33,5 KW 20 mbar/NG	1,27	2.625 €
BK-08	EK211012	1x(60x60)4x(40x40)KUZİNE (2 FIRINLI) GAS RANGES	200x100x85	110	47,5 KW 20 mbar/NG	1,7	3.750 €
BK-08	EK211013	2x(60x60)2x(40x40)KUZİNE (2 FIRINLI) GAS RANGES (2 OVEN)	200x100x85	130	47,5 KW 20 mbar/NG	1,7	4.000 €

AÇIKLAMALAR \ DESCRIPTIONS



TR

FIRINLI KUZİNE

- 2 Katlı fırın gn 2/1x 2 kapasiteli
- Emniyet ventili valf.
- LPG ve doğal gaz uyumlu.
- Sanayi tipi döküm (40x40 cm)(60x60)
- Ayarlanabilir ayaklar.
- Kolay temizlenebilir ve hijyeniktir.
- Paslanmaz çelik gövde.

ENG

GAS RANGES WITH OVEN

- 2 floored oven gn 2/1x2 cap.
- Safety valve.
- LPG and natural gas compatible.
- Industrial casting (40x40 cm)(60x60)
- Adjustable feet.
- Easy to clean and hygienic.
- Stainless steel body.



EK211012



EK211013



EK441051



EK671052

YER OCAKLARI / FLOOR COOKERS

GAZMER CE BELGESİ KODU	KODU CODE	ÜRÜN ADI PRODUCT NAME	EBAT (cm) DIM	AĞIRLIK WEIGHT	GÜÇ POWER	NET NET m ³	FİYAT PRICE
BYO-01	EK441051	TEK YANIŞLI YER OCAĞI SINGLE BURNER FLOOR COOKER	40x40x50	25 KG	7 KW 20 mbar/NG	0,08	320 €
BYO-02	EK671052	ÇİFT YANIŞLI YER OCAĞI DOUBLE BURNER FLOOR COOKER	60x70x50	40 KG	12,5 KW 20 mbar/NG	0,21	400 €
BYO-03	EK781053	ÜÇ YANIŞLI YER OCAĞI TRIPLE BURNER FLOOR COOKER	70x80x50	65 KG	23,2 KW 20 mbar/NG	0,28	800 €
BYO-03	EK781054	DÖRT YANIŞLI YER OCAĞI FOUR BURNER FLOOR COOKER	70x90x50	70 KG	23,2 KW 20 mbar/NG	0,28	1.000 €

AÇIKLAMALAR \ DESCRIPTIONS



TR

ENG

YER OCAĞI

- Emniyet ventili valf.
- LPG ve doğal gaz uyumlu.
- Ayarlanabilir ayaklar.
- Kolay temizlenebilir ve hijyeniktir.
- Paslanmaz çelik gövde.
- EK441051 Kodlu ürün 40x40 döküm
- EK671052 ve EK781053 Kodlu ürün 60x60 döküm

FLOOR COOKER

- Safety valve.
- LPG and natural gas compatible.
- Adjustable feet.
- Easy to clean and hygienic.
- Stainless steel body
- EK441051 __ 40x40 casting
- EK671052 ve EK781053 __ 60x60 casting



EK781053



EK781054



EKOSET / KOMBİNASYON YANIŞLI YER OCAKLARI

ECOSSET / COMBINATION FLOOR COOKER

EKOSET
ECOSSET



■ EK441101



■ EK191102

KOMBİNASYON YER OCAKLARI / COMBINATION FLOOR COOKERS

GAZMER CE BELGESİ KODU	KODU CODE	ÜRÜN ADI PRODUCT NAME	EBAT (cm) DIM	AĞIRLIK WEIGHT	GÜÇ POWER	NET NET m ³	FİYAT PRICE
BTR-04	EK441101	1x(60x60)+2x(40x40) GAZLI OCAK FLOOR COOKER	130x90x50	50 KG	28 KW 20 mbar/NG	0,58	1.500 €
BTR-06	EK191102	1x(60x60)+4x(40x40) GAZLI OCAK FLOOR COOKER	180x90x50	60 KG	42 KW 20 mbar/NG	0,81	2.200 €
BTR-06	EK291103	2x(60x60)+2x(40x40) GAZLI OCAK FLOOR COOKER	200x90x50	70 KG	42 KW 20 mbar/NG	0,9	2.400 €
BTR-04	EK191104	2x(60x60) GAZLI OCAK FLOOR COOKER	150x80x50	80 KG	28 KW 20 mbar/NG	0,67	1.600 €

AÇIKLAMALAR \ DESCRIPTIONS



TR

ENG

YER OCAKLARI

- Emniyet ventili valf.
- LPG ve doğal gaz uyumlu.
- Ayarlanabilir ayaklar.
- Kolay temizlenebilir ve hijyeniktir.
- Paslanmaz çelik gövde.

FLOOR COOKER

- Safety valve.
- LPG and natural gas compatible.
- Adjustable feet.
- Easy to clean and hygienic.
- Stainless steel body.



■ EK291103



■ EK191104



EK710741



EK110742

PASTA BÖREK FIRINLARI / PASTRY OVENS

GAZMER
CE BELGESİ
KODU

BPB-02

BPB-03

BPB-03

KODU CODE	ÜRÜN ADI PRODUCT NAME	EBAT (cm) DIM	AĞIRLIK WEIGHT	GÜÇ POWER	NET NET m ³	FİYAT PRICE
EK710741	PASTA BÖREK FIRINI PASTRY OVEN	70x100x160	115 KG	8 KW 20 mbar/NG	1,12	1.400 €
EK110742	PASTA BÖREK FIRINI PASTRY OVEN	100x100x 160	140 KG	12 KW 20 mbar/NG	1,6	1.700 €
EK110743	PASTA BÖREK FIRINI PASTRY OVEN	110x110x 160	155 KG	12 KW 20 mbar/NG	1,9	1.850 €

AÇIKLAMALAR \ DESCRIPTIONS



TR

ENG

PASTA BÖREK FIRINI

- Emniyet ventili valf.
- LPG ve doğal gaz uyumlu.
- Ayarlanabilir ayaklar.
- Kolay temizlenebilir ve hijyeniktir.
- Paslanmaz çelik gövde.

PASTRY OVEN

- Safety valve.
- LPG and natural gas compatible.
- Adjustable feet.
- Easy to clean and hygienic.
- Stainless steel body.



FY513921

55x13x60

BİÇAK STERİLİZASYON DOLABI

250 €

TR

ENG

KNIFE STERILIZATION

- Paslanmaz çelik gövdeli
- Özel ışık sayesinde dezenfekte etme özelliği
- Pleksiglas kilitli kapak
- 0-120 Dakika zaman ayarlı

- Stainless steel body
- Cleaning feature by special light
- Plexiglass cover with lock
- 0-120 Minute time settings



Pro
BEKA
ENDÜSTRİYEL MUTFAK

ÜRÜNLERİMİZLE, ÜRÜNLERİNİZİ GÜVENLE PIŞIREBİLİRSİNİZ.

BEKA ENDÜSTRİYEL MUTFAK OLARAK BÜTÜN ÜRÜNLERİMİZ GÜVENLİK SERTİFİKALI CE BELGELİDİR.



NÖTRSET İNDEKS

1-Çalışma Tezgahları	52
2-Evyeli Çalışma Tezgahları ve Yıkama Tezgahları	61
3-İstif Rafları	68
4-Duvar Dolapları ve Rafları, Askı Aparatları	72
5-Taşıma arabaları	74
6-Davlumbazlar	78

NÖTRSET / PROFİL KARKAS TEZGAHLAR

NOTRSET / PROFILE FORM WORK TABLES

NÖTRSET
NOTRSET



PROFİL KARKASLAR

PROFILE FORM WORK TABLES

EBAT (cm) DIM	KG	EBAT (cm) DIM	KG	EBAT (cm) DIM	KG	EBAT (cm) DIM	KG	EBAT (cm) DIM	KG
60x60x85	13	60x70x85	14	60x80x85	15	60x90x85	16	60x100x85	17
80x60x85	14	80x70x85	15	80x80x85	16	80x90x85	17	80x100x85	18
100x60x85	15	100x70x85	16	100x80x85	17	100x90x85	18	100x100x85	19
120x60x85	16	120x70x85	17	120x80x85	18	120x90x85	19	120x100x85	20
140x60x85	17	140x70x85	18	140x80x85	19	140x90x85	20	140x100x85	21
160x60x85	18	160x70x85	19	160x80x85	20	160x90x85	21	160x100x85	22
180x60x85	19	180x70x85	20	180x80x85	21	180x90x85	22	180x100x85	23
200x60x85	21	200x70x85	22	200x80x85	23	200x90x85	24	200x100x85	25
220x60x85	22	220x70x85	23	220x80x85	24	220x90x85	25	220x100x85	26
240x60x85	23	240x70x85	24	240x80x85	25	240x90x85	26	240x100x85	27
260x60x85	24	260x70x85	25	260x80x85	26	260x90x85	27	260x100x85	28
280x60x85	25	280x70x85	26	280x80x85	27	280x90x85	28	280x100x85	29

TABAN RAFLI PROFİL KARKASLAR

PROFILE FORM WORK TABLES WITH BOTTOM SHELF

EBAT (cm) DIM	KG	EBAT (cm) DIM	KG	EBAT (cm) DIM	KG	EBAT (cm) DIM	KG	EBAT (cm) DIM	KG
60x60x85	17	60x70x85	18	60x80x85	19	60x90x85	20	60x100x85	22
80x60x85	19	80x70x85	20	80x80x85	22	80x90x85	23	80x100x85	25
100x60x85	21	100x70x85	22	100x80x85	24	100x90x85	26	100x100x85	27
120x60x85	23	120x70x85	24	120x80x85	26	120x90x85	28	120x100x85	29
140x60x85	25	140x70x85	27	140x80x85	28	140x90x85	30	140x100x85	32
160x60x85	27	160x70x85	29	160x80x85	31	160x90x85	33	160x100x85	35
180x60x85	29	180x70x85	31	180x80x85	33	180x90x85	36	180x100x85	37
200x60x85	32	200x70x85	34	200x80x85	37	200x90x85	39	200x100x85	42
220x60x85	34	220x70x85	36	220x80x85	39	220x90x85	42	220x100x85	44
240x60x85	36	240x70x85	39	240x80x85	41	240x90x85	45	240x100x85	47
260x60x85	38	260x70x85	41	260x80x85	44	260x90x85	47	260x100x85	50
280x60x85	40	280x70x85	43	280x80x85	46	280x90x85	49	280x100x85	52

TABAN VE ARA RAFLI PROFİL KARKASLAR

PROFILE FORM WORK TABLES WITH BOTTOM AND MIDDLE SHELF

EBAT (cm) DIM	KG	EBAT (cm) DIM	KG	EBAT (cm) DIM	KG	EBAT (cm) DIM	KG	EBAT (cm) DIM	KG
60x60x85	20	60x70x85	22	60x80x85	23	60x90x85	25	60x100x85	27
80x60x85	23	80x70x85	25	80x80x85	27	80x90x85	29	80x100x85	31
100x60x85	26	100x70x85	28	100x80x85	32	100x90x85	33	100x100x85	35
120x60x85	29	120x70x85	31	120x80x85	35	120x90x85	37	120x100x85	40
140x60x85	32	140x70x85	35	140x80x85	38	140x90x85	41	140x100x85	44
160x60x85	35	160x70x85	38	160x80x85	42	160x90x85	45	160x100x85	48
180x60x85	39	180x70x85	42	180x80x85	45	180x90x85	49	180x100x85	52
200x60x85	43	200x70x85	45	200x80x85	50	200x90x85	54	200x100x85	58
220x60x85	46	220x70x85	48	220x80x85	53	220x90x85	58	220x100x85	62
240x60x85	49	240x70x85	52	240x80x85	58	240x90x85	62	240x100x85	67
260x60x85	52	260x70x85	56	260x80x85	61	260x90x85	66	260x100x85	71
280x60x85	55	280x70x85	60	280x80x85	65	280x90x85	70	280x100x85	75

AÇIKLAMALAR / DESCRIPTIONS

TR -Paslanmaz çelik gövde.
-Kolay temizlenebilir.
-Ayarlanabilir rotli ayaklar.
ENG -40x40 Profil ayaklar

-Stainless steel body.
-Easy to clean.
-Adjustable ball joint feet.
-40x40 mm Profile

ÇALIŞMA TEZGAHLARI
WORKING TABLES

EBAT (cm) DIM	KG
60x60x85	14
80x60x85	16
100x60x85	18
120x60x85	19
140x60x85	22
160x60x85	24
180x60x85	26
200x60x85	28
220x60x85	31
240x60x85	34
260x60x85	36
280x60x85	37

EBAT (cm) DIM	KG
60x70x85	15
80x70x85	18
100x70x85	19
120x70x85	21
140x70x85	24
160x70x85	27
180x70x85	28
200x70x85	30
220x70x85	34
240x70x85	38
260x70x85	39
280x70x85	41



TABAN RAFLI ÇALIŞMA TEZGAHLARI
WORKING TABLES WITH BOTTOM SHELF

EBAT (cm) DIM	KG
60x60x85	15
80x60x85	19
100x60x85	22
120x60x85	24
140x60x85	28
160x60x85	32
180x60x85	34
200x60x85	37
220x60x85	40
240x60x85	46
260x60x85	48
280x60x85	50

EBAT (cm) DIM	KG
60x70x85	17
80x70x85	21
100x70x85	24
120x70x85	26
140x70x85	31
160x70x85	36
180x70x85	38
200x70x85	41
220x70x85	45
240x70x85	51
260x70x85	54
280x70x85	57



TABAN VE ARA RAFLI ÇALIŞMA TEZGAHLARI
WORKING TABLES WITH BOTTOM AND MIDDLE SHELF

EBAT (cm) DIM	KG
60x60x85	18
80x60x85	23
100x60x85	27
120x60x85	30
140x60x85	35
160x60x85	39
180x60x85	43
200x60x85	46
220x60x85	50
240x60x85	57
260x60x85	60
280x60x85	63

EBAT (cm) DIM	KG
60x70x85	20
80x70x85	26
100x70x85	30
120x70x85	33
140x70x85	39
160x70x85	44
180x70x85	48
200x70x85	52
220x70x85	56
240x70x85	64
260x70x85	68
280x70x85	71



AÇIKLAMALAR \ DESCRIPTIONS

-Paslanmaz çelik gövde.
-Kolay temizlenebilir.
-Ayarlanabilir rotol ayaklar.
-40x40 Profil ayaklar

-Stainless steel body.
-Easy to clean.
-Adjustable ball joint feet.
-40x40 mm Profile

TR
ENG



1 Takım Tekertelek;

20 €

TR

ENG

-Paslanmaz çelik gövde.
-Kolay temizlenebilir.
-Ayarlanabilir rotli ayaklar.
-40x40 Profil ayaklar
-360° Dönebilen tekerler, 2frenli-2frensiz
-Tekerler ekstra ücretlendirilecektir.

-Stainless steel body.
-Easy to clean.
-Adjustable ball joint feet.
-40x40 mm Profile
-360° Rotating wheel, 2brake-2brakes
-Wheels will be extra charged.

HAREKETLİ ÇALIŞMA TEZGAHLARI
MOVABLE WORKING TABLES

EBAT (cm) DIM	KG
60x60x85	14
80x60x85	16
100x60x85	18
120x60x85	19
140x60x85	21
160x60x85	24
180x60x85	25
200x60x85	27
220x60x85	30
240x60x85	34
260x60x85	36
280x60x85	37

EBAT (cm) DIM	KG
60x70x85	15
80x70x85	17
100x70x85	19
120x70x85	21
140x70x85	24
160x70x85	26
180x70x85	28
200x70x85	30
220x70x85	33
240x70x85	37
260x70x85	39
280x70x85	41

HAREKETLİ TABAN RAFLI ÇALIŞMA TEZGAHLARI
MOVABLE WORKING TABLES WITH BOTTOM SHELF

EBAT (cm) DIM	KG
60x60x85	16
80x60x85	19
100x60x85	21
120x60x85	24
140x60x85	27
160x60x85	31
180x60x85	34
200x60x85	36
220x60x85	39
240x60x85	45
260x60x85	48
280x60x85	50

EBAT (cm) DIM	KG
60x70x85	16
80x70x85	21
100x70x85	23
120x70x85	27
140x70x85	32
160x70x85	35
180x70x85	38
200x70x85	41
220x70x85	44
240x70x85	51
260x70x85	53
280x70x85	56

HAREKETLİ TABAN VE ARA RAFLI ÇALIŞMA TEZGAHLARI
MOVABLE WORKING TABLES WITH BOTTOM AND MIDDLE SHELF

EBAT (cm) DIM	KG
60x60x85	18
80x60x85	23
100x60x85	26
120x60x85	29
140x60x85	34
160x60x85	39
180x60x85	42
200x60x85	46
220x60x85	49
240x60x85	56
260x60x85	59
280x60x85	63

EBAT (cm) DIM	KG
60x70x85	20
80x70x85	26
100x70x85	29
120x70x85	33
140x70x85	38
160x70x85	44
180x70x85	48
200x70x85	51
220x70x85	56
240x70x85	63
260x70x85	67
280x70x85	71

AÇIKLAMALAR \ DESCRIPTIONS

3 TARAFI KAPALI TABAN RAFLI ÇALIŞMA TEZGAHLARI
3 SIDES CLOSED WORKING TABLES WITH BOTTOM SHELF

EBAT (cm) DIM	KG
60x60x85	20
80x60x85	25
100x60x85	28
120x60x85	32
140x60x85	37
160x60x85	42
180x60x85	46
200x60x85	50
220x60x85	55
240x60x85	60
260x60x85	63
280x60x85	66

EBAT (cm) DIM	KG
60x70x85	22
80x70x85	27
100x70x85	31
120x70x85	35
140x70x85	41
160x70x85	47
180x70x85	51
200x70x85	56
220x70x85	60
240x70x85	66
260x70x85	69
280x70x85	73



3 TARAFI KAPALI TABAN VE ARA RAFLI ÇALIŞMA TEZGAHLARI
3 SIDES CLOSED WORKING TABLES WITH BOTTOM AND MIDDLE SHELF

EBAT (cm) DIM	KG
60x60x85	24
80x60x85	29
100x60x85	34
120x60x85	38
140x60x85	44
160x60x85	51
180x60x85	57
200x60x85	62
220x60x85	67
240x60x85	73
260x60x85	77
280x60x85	82

EBAT (cm) DIM	KG
60x70x85	28
80x70x85	33
100x70x85	38
120x70x85	43
140x70x85	50
160x70x85	58
180x70x85	63
200x70x85	69
220x70x85	75
240x70x85	81
260x70x85	86
280x70x85	91



AÇIKLAMALAR \ DESCRIPTIONS

-Paslanmaz çelik gövde.
-Kolay temizlenebilir.
-Ayarlanabilir rotli ayaklar.
-40x40 Profil ayaklar
-6 cm Sırtlı tabla

-Stainless steel body.
-Easy to clean.
-Adjustable ball joint feet.
-40x40 mm Profile
-6 cm Ridge on table

TR

ENG



DOLAPLI TABAN RAFLI ÇALIŞMA TEZGAHLARI
CABINET WORKING TABLES WITH BOTTOM SHELF

EBAT (cm) DIM	SÜRGÜ KAPI (KG)	ÇARPMA KAPI (KG)	EBAT (cm) DIM	SÜRGÜ KAPI (KG)	ÇARPMA KAPI (KG)
60x60x85	24	30	60x70x85	26	32
80x60x85	30	32	80x70x85	33	34
100x60x85	35	36	100x70x85	38	40
120x60x85	40	42	120x70x85	44	45
140x60x85	46	49	140x70x85	50	53
160x60x85	52	55	160x70x85	57	61
180x60x85	58	62	180x70x85	63	67
200x60x85	63	68	200x70x85	68	73
220x60x85	68	74	220x70x85	74	79
240x60x85	75	80	240x70x85	81	87
260x60x85	80	86	260x70x85	86	92
280x60x85	84	91	280x70x85	91	98

DOLAPLI TABAN VE ARA RAFLI ÇALIŞMA TEZGAHLARI
CABINET WORKING TABLES WITH BOTTOM AND MIDDLE SHELF

EBAT (cm) DIM	SÜRGÜ KAPI (KG)	ÇARPMA KAPI (KG)	EBAT (cm) DIM	SÜRGÜ KAPI (KG)	ÇARPMA KAPI (KG)
60x60x85	28	33	60x70x85	31	36
80x60x85	35	36	80x70x85	40	41
100x60x85	41	42	100x70x85	46	47
120x60x85	47	49	120x70x85	52	53
140x60x85	55	57	140x70x85	61	62
160x60x85	62	65	160x70x85	70	72
180x60x85	69	72	180x70x85	76	79
200x60x85	75	79	200x70x85	82	86
220x60x85	81	86	220x70x85	89	94
240x60x85	89	94	240x70x85	97	102
260x60x85	94	100	260x70x85	104	109
280x60x85	100	106	280x70x85	110	116

AÇIKLAMALAR \ DESCRIPTIONS

TR

-Paslanmaz çelik gövde.

-Kolay temizlenebilir.

-Ayarlanabilir rotül ayaklar.

-40x40 Profil ayaklar

-6 cm Sırtlı tabla

ENG

-Stainless steel body.

-Easy to clean.

-Adjustable ball joint feet.

-40x40 mm Profile

-6 cm Ridge on table

POLİETİLEN TABLALI ÇALIŞMA TEZGAHLARI
WORKING TABLES WITH POLYETHYLENE SHELF

EBAT (cm) DIM	KG	EBAT (cm) DIM	KG
60x60x85	13	60x70x85	14
80x60x85	14	80x70x85	15
100x60x85	15	100x70x85	16
120x60x85	16	120x70x85	17
140x60x85	17	140x70x85	18
160x60x85	18	160x70x85	19
180x60x85	19	180x70x85	20
200x60x85	21	200x70x85	22
220x60x85	22	220x70x85	23
240x60x85	23	240x70x85	24
260x60x85	24	260x70x85	25
280x60x85	25	280x70x85	26



POLİETİLEN TABLALI TABAN RAFLU ÇALIŞMA TEZGAHLARI
WORKING TABLES WITH BOTTOM SHELF WITH POLYETHYLENE SHELF

EBAT (cm) DIM	KG	EBAT (cm) DIM	KG
60x60x85	17	60x70x85	18
80x60x85	19	80x70x85	20
100x60x85	21	100x70x85	22
120x60x85	23	120x70x85	24
140x60x85	25	140x70x85	27
160x60x85	27	160x70x85	29
180x60x85	29	180x70x85	31
200x60x85	32	200x70x85	34
220x60x85	34	220x70x85	36
240x60x85	36	240x70x85	39
260x60x85	38	260x70x85	41
280x60x85	40	280x70x85	43



POLİETİLEN TABLALI TABAN VE ARA RAFLU ÇALIŞMA TEZGAHLARI
POLYETHYLENE SHELF WORKING TABLES WITH BOTTOM AND MIDDLE SHELF

EBAT (cm) DIM	KG	EBAT (cm) DIM	KG
60x60x85	20	60x70x85	22
80x60x85	23	80x70x85	25
100x60x85	26	100x70x85	28
120x60x85	29	120x70x85	31
140x60x85	32	140x70x85	35
160x60x85	35	160x70x85	38
180x60x85	39	180x70x85	42
200x60x85	43	200x70x85	45
220x60x85	46	220x70x85	48
240x60x85	49	240x70x85	52
260x60x85	52	260x70x85	56
280x60x85	55	280x70x85	60



AÇIKLAMALAR \ DESCRIPTIONS

-Paslanmaz çelik gövde.
-Kolay temizlenebilir.
-Ayarlanabilir rotül ayaklar.
-40x40 Profil ayaklar
-Polietilen ekstra ücretlendirilecektir.

-Stainless steel body.
-Easy to clean.
-Adjustable ball joint feet.
-40x40 mm Profile
-Polyethylene will be extra charged.

TR

ENG

Polietilen m³ Fiyatı;
3 €

NÖTRSET/POLİETİLEN ÇALIŞMA TEZGAHLARI

NOTRSET/POLYETHYLENE WORK TABLES

NÖTRSET
NOTRSET



Polietilen m³ Fiyatı;
3 €

POLİETİLEN TABLALI TABAN RAFLI DOLAPLI ÇALIŞMA TEZGAHLARI

BOTTOM SHELF AND CABINET WORKING TABLES WITH POLYETHYLENE SHELF

EBAT (cm) DIM	KG
60x60x85	17
80x60x85	19
100x60x85	21
120x60x85	23
140x60x85	27
160x60x85	31
180x60x85	34
200x60x85	37
220x60x85	40
240x60x85	44
260x60x85	46
280x60x85	48

EBAT (cm) DIM	KG
60x70x85	19
80x70x85	21
100x70x85	23
120x70x85	26
140x70x85	30
160x70x85	35
180x70x85	38
200x70x85	41
220x70x85	44
240x70x85	48
260x70x85	50
280x70x85	53

POLİETİLEN TABLALI TABAN VE ARA RAFLI DOLAPLI ÇALIŞMA TEZGAHLARI

BOTTOM, MIDDLE SHELF, CABINET WORKING TABLES WITH POLY.SHELF

EBAT (cm) DIM	KG
60x60x85	20
80x60x85	24
100x60x85	27
120x60x85	31
140x60x85	35
160x60x85	41
180x60x85	45
200x60x85	49
220x60x85	53
240x60x85	57
260x60x85	60
280x60x85	64

EBAT (cm) DIM	KG
60x70x85	22
80x70x85	27
100x70x85	30
120x70x85	34
140x70x85	39
160x70x85	46
180x70x85	50
200x70x85	54
220x70x85	58
240x70x85	63
260x70x85	67
280x70x85	70

POLİETİLEN TABLALI TABAN RAFLI, DOLAPLI, KAPILI ÇAL. TEZGAHLARI

BOTTOM SHELF, CABINET, DOOR WORKING TABLES WITH POLY.SHELF

EBAT (cm) DIM	KG
60x60x85	20
80x60x85	25
100x60x85	28
120x60x85	32
140x60x85	37
160x60x85	41
180x60x85	46
200x60x85	50
220x60x85	54
240x60x85	59
260x60x85	62
280x60x85	66

EBAT (cm) DIM	KG
60x70x85	21
80x70x85	27
100x70x85	31
120x70x85	34
140x70x85	39
160x70x85	45
180x70x85	49
200x70x85	53
220x70x85	57
240x70x85	63
260x70x85	67
280x70x85	70

POLİETİLEN TABLALI TABAN VE ARA RAFLI DOLAPLI, KAPILI ÇAL. TEZGAHLARI

BOTTOM, MIDDLE SHELF, CABINET, DOOR WORKING TABLES WITH POLY.SHELF

EBAT (cm) DIM	KG
60x60x85	25
80x60x85	30
100x60x85	35
120x60x85	39
140x60x85	45
160x60x85	51
180x60x85	57
200x60x85	62
220x60x85	67
240x60x85	73
260x60x85	77
280x60x85	82

EBAT (cm) DIM	KG
60x70x85	26
80x70x85	33
100x70x85	38
120x70x85	43
140x70x85	50
160x70x85	57
180x70x85	62
200x70x85	67
220x70x85	73
240x70x85	79
260x70x85	84
280x70x85	89

AÇIKLAMALAR \ DESCRIPTIONS

- Paslanmaz çelik gövde.
- Kolay temizlenebilir.
- Ayarlanabilir rotol ayaklar.
- 40x40 Profil ayaklar.
- Kullanıma göre renk tercihi yapılabilir.

- Stainless steel body.
- Easy to clean.
- Adjustable ball joint feet.
- 40x40 mm Profile.
- Color preference can be made according to usage.

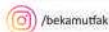

/beka.mutfak

/bekamutfak

www.bekamutfak.com.tr

DOLAPLI, BLOK ÇEKMECELİ TABAN RAFLI ÇALIŞMA TEZGAHLARI
CABINET WORKING TABLES WITH BLOCK DRAWER AND BOTTOM SHELF

EBAT (cm) DIM	SÜRGÜ KAPI (KG)	ÇARPMA KAPI (KG)	EBAT (cm) DIM	SÜRGÜ KAPI (KG)	ÇARPMA KAPI (KG)
60x60x85	39	45	60x70x85	41	47
80x60x85	45	47	80x70x85	48	49
100x60x85	50	51	100x70x85	53	55
120x60x85	55	57	120x70x85	59	60
140x60x85	61	64	140x70x85	65	68
160x60x85	67	70	160x70x85	72	76
180x60x85	73	77	180x70x85	78	82
200x60x85	78	83	200x70x85	83	88
220x60x85	83	89	220x70x85	89	94
240x60x85	90	95	240x70x85	96	102
260x60x85	95	101	260x70x85	101	107
280x60x85	99	106	280x70x85	106	113



DOLAPLI, BLOK ÇEKMECELİ TABAN VE ARA RAFLI ÇALIŞMA TEZGAHLARI
CABINET WORKING TABLES WITH BLOCK DRAWER & BOTTOM AND M. SHELF

EBAT (cm) DIM	SÜRGÜ KAPI (KG)	ÇARPMA KAPI (KG)	EBAT (cm) DIM	SÜRGÜ KAPI (KG)	ÇARPMA KAPI (KG)
60x60x85	43	48	60x70x85	46	51
80x60x85	50	51	80x70x85	55	56
100x60x85	56	57	100x70x85	61	62
120x60x85	62	64	120x70x85	67	68
140x60x85	70	72	140x70x85	76	77
160x60x85	77	80	160x70x85	85	87
180x60x85	84	87	180x70x85	91	94
200x60x85	90	94	200x70x85	97	101
220x60x85	96	101	220x70x85	104	109
240x60x85	104	109	240x70x85	112	117
260x60x85	109	115	260x70x85	119	124
280x60x85	115	121	280x70x85	125	129



AÇIKLAMALAR \ DESCRIPTIONS

-Paslanmaz çelik gövde.
-Kolay temizlenebilir.
-Ayarlanabilir rotli ayaklar.
-40x40 Profil ayaklar
-6 cm Sırtlı tabla

-Stainless steel body.
-Easy to clean.
-Adjustable ball joint feet.
-40x40 mm Profile
-6 cm Ridge on table

TR

ENG



NÖTRSET / DEVRİLİR EKMEKLİKLİ & TEK ÇEKMECELİ ÇALIŞMA TEZGAHLARI

NOTRSET/ TILTING BREAD UNIT & 1 DRAWER WORK TABLES

NÖTRSET
NOTRSET



DOLAPLI, TEK ÇEKMECELİ ÇALIŞMA TEZGAHLARI

CABINET WORKING TABLES WITH ONE DRAWER

EBAT (cm) DIM	KG
60x60x85	30
80x60x85	36
100x60x85	41
120x60x85	46
140x60x85	52
160x60x85	58
180x60x85	64
200x60x85	69
220x60x85	74
240x60x85	81
260x60x85	86
280x60x85	90

EBAT (cm) DIM	KG
60x70x85	32
80x70x85	39
100x70x85	44
120x70x85	50
140x70x85	56
160x70x85	63
180x70x85	69
200x70x85	74
220x70x85	80
240x70x85	87
260x70x85	94
280x70x85	97

DOLAPLI, DEVRİLİR EKMEKLİKLİ ÇALIŞMA TEZGAHLARI

CABINET WORKING TABLES WITH TILTING BREAD UNIT



EBAT (cm) DIM	KG
60x60x85	29
80x60x85	35
100x60x85	40
120x60x85	45
140x60x85	51
160x60x85	57
180x60x85	63
200x60x85	68
220x60x85	73
240x60x85	80
260x60x85	85
280x60x85	89

EBAT (cm) DIM	KG
60x70x85	31
80x70x85	38
100x70x85	43
120x70x85	49
140x70x85	55
160x70x85	62
180x70x85	68
200x70x85	73
220x70x85	79
240x70x85	86
260x70x85	93
280x70x85	96

AÇIKLAMALAR \ DESCRIPTIONS

TR

-Paslanmaz çelik gövde.

-Kolay temizlenebilir.

-Ayarlanabilir rotül ayaklar.

-40x40 Profil ayaklar

-6 cm Sırtlı tabla

ENG

-Stainless steel body.

-Easy to clean.

-Adjustable ball joint feet.

-40x40 mm Profile

-6 cm Ridge on table

TEK EVYELİ ÇALIŞMA TEZGAHLARI
SINGLE SINK WORKING TABLES

EBAT (cm) DIM	KG	EBAT (cm) DIM	KG
60x60x85	17	60x70x85	19
80x60x85	19	80x70x85	21
100x60x85	21	100x70x85	23
120x60x85	23	120x70x85	25
140x60x85	25	140x70x85	27
160x60x85	28	160x70x85	30
180x60x85	30	180x70x85	33
200x60x85	31	200x70x85	35
220x60x85	33	220x70x85	38
240x60x85	39	240x70x85	43
260x60x85	41	260x70x85	45
280x60x85	43	280x70x85	47



TEK EVYELİ TABAN RAFLI ÇALIŞMA TEZGAHLARI
SINGLE SINK WORKING TABLES WITH BOTTOM SHELF

EBAT (cm) DIM	KG	EBAT (cm) DIM	KG
60x60x85	20	60x70x85	22
80x60x85	22	80x70x85	24
100x60x85	25	100x70x85	27
120x60x85	28	120x70x85	31
140x60x85	32	140x70x85	36
160x60x85	37	160x70x85	41
180x60x85	40	180x70x85	44
200x60x85	43	200x70x85	48
220x60x85	47	220x70x85	52
240x60x85	53	240x70x85	59
260x60x85	56	260x70x85	63
280x60x85	59	280x70x85	66



AÇIKLAMALAR \ DESCRIPTIONS

TR

ENG

-Su taşını önleyici indirimli üst tabla
-Paslanmaz çelik gövde.
-Kolay temizlenebilir.
-Ayarlanabilir rotül ayaklar.
-40x40 Profil ayaklar
-6 cm Sırtlı tabla
-Evyeler ekstra ücretlendirilecektir.

-Water holder top table
-Stainless steel body.
-Easy to clean.
-Adjustable ball joint feet.
-40x40 mm Profile
-6 cm Ridge on table
-Sink will be extra charged.

EVYELİ TEZGAHLAR STANDART OLARAK BATARYA (MUSLUK) DELİKLİ GELMEKTEDİR. EĞER BATARYANIZ DUVARA MONTE İSE SİPARİŞ ESNASINDA BUNU BELİRTİNİZ.

SINK BENCHES ARE STANDARD WITH TAP HOLES. IF YOUR TAP IF WALL MOUNTED, YOU MUST PROVIDE THIS DURING THE ORDER

Evye Fiyatları
(Sink Prices);

40x40x25	60 €
40x50x25	70 €
50x50x25	80 €

NÖTRSET / ÇİFT EVYELİ ÇALIŞMA TEZGAHLARI

NOTRSET / DOUBLE SINK WORK TABLES

NÖTRSET
NOTRSET



ÇİFT EVYELİ ÇALIŞMA TEZGAHLARI

DOUBLE SINK WORKING TABLES

EBAT (cm) DIM	KG	EBAT (cm) DIM	KG
120x60x85	23	120x70x85	25
140x60x85	25	140x70x85	27
160x60x85	28	160x70x85	30
180x60x85	30	180x70x85	33
200x60x85	31	200x70x85	35
220x60x85	33	220x70x85	38
240x60x85	39	240x70x85	43
260x60x85	41	260x70x85	45
280x60x85	43	280x70x85	47

ÇİFT EVYELİ TABAN RAFLI ÇALIŞMA TEZGAHLARI

DOUBLE SINK WORKING TABLES WITH BOTTOM SHELF

EBAT (cm) DIM	KG	EBAT (cm) DIM	KG
120x60x85	28	120x70x85	31
140x60x85	32	140x70x85	36
160x60x85	37	160x70x85	41
180x60x85	40	180x70x85	44
200x60x85	43	200x70x85	48
220x60x85	47	220x70x85	52
240x60x85	53	240x70x85	59
260x60x85	56	260x70x85	63
280x60x85	59	280x70x85	66

AÇIKLAMALAR \ DESCRIPTIONS

TR

-Su taşıntı önleyici indirimli üst tabla
-Paslanmaz çelik gövde.
-Kolay temizlenebilir.
-Ayarlanabilir rotli ayaklar.
-40x40 Profil ayaklar
-6 cm Sırtlı tabla

ENG

-Water holder top table
-Stainless steel body.
-Easy to clean.
-Adjustable ball joint feet.
-40x40 mm Profile
-6 cm Ridge on table



Evye Fiyatları (Sink Prices);

40x40x25	60 €
40x50x25	70 €
50x50x25	80 €



EVYELİ TEZGAHLAR STANDART OLARAK BATARYA (MUSLUK) DELİKLİ GELMEKTEDİR. EĞER BATARYANIZ DUVARA MONTE İSE SİPARİŞ ESNASINDA BUNU BELİRTİNİZ

SINK BENCHES ARE STANDARD WITH TAP HOLES. IF YOUR TAP IF WALL MOUNTED, YOU MUST PROVIDE THIS DURING THE ORDER

3 TARAFI KAPALI TEK EVYELİ ÇALIŞMA TEZGAHLARI
3 SIDES CLOSED SINGLE SINK WORKING TABLES

EBAT (cm) DIM	KG	EBAT (cm) DIM	KG
60x60x85	23	60x70x85	26
80x60x85	26	80x70x85	29
100x60x85	30	100x70x85	33
120x60x85	33	120x70x85	37
140x60x85	39	140x70x85	43
160x60x85	44	160x70x85	50
180x60x85	49	180x70x85	54
200x60x85	53	200x70x85	59
220x60x85	58	220x70x85	64
240x60x85	63	240x70x85	69
260x60x85	67	260x70x85	74
280x60x85	71	280x70x85	78

3 TARAFI KAPALI ÇİFT EVYELİ ÇALIŞMA TEZGAHLARI
3 SIDES CLOSED DOUBLE SINK WORKING TABLES

EBAT (cm) DIM	KG	EBAT (cm) DIM	KG
120x60x85	33	120x70x85	37
140x60x85	39	140x70x85	43
160x60x85	44	160x70x85	50
180x60x85	49	180x70x85	54
200x60x85	53	200x70x85	59
220x60x85	58	220x70x85	64
240x60x85	63	240x70x85	69
260x60x85	67	260x70x85	74
280x60x85	71	280x70x85	78

AÇIKLAMALAR \ DESCRIPTIONS

-Su taşıntı önleyici indirimli üst tabla
-Paslanmaz çelik gövde.
-Kolay temizlenebilir.
-Ayarlanabilir rotol ayaklar.
-40x40 Profil ayaklar
-6 cm Sırtlı tabla

-Water holder top table
-Stainless steel body.
-Easy to clean.
-Adjustable ball joint feet.
-40x40 mm Profile
-6 cm Ridge on table

EVYELİ TEZGAHLAR STANDART OLARAK BATARYA (MUSLUK) DELİKLİ GELMEKTEDİR. EĞER BATARYANIZ DUVARA MONTE İSE SİPARİŞ ESNASINDA BUNU BELİRTİNİZ

SINK BENCHES ARE STANDARD WITH TAP HOLES. IF YOUR TAP IF WALL MOUNTED, YOU MUST PROVIDE THIS DURING THE ORDER

KAPALI/DOLAPLI EVYELERİN ARKA KISMINDA EN AZ 50x50 cm TESİSAT BOŞLUĞU BIRAKILMAKTADIR.
THERE IS INSTALLATION SPACE BEHIND THE SINK 50x50 cm



TR

ENG

Evye Fiyatları
(Sink Prices);

40x40x25 60 €

40x50x25 70 €

50x50x25 80 €

NÖTRSET / DOLAPLI EVYELİ ÇALIŞMA TEZGAHLARI

NOTRSET / CABINET SINK WORK TABLES

NÖTRSET
NOTRSET



DOLAPLI TEK EVYELİ ÇALIŞMA TEZGAHLARI

CABINET SINGLE SINK WORKING TABLES

EBAT (cm) DIM	KG	EBAT (cm) DIM	KG
60x60x85	28	60x70x85	30
80x60x85	31	80x70x85	33
100x60x85	35	100x70x85	38
120x60x85	40	120x70x85	44
140x60x85	46	140x70x85	50
160x60x85	52	160x70x85	57
180x60x85	58	180x70x85	63
200x60x85	63	200x70x85	68
220x60x85	68	220x70x85	74
240x60x85	75	240x70x85	81
260x60x85	80	260x70x85	86
280x60x85	84	280x70x85	91

DOLAPLI ÇİFT EVYELİ ÇALIŞMA TEZGAHLARI

CABINET DOUBLE SINK WORKING TABLES

EBAT (cm) DIM	KG	EBAT (cm) DIM	KG
120x60x85	40	120x70x85	44
140x60x85	46	140x70x85	50
160x60x85	52	160x70x85	57
180x60x85	58	180x70x85	63
200x60x85	63	200x70x85	68
220x60x85	68	220x70x85	74
240x60x85	75	240x70x85	81
260x60x85	80	260x70x85	86
280x60x85	84	280x70x85	91

AÇIKLAMALAR \ DESCRIPTIONS

TR

-Su taşını önleyici indirimli üst tabla
-Paslanmaz çelik gövde.
-Kolay temizlenebilir.
-Ayarlanabilir rotol ayaklar.
-40x40 Profil ayaklar
-6 cm Sırtlı tabla

ENG

-Water holder top table
-Stainless steel body.
-Easy to clean.
-Adjustable ball joint feet.
-40x40 mm Profile
-6 cm Ridge on table

Evye Fiyatları (Sink Prices);

40x40x25	60 €
40x50x25	70 €
50x50x25	80 €

KAPALI/DOLAPLI EVYELERİN ARKA KISMINDA EN AZ 50x50 cm TESİSAT BOŞLUĞU BIRAKILMAKTADIR.

THERE IS INSTALLATION SPACE BEHIND THE SINK 50x50 cm

EVYELİ TEZGAHLAR STANDART OLARAK BATARYA (MUSLUK) DELİKLİ GELMEKTEDİR. EĞER BATARYANIZ DUVARA MONTE İSE SİPARİŞ ESNASINDA BUNU BELİRTİNİZ

SINK BENCHES ARE STANDARD WITH TAP HOLES, IF YOUR TAP IS WALL MOUNTED, YOU MUST PROVIDE THIS DURING THE ORDER

NÖTRSET / BULAŞIK MAKİNESİ GİRİŞ - ÇIKIŞ TEZGAHLARI

NOTRSET/ DISHWASHING MACHINE COUNTERS (ENTRANCE AND EXIT)

NÖTRSET
NOTRSET

RAFSIZ VE RAFLI BYM GİRİŞ TEZGAHLARI NO SHELF AND BOTTOM SHELF BYM ENTRANCE TABLES

EBAT (cm) DIM	RAFSIZ KG	EBAT (cm) DIM	RAFLI KG
60x60x85	17	60x70x85	20
80x60x85	19	80x70x85	22
100x60x85	21	100x70x85	25
120x60x85	23	120x70x85	28
140x60x85	25	140x70x85	33
160x60x85	28	160x70x85	38
180x60x85	30	180x70x85	40
200x60x85	32	200x70x85	43
220x60x85	34	220x70x85	47
240x60x85	41	240x70x85	54
260x60x85	43	260x70x85	57
280x60x85	44	280x70x85	60

RAFSIZ VE RAFLI BYM ÇIKIŞ TEZGAHLARI NO SHELF AND BOTTOM SHELF BYM EXIT TABLES

EBAT (cm) DIM	RAFSIZ KG	EBAT (cm) DIM	RAFLI KG
60x60x85	17	60x70x85	20
80x60x85	19	80x70x85	22
100x60x85	21	100x70x85	25
120x60x85	23	120x70x85	28
140x60x85	25	140x70x85	33
160x60x85	28	160x70x85	38
180x60x85	30	180x70x85	40
200x60x85	32	200x70x85	43
220x60x85	34	220x70x85	47
240x60x85	41	240x70x85	54
260x60x85	43	260x70x85	57
280x60x85	44	280x70x85	60

AÇIKLAMALAR \ DESCRIPTIONS

TR

ENG

-Paslanmaz çelik gövde.
-Kolay temizlenebilir.
-Ayarlanabilir rotül ayaklar.
-6 cm sırt.
-Evyeler extra ücretlendirilecektir.

-Stainless steel body.
-Easy to clean.
-Adjustable ball joint feet.
-6 cm tread.
-Sinks will be extra charged.



SİPARİŞ VERİRKEN BULAŞIK MAKİNESİNİN DURUMUNA GÖRE GİRİŞ-ÇIKIŞ TEZGAHININ YÖNÜNÜ BELİRTMENİZ GEREKMEKTEDİR. BAKINIZ (PLAN 01 / PLAN 02)

SPECIFY THE IN-OUT COUNTER DIRECTION WHEN ORDERING LEFT OR RIGHT

Evye Fiyatları
(Sink Prices);

40x40x25	60 €
40x50x25	70 €
50x50x25	80 €

PLAN 01

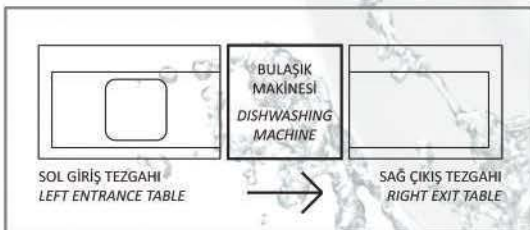

PLAN 02

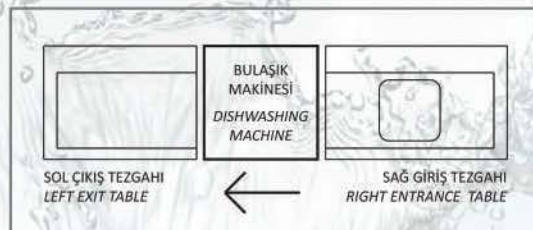

BEKA
ENDÜSTRİYEL MUTFAK

NÖTRSET / SEBZE YIKAMA TEZGAHI

NOTRSET / VEGETABLES WASHING COUNTERS



SEBZE YIKAMA TEZGAHLARI VEGETABLES WASHING COUNTERS

EBAT (cm) DIM	KG	EBAT (cm) DIM	KG	EBAT (cm) DIM	KG
80x60x85	27	80x70x85	30	80x80x85	33
100x60x85	31	100x70x85	33	100x80x85	35
120x60x85	34	120x70x85	37	120x80x85	40
140x60x85	38	140x70x85	41	140x80x85	44
160x60x85	42	160x70x85	45	160x80x85	48
180x60x85	45	180x70x85	49	180x80x85	53
200x60x85	51	200x70x85	56	200x80x85	61
220x60x85	55	220x70x85	60	220x80x85	65
240x60x85	59	240x70x85	64	240x80x85	69

AÇIKLAMALAR \ DESCRIPTIONS

TR

-Paslanmaz çelik gövde.
-Havuz içinde portatif delikli sac
-Kolay temizlenebilir.
-Ayarlanabilir rotol ayaklar.
-6 cm sırt.

ENG

-Stainless steel body.
-Portable perforated plate in pool
-Easy to clean.
-Adjustable ball joint feet.
-6 cm tread.



EVYELİ TEZGAHLAR STANDART OLARAK BATARYA (MUSLUK) DELİKLİ GELMEKTEDİR. EĞER BATARYANIZ DUVARA MONTE İSE SİPARİŞ ESNASINDA BUNU BELİRTİNİZ.

SINK BENCHES ARE STANDARD WITH TAP HOLES. IF YOUR TAP IF WALL MOUNTED, YOU MUST PROVIDE THIS DURING THE ORDER



160 CM'NİN ÜSTÜNDEKİ SEBZE YIKAMA TEZGAHLARI ÇİFT HAVUZLU OLARAK GELMEKTEDİR.
COUNTERS OVER 160 CM ARE WITH DOUBLE POOL.



KAZAN YIKAMA TEZGAHLARI
BOILER WASHING TABLES

EBAT (cm) DIM	KG	EBAT (cm) DIM	KG	EBAT (cm) DIM	KG	EBAT (cm) DIM	KG
80x80x85	33	80x90x85	36	80x100x85	38	80x110x85	41
100x80x85	38	100x90x85	40	100x100x85	43	100x110x85	46
120x80x85	42	120x90x85	45	120x100x85	48	120x110x85	51
140x80x85	47	140x90x85	50	140x100x85	53	140x110x85	56
160x80x85	51	160x90x85	55	160x100x85	58	160x110x85	62
180x80x85	55	180x90x85	59	180x100x85	63	180x110x85	67
200x80x85	62	200x90x85	66	200x100x85	71	200x110x85	75
220x80x85	67	220x90x85	71	220x100x85	76	220x110x85	80
240x80x85	71	240x90x85	76	240x100x85	81	240x110x85	85
260x80x85	76	260x90x85	81	260x100x85	86	260x110x85	91
280x80x85	80	280x90x85	85	280x100x85	91	280x110x85	96

AÇIKLAMALAR \ DESCRIPTIONS

TR

- Paslanmaz çelik gövde.
- Kolay temizlenebilir.
- Havuz içinde portatif ızgara.
- Ayarlanabilir rotül ayaklar.
- 36 cm sırt

- Stainless steel body.
- Easy to clean
- Portable perforated grill in pool.
- Adjustable ball joint feet.
- 36 cm tread

ENG



EYELİ TEZGAHLARDA STANDART OLARAK BATARYA (MUSLUK) DELİKLİ GELMEKTEDİR. EĞER BATARYANIZ DUVARA MONTE İŞE SİPARİŞ ESNASINDA BUNU BELİRTİNİZ.

SINK BENCHES ARE STANDART WITH TAP HOLES. IF YOUR TAP IS WALL MOUNTED, YOU MUST PROVIDE THIS DURING THE ORDER.

NÖTR ÜNİTELER/ 3 KATLI İSTİF RAFLARI
NEUTRAL UNITS/ SHELF WITH 3 FLOOR3 KATLI İSTİF RAFLARI
THREE FLOORS PALLETES

EBAT (cm) DIM	KG
100x40x153	24
120x40x153	27
140x40x153	31
160x40x153	34
180x40x153	38
200x40x153	40
220x40x153	44
240x40x153	51
260x40x153	53
280x40x153	56

EBAT (cm) DIM	KG
100x50x153	28
120x50x153	31
140x50x153	36
160x50x153	39
180x50x153	44
200x50x153	47
220x50x153	52
240x50x153	59
260x50x153	62
280x50x153	65

EBAT (cm) DIM	KG
100x60x153	31
120x60x153	35
140x60x153	41
160x60x153	45
180x60x153	50
200x60x153	54
220x60x153	60
240x60x153	67
260x60x153	71
280x60x153	75

EBAT (cm) DIM	KG
100x70x153	35
120x70x153	39
140x70x153	46
160x70x153	50
180x70x153	57
200x70x153	61
220x70x153	68
240x70x153	76
260x70x153	80
280x70x153	84

AÇIKLAMALAR \ DESCRIPTIONS

- TR** -Paslanmaz çelik gövde.
-Kolay temizlenebilir.
ENG -Ayarlanabilir rotül ayaklar.
-Delikli tablalar.

- Stainless steel body.
-Easy to clean.
-Adjustable ball joint feet.
-Perforated shelves.



430 KALİTE ÜRÜNLERİN SOĞUK ODA VE ISLAK HACİMLİ YERLERDE KULLANIMI UYGUN DEĞİLDİR.
THE 430 QUALITY PRODUCTS ARE NOT SUITABLE FOR USE IN COLD ROOMS AND WET AREAS.

NÖTR ÜNİTELER-DEPOLAMA / 3 KATLI İSTİF RAFLARI NEUTRAL UNITS-STORAGE / SHELF WITH 4 FLOOR



3 KATLI DELİKLİ İSTİF RAFLARI PERFORED SHELF WITH 3 FLOOR

EBAT (cm) DIM	KG
100x40x153	24
120x40x153	27
140x40x153	31
160x40x153	34
180x40x153	38
200x40x153	40
220x40x153	44
240x40x153	51
260x40x153	53
280x40x153	56

EBAT (cm) DIM	KG
100x50x153	28
120x50x153	31
140x50x153	36
160x50x153	39
180x50x153	44
200x50x153	47
220x50x153	52
240x50x153	59
260x50x153	62
280x50x153	65

EBAT (cm) DIM	KG
100x60x153	31
120x60x153	35
140x60x153	41
160x60x153	45
180x60x153	50
200x60x153	54
220x60x153	60
240x60x153	67
260x60x153	71
280x60x153	75

EBAT (cm) DIM	KG
100x70x153	35
120x70x153	39
140x70x153	46
160x70x153	50
180x70x153	57
200x70x153	61
220x70x153	68
240x70x153	76
260x70x153	80
280x70x153	84

AÇIKLAMALAR \ DESCRIPTIONS

- TR** -Paslanmaz çelik gövde.
-Kolay temizlenebilir.
ENG -Ayarlanabilir rotli ayaklar.
-Delikli tablalar.

- Stainless steel body.
-Easy to clean.
-Adjustable ball joint feet.
-Perfored shelves.



430 KALİTE ÜRÜNLERİN SOĞUK ODA VE ISLAK HACİMLİ YERLERDE KULLANIMI UYGUN DEĞİLDİR.
THE 430 QUALITY PRODUCTS ARE NOT SUITABLE FOR USE IN COLD ROOMS AND WET AREAS.

NÖTR ÜNİTELER-DEPOLAMA / 4 KATLI İSTİF RAFLARI
NEUTRAL UNITS-STORAGE / PERFORED SHELF WITH 4 FLOOR4 KATLI İSTİF RAFLARI
FOUR FLOORS PALLETS

EBAT (cm) DIM	KG
100x40x153	30
120x40x153	33
140x40x153	39
160x40x153	42
180x40x153	48
200x40x153	51
220x40x153	56
240x40x153	64
260x40x153	67
280x40x153	71

EBAT (cm) DIM	KG
100x50x153	34
120x50x153	39
140x50x153	45
160x50x153	49
180x50x153	56
200x50x153	60
220x50x153	67
240x50x153	75
260x50x153	79
280x50x153	83

EBAT (cm) DIM	KG
100x60x153	39
120x60x153	44
140x60x153	52
160x60x153	57
180x60x153	65
200x60x153	70
220x60x153	77
240x60x153	86
260x60x153	91
280x60x153	96

EBAT (cm) DIM	KG
100x70x153	44
120x70x153	49
140x70x153	58
160x70x153	64
180x70x153	73
200x70x153	79
220x70x153	88
240x70x153	97
260x70x153	103
280x70x153	109

AÇIKLAMALAR \ DESCRIPTIONS

- TR -Paslanmaz çelik gövde.
-Kolay temizlenebilir.
ENG -Ayarlanabilir rotül ayaklar.
-Delikli tablalar.

- Stainless steel body.
-Easy to clean.
-Adjustable ball joint feet.
-Perforated shelves.



430 KALİTE ÜRÜNLERİN SOĞUK ODA VE ISLAK HACİMLİ YERLERDE KULLANIMI UYGUN DEĞİLDİR.
THE 430 QUALITY PRODUCTS ARE NOT SUITABLE FOR USE IN COLD ROOMS AND WET AREAS.



4 KATLI İSTİF RAFLARI
FOUR FLOORS PALLETS

EBAT (cm) DIM	KG
100x40x153	30
120x40x153	33
140x40x153	39
160x40x153	42
180x40x153	48
200x40x153	51
220x40x153	56
240x40x153	64
260x40x153	67
280x40x153	71

EBAT (cm) DIM	KG
100x50x153	34
120x50x153	39
140x50x153	45
160x50x153	49
180x50x153	56
200x50x153	60
220x50x153	67
240x50x153	75
260x50x153	79
280x50x153	83

EBAT (cm) DIM	KG
100x60x153	39
120x60x153	44
140x60x153	52
160x60x153	57
180x60x153	65
200x60x153	70
220x60x153	77
240x60x153	86
260x60x153	91
280x60x153	96

EBAT (cm) DIM	KG
100x70x153	44
120x70x153	49
140x70x153	58
160x70x153	64
180x70x153	73
200x70x153	79
220x70x153	88
240x70x153	97
260x70x153	103
280x70x153	109

AÇIKLAMALAR \ DESCRIPTIONS

- TR** -Paslanmaz çelik gövde.
-Kolay temizlenebilir.
ENG -Ayarlanabilir rotül ayaklar.
-Delikli tablalar.

- Stainless steel body.
-Easy to clean.
-Adjustable ball joint feet.
-Perforated shelves.



430 KALİTE ÜRÜNLERİN SOĞUK ODA VE ISLAK HACİMLİ YERLERDE KULLANIMI UYGUN DEĞİLDİR.
THE 430 QUALITY PRODUCTS ARE NOT SUITABLE FOR USE IN COLD ROOMS AND WET AREAS.

NÖTR ÜNİTELER-DEPOLAMA / DUVAR DOLAPLARI
NEUTRAL UNITS-STORAGE / WALL CABINETSKAPILI / KAPISIZ DUVAR DOLAPLARI
WITH DOOR / WITHOUT DOOR WALL CABINETS

EBAT (cm) DIM	KG
80x30x60	14
100x30x60	16
120x30x60	18
140x30x60	20
160x30x60	23
180x30x60	25
200x30x60	27
220x30x60	30
240x30x60	32
260x30x60	34

EBAT (cm) DIM	KG
80x40x60	15
100x40x60	17
120x40x60	20
140x40x60	22
160x40x60	25
180x40x60	27
200x40x60	30
220x40x60	32
240x40x60	34
260x40x60	37

EBAT (cm) DIM	KG
80x30x60	20
100x30x60	23
120x30x60	27
140x30x60	31
160x30x60	35
180x30x60	39
200x30x60	43
220x30x60	46
240x30x60	50
260x30x60	54

EBAT (cm) DIM	KG
80x40x60	21
100x40x60	25
120x40x60	29
140x40x60	33
160x40x60	37
180x40x60	41
200x40x60	45
220x40x60	49
240x40x60	53
260x40x60	57

AÇIKLAMALAR \ DESCRIPTIONS

TR -Paslanmaz çelik gövde.
-Kolay temizlenebilir.
ENG -Duvara monte.

-Stainless steel body.
-Easy to clean.
-Wall mounted.



FİYATLARIMIZA MONTAJ DAHİL DEĞİLDİR. / ASSEMBLY IS NOT INCLUDED IN OUR PRICES.



TEK KATLI / ÇİFT KATLI DUVAR RAFLARI
SINGLE FLOOR / DOUBLE FLOOR WALL SHELVES

EBAT (cm) DIM	KG
80x30x4	5
100x30x4	5,5
120x30x4	6
140x30x4	6,5
160x30x4	7
180x30x4	7,5
200x30x4	8,5
220x30x4	9
240x30x4	9,5
260x30x4	10

EBAT (cm) DIM	KG
80x40x4	5,5
100x40x4	6
120x40x4	7
140x40x4	7,5
160x40x4	8
180x40x4	9
200x40x4	9,5
220x40x4	10,5
240x40x4	11
260x40x4	12

EBAT (cm) DIM	KG
80x30x40	10
100x30x40	11
120x30x40	12
140x30x40	13
160x30x40	14
180x30x40	15
200x30x40	17
220x30x40	18
240x30x40	19
260x30x40	20

EBAT (cm) DIM	KG
80x40x40	11
100x40x40	12
120x40x40	14
140x40x40	15
160x40x40	16
180x40x40	18
200x40x40	19
220x40x40	21
240x40x40	22
260x40x40	24

AÇIKLAMALAR \ DESCRIPTIONS

TR

-Paslanmaz çelik gövde.

-Stainless steel body.

ENG

-Kolay temizlenebilir.

-Easy to clean.



FIYATLARIMIZA MONTAJ DAHİL DEĞİLDİR. / ASSEMBLY, IS NOT INCLUDED IN OUR PRICES.



FY383703 40x90x160

TEKLİ TEPŞİ TAŞIMA ARABASI (34x84)

24 KG

TR

SINGLE TRAY CARRYING TROLLEY

Tepşi taşıma arabası 20 sıralı olup, ray aralıkları 7 cm'dir. Tepşi taşıma arabası, tepşilerin düşmemesi için arkada sabit, önde portatif kilitli çubukla desteklenmiştir. Böylece tepşileri taşıırken ani hareketlerde tepşiler düşmez.
2 Frenli 2 frensiz 360° tekerlek istemi

ENG

Tray trolley with 20 floors and floor ranges 7 cm
Tray trolley with front and behind stopper for tray not fall
2 Stopper 2 not stopper 360° wheels



-Tekerler ayrıca ücretlendirilecektir.
-Stoppers will be extra charged.



FY383753 85x90x160

ÇİFTLİ TEPŞİ TAŞIMA ARABASI (34x84)

42 KG

TR

DOUBLE TRAY CARRYING TROLLEY

Tepşi taşıma arabası 20+20 sıralı olup, ray aralıkları 7 cm'dir. Tepşi taşıma arabası, tepşilerin düşmemesi için arkada sabit, önde portatif kilitli çubukla desteklenmiştir. Böylece tepşileri taşıırken ani hareketlerde tepşiler düşmez.
2 Frenli 2 frensiz 360° tekerlek istemi

ENG

Tray trolley with 20+20 floors and floor ranges 7 cm
Tray trolley with front and behind stopper for tray not fall
2 Stopper 2 not stopper 360° wheels

1 Takım Tekerlek;



20 €



FY353754 60x70x160

TEKLİ TEPŞİ TAŞIMA ARABASI (GN 2/1)

16 KG

TR

SINGLE TRAY CARRYING TROLLEY

Tepşi taşıma arabası 10 sıralı olup, ray aralıkları 16 cm'dir. Tepşi taşıma arabası, tepşilerin düşmemesi için arkada sabit, önde portatif kilitli çubukla desteklenmiştir. Böylece tepşileri taşıırken ani hareketlerde tepşiler düşmez.
Bu araba ile ; GN2/1x150mm- 10 AD. / GN1/1x150mm- 20 AD. taşıyabilirsiniz.
2 Frenli 2 frensiz 360° tekerlek sistemi

ENG

Tray trolley with 10 floors and floor ranges 16 cm
Tray trolley with front and behind stopper for tray not fall
You can carry with trolley ; GN2/1x150mm- 10 pcs. / GN1/1x150mm- 20 pcs.
2 Stopper 2 not stopper 360° wheels



FY353755 55x55x160

BASKET TAŞIMA ARABASI (50x50)

17 KG

TR

DISHWASHING TRAY CARRYING TROLLEY

Tepşi taşıma arabası 12 sıralı olup, ray aralıkları 12 cm'dir. Tepşi taşıma arabası, tepşilerin düşmemesi için arkada sabit, önde portatif kilitli çubukla desteklenmiştir. Böylece tepşileri taşıırken ani hareketlerde tepşiler düşmez.
2 Frenli 2 frensiz 360° tekerlek sistemi

ENG

Tray trolley with 12 floors and floor ranges 12 cm
Tray trolley with front and behind stopper for tray not fall
2 Stopper 2 not stopper 360° wheels

FY353701 40x55x160

TEKLİ TEPŞİ TAŞIMA ARABASI (37x53)

19 KG

SINGLE TRAY CARRYING TROLLEY

TR Tepsi taşıma arabası 17 sıralı olup, ray aralıkları 8,5 cm'dir. Tepsi taşıma arabası, tepşilerin düşmemesi için arkada sabit, önde portatif kilitleli çubukla desteklenmiştir. Böylece tepşileri taşıırken ani hareketlerde tepşiler düşmez.
ENG 2 Frenli 2 frensiz 360° tekerlek istemi

Tray trolley with 17 floors and floor ranges 8,5 cm
Tray trolley with front and behind stopper for tray not fall
2 Stopper 2 not stopper 360° wheels



! BARDAKLIK RAFI OPSİYONU
OPTIONAL SHELF FOR GLASS

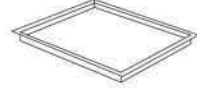

! TUTMA KOLU OPSİYONU
OPTIONAL HANDLE

FY353751 80x55x160

ÇİFTLİ TEPŞİ TAŞIMA ARABASI (37x53)

31 KG

DOUBLE TRAY CARRYING TROLLEY

TR Tepsi taşıma arabası 17+17 sıralı olup, ray aralıkları 8,5 cm'dir. Tepsi taşıma arabası, tepşilerin düşmemesi için arkada sabit, önde portatif kilitleli çubukla desteklenmiştir. Böylece tepşileri taşıırken ani hareketlerde tepşiler düşmez.
ENG 2 Frenli 2 frensiz 360° tekerlek istemi

Tray trolley with 17+17 floors and floor ranges 8,5 cm
Tray trolley with front and behind stopper for tray not fall
2 Stopper 2 not stopper 360° wheels



! BARDAKLIK RAFI OPSİYONU
OPTIONAL SHELF FOR GLASS



-Tekerler ayrıca ücretlendirilecektir.
-Stoppers will be extra charged.



FY463702 45x65x160

TEKLİ TEPŞİ TAŞIMA ARABASI (40x60)

21 KG

SINGLE TRAY CARRYING TROLLEY

TR Tepsi taşıma arabası 20 sıralı olup, ray aralıkları 7 cm'dir. Tepsi taşıma arabası, tepşilerin düşmemesi için arkada sabit, önde portatif kilitleli çubukla desteklenmiştir. Böylece tepşileri taşıırken ani hareketlerde tepşiler düşmez.
ENG 2 Frenli 2 frensiz 360° tekerlek sistemi

Tray trolley with 20 floors and floor ranges 7 cm
Tray trolley with front and behind stopper for tray not fall
2 Stopper 2 not stopper 360° wheels

FY463752 85x65x160

ÇİFTLİ TEPŞİ TAŞIMA ARABASI (40x60)

34 KG

DOUBLE TRAY CARRYING TROLLEY

TR Tepsi taşıma arabası 20+20 sıralı olup, ray aralıkları 7 cm'dir. Tepsi taşıma arabası, tepşilerin düşmemesi için arkada sabit, önde portatif kilitleli çubukla desteklenmiştir. Böylece tepşileri taşıırken ani hareketlerde tepşiler düşmez.
ENG 2 Frenli 2 frensiz 360° tekerlek sistemi

Tray trolley with 20+20 floors and floor ranges 7 cm
Tray trolley with front and behind stopper for tray not fall
2 Stopper 2 not stopper 360° wheels



1 Takım Tekerlek;



20 €



FY693951 60x90x50/90

KAZAN TAŞIMA ARABASI

18 KG

TR

BOILER TRANSPORT TROLLEY

Paslanmaz çelik gövdeli
Tek taraflı tutma kolu
Ekstra takviyeli tabla
2 Frenli 2 frensiz 360° tekerlek sistemi

ENG

*Stainless steel body
Cylinder handle on one side
2 Stopper 2 not stopper 360° wheels*



-Tekerler ayrıca ücretlendirilecektir.
-Stoppers will be extra charged.



FY693901 60x90x20/90

PLATFORM (YÜK) ARABASI

16 KG

TR

PLATFORM TROLLEY

Paslanmaz çelik gövdeli
Tek taraflı tutma kolu
Ekstra takviyeli tabla
2 Frenli 2 frensiz 360° tekerlek sistemi

ENG

*Stainless steel body
Cylinder handle on one side
2 Stopper 2 not stopper 360° wheels*



-Tekerler ayrıca ücretlendirilecektir.
-Stoppers will be extra charged.

1 Takım Tekerlek;



20 €



FY174001 115x70x20/200

ET ASKI ARABASI

28 KG

FY174002 140x70x20/200

ET ASKI ARABASI

31 KG

FY174003 190x70x20/200

ET ASKI ARABASI

35 KG

TR

MEAT HANGER TROLLEYS

Paslanmaz çelik gövdeli
Silindirik askı borusu
Portatif kan tavası
2 Frenli 2 frensiz 360° tekerlek sistemi

ENG

*Stainless steel body
Cylinder hanger
Portable pool for blood
2 Stopper 2 not stopper 360° wheels*



ET KANÇALARI FİYATA DAHİL DEĞİLDİR. / MEAT HOOKS, IS NOT INCLUDED IN OUR PRICES.

85x55x85 FY853801

18 KG İKİ KATLI SERVİS ARABASI

DOUBLE FLOOR SERVICE TROLLEY

Paslanmaz çelik gövdeli
Çift taraflı tutma kolu
2 Frenli 2 frensiz 360° tekerlek istemi

TR
ENG

*Stainless steel body
Cylinder handle on double side
2 Stopper 2 not stopper 360° wheels*

! -Tekerler ayrıca ücretlendirilecektir.
-Stoppers will be extra charged.



85x55x85 FY853802

22 KG ÜÇ KATLI SERVİS ARABASI

THREE FLOOR SERVICE TROLLEY

Paslanmaz çelik gövdeli
Çift taraflı tutma kolu
2 Frenli 2 frensiz 360° tekerlek istemi

TR
ENG

*Stainless steel body
Cylinder handle on double side
2 Stopper 2 not stopper 360° wheels*

! -Tekerler ayrıca ücretlendirilecektir.
-Stoppers will be extra charged.



85x55x85 FY853851

19 KG İKİ KATLI HAVUZLU SERVİS ARABASI

DOUBLE FLOOR SERVICE TROLLEY WITH POOL

Paslanmaz çelik gövdeli
Çift taraflı tutma kolu
Havuzlu katlar havuz derinliği 10 cm
2 Frenli 2 frensiz 360° tekerlek istemi

TR
ENG

*Stainless steel body
Cylinder handle on double side
Pool floor h: 10 cm
2 Stopper 2 not stopper 360° wheels*

! -Tekerler ayrıca ücretlendirilecektir.
-Stoppers will be extra charged.



85x55x85 FY853852

23 KG ÜÇ KATLI HAVUZLU SERVİS ARABASI

THREE FLOOR SERVICE TROLLEY WITH POOL

Paslanmaz çelik gövdeli
Çift taraflı tutma kolu
Havuzlu katlar havuz derinliği 10 cm
2 Frenli 2 frensiz 360° tekerlek istemi

TR
ENG

*Stainless steel body
Cylinder handle on double side
Pool floor h: 10 cm
2 Stopper 2 not stopper 360° wheels*

! -Tekerler ayrıca ücretlendirilecektir.
-Stoppers will be extra charged.



1 Takım Tekerlek;
20 €

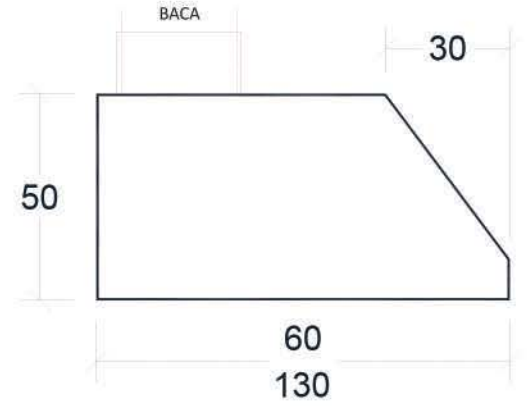

DUVAR TİPİ FİLTRESİZ DAVLUMBAZLAR

		GENİŞLİK (cm) / WIDTH (cm)									
		60	70	80	90	100	110	120	130	140	150
UZUNLUK (cm) / LENGTH (cm)	100	16	18	19	21	22	24	25	27	29	30
	150	21	23	25	28	29	31	33	35	37	39
	200	27	29	31	34	36	38	40	43	45	47
	250	32	35	37	40	43	45	48	51	53	56
	300	38	41	43	47	50	52	56	58	62	64
	350	43	46	50	53	56	59	63	66	69	73
	400	49	52	56	59	63	67	70	74	78	81
	450	54	58	62	66	70	74	78	82	86	90
	500	60	64	68	73	77	81	86	90	95	99
	550	65	69	74	79	84	89	93	98	102	107
600	70	75	80	85	90	96	101	106	111	116	
650	76	81	86	92	97	103	108	113	119	124	
700	81	87	92	98	104	110	116	122	127	133	

AÇIKLAMALAR \ DESCRIPTIONS

TR

DUVAR TİPİ FİLTRELİ DAVLUMBAZ

- Paslanmaz çelik gövde.
- Kolay temizlenebilir.
- Küresel vana ile biriken yağın atılımı

ENG

WALL TYPE HOOD WITH FILTER

- Stainless steel body.
- Easy to clean.
- Oil discharge with ball valve

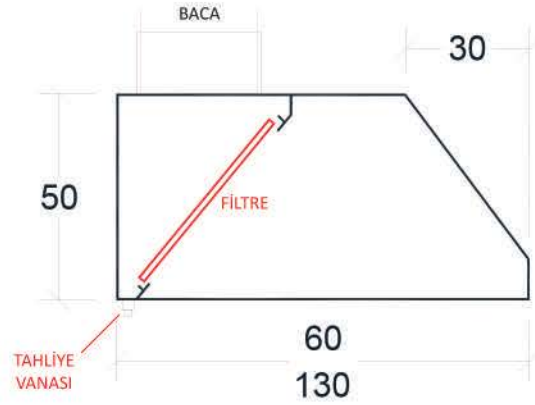

DUVAR TİPİ FİLTRELİ DAVLUMBAZLAR

		GENİŞLİK (cm) / WIDTH (cm)									
		60	70	80	90	100	110	120	130	140	150
UZUNLUK (cm) / LENGTH (cm)	100	19	20	21	23	25	26	29	30	31	33
	150	25	27	29	31	32	34	36	37	40	42
	200	30	32	34	36	39	41	43	45	48	51
	250	35	38	41	43	45	49	51	54	56	58
	300	41	44	46	50	53	55	59	62	65	67
	350	47	50	53	56	60	63	66	69	72	76
	400	51	55	59	63	66	69	74	77	80	85
	450	58	61	65	69	73	77	81	85	89	94
	500	63	66	71	75	79	84	88	92	97	102
	550	69	73	77	82	87	91	96	101	106	110
600	73	79	83	88	94	98	103	109	114	119	
650	79	84	90	95	100	106	111	117	122	128	
700	84	91	96	101	107	112	119	124	130	136	

AÇIKLAMALAR \ DESCRIPTIONS

TR

DUVAR TİPİ FİLTRELİ DAVLUMBAZ

- Paslanmaz çelik gövde.
- Kolay temizlenebilir.
- Küresel vana ile biriken yağın atılımı
- Alevsavar filtreli sistem

ENG

WALL TYPE HOOD WITH FILTER

- Stainless steel body.
- Easy to clean.
- Oil discharge with ball valve
- Filter system



Filtreler fiyata dahil değildir.

- Her 50 cm için 1 adet filtre kullanılmaktadır. Filtre ücreti 10 €'dur.
- 1 Filter is using for every 50 cm. Filter price is 10 €.

NÖTRSET / DAVLUMBAZLAR

NOTRSET / HOODS

NÖTRSET
NOTRSET

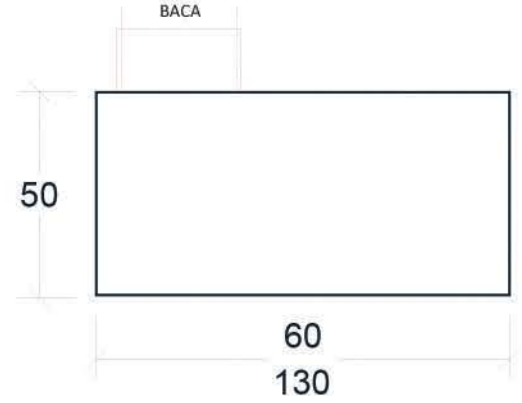

KUTU TİPİ FİLTRESİZ DAVLUMBAZLAR

		GENİŞLİK (cm) / WIDTH (cm)									
		60	70	80	90	100	110	120	130	140	150
UZUNLUK (cm) / LENGTH (cm)	100	16	18	19	21	22	24	25	27	29	30
	150	21	23	25	28	29	31	33	35	37	39
	200	27	29	31	34	36	38	40	43	45	47
	250	32	35	37	40	43	45	48	51	53	56
	300	38	41	43	47	50	52	56	58	62	64
	350	43	46	50	53	56	59	63	66	69	73
	400	48	52	56	59	63	67	70	74	78	81
	450	54	58	62	66	70	74	78	82	86	90
	500	59	64	68	73	77	81	86	90	95	99
	550	65	69	74	79	84	89	93	98	102	107
	600	70	75	80	85	90	96	101	106	111	116
650	76	81	86	92	97	103	108	113	119	124	
700	81	87	92	98	104	110	116	122	127	133	

AÇIKLAMALAR \ DESCRIPTIONS

TR

DUVAR TİPİ FİLTRESİZ DAVLUMBAZ

- Paslanmaz çelik gövde.
- Kolay temizlenebilir.
- Küresel vana ile biriken yağın atılımı

ENG

WALL TYPE HOOD WITH NO FILTER

- Stainless steel body.
- Easy to clean.
- Oil discharge with ball valve

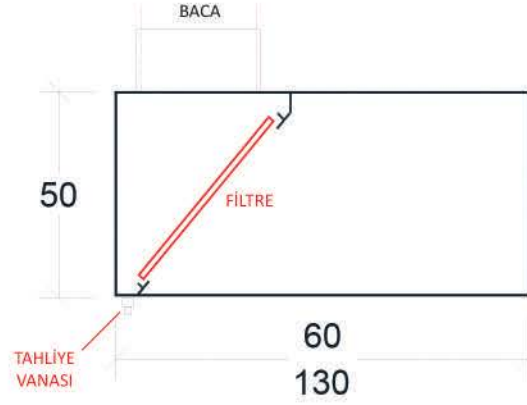

KUTU TİPİ FİLTRELİ DAVLUMBAZLAR

GENİŞLİK (cm) / WIDTH (cm)

	60	70	80	90	100	110	120	130	140
100	20	21	23	24	26	27	29	30	32
150	27	29	31	33	34	36	38	40	42
200	34	36	39	41	43	46	47	50	52
250	41	44	47	49	51	54	57	60	62
300	49	52	55	58	60	63	66	70	72
350	57	60	63	67	70	73	77	80	83
400	64	68	71	75	79	83	86	90	94
450	71	75	79	83	87	91	96	100	104
500	79	83	87	92	96	101	105	109	114
550	86	91	95	100	105	110	114	119	124
600	93	98	103	108	113	119	124	129	134
650	101	106	112	117	123	128	134	139	144
700	108	114	120	125	131	137	143	149	155

AÇIKLAMALAR \ DESCRIPTIONS

TR

DUVAR TİPİ FİLTRELİ DAVLUMBAZ

- Paslanmaz çelik gövde.
- Kolay temizlenebilir.
- Küresel vana ile biriken yağın atılımı
- Alevsavar filtreli sistem

WALL TYPE HOOD WITH FILTER

- Stainless steel body.
- Easy to clean.
- Oil discharge with ball valve
- Filter system

ENG

- Paslanmaz çelik gövde.
- Easy to clean.
- Oil discharge with ball valve
- Filter system



Filtreler fiyata dahil değildir.

- Her 50 cm için 1 adet filtre kullanılmaktadır. Filtre ücreti 10 €'dur.
- 1 Filter is using for every 50 cm. Filter price is 10 €.

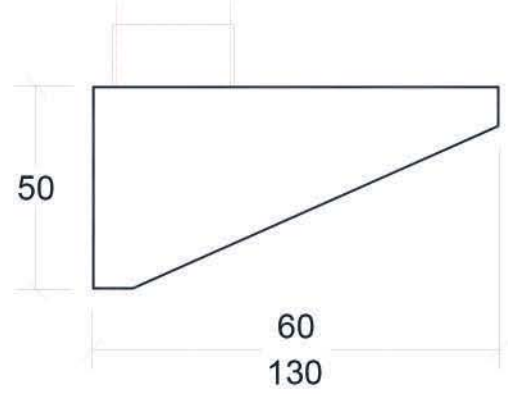

KAFETERYA TİPİ FİLTRESİZ DAVLUMBAZLAR

		GENİŞLİK (cm) / WIDTH (cm)									
		60	70	80	90	100	110	120	130	140	150
UZUNLUK (cm) / LENGTH (cm)	100	14	15	16	17	18	19	20	21	22	23
	150	18	19	20	21	23	24	26	27	28	29
	200	23	24	25	28	30	31	32	35	36	37
	250	27	29	31	33	37	39	41	43	44	46
	300	32	34	36	38	40	43	46	50	53	56
	350	39	43	47	51	55	59	62	65	69	73
	400	45	48	51	55	59	63	68	72	76	79
	450	50	53	55	59	63	68	73	77	81	85
	500	55	59	62	66	70	75	78	81	87	92
	550	60	63	67	70	76	82	86	90	92	95
	600	65	69	72	76	84	89	92	97	101	104
650	71	76	80	85	90	94	99	104	108	112	
700	79	83	87	91	96	101	107	111	115	118	

AÇIKLAMALAR \ DESCRIPTIONS

TR

KAFETERYA TİPİ FİLTRESİZ DAVLUMBAZ

- Paslanmaz çelik gövde.
- Kolay temizlenebilir.
- Küresel vana ile biriken yağın atılımı

ENG

WALL TYPE HOOD WITH NO FILTER

- Stainless steel body.
- Easy to clean.
- Oil discharge with ball valve

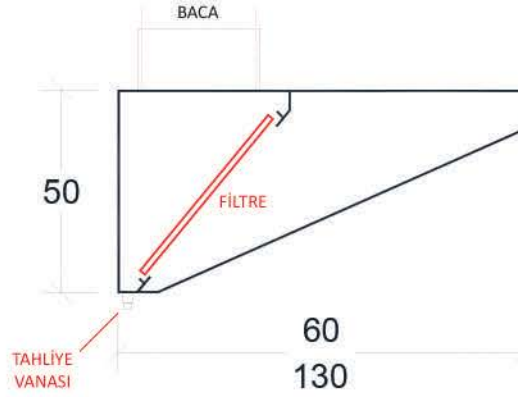

KAFETERYA TİPİ FİLTRELİ DAVLUMBAZLAR

UZUNLUK (cm) / LENGTH (cm)	GENİŞLİK (cm) / WIDTH (cm)									
	60	70	80	90	100	110	120	130	140	150
100	17	18	19	20	21	22	23	24	25	26
150	21	22	23	24	26	27	29	30	31	32
200	27	28	29	32	34	35	36	39	40	41
250	31	33	35	37	41	43	45	47	48	50
300	37	39	41	43	45	48	51	55	58	61
350	44	48	52	56	60	64	67	70	74	78
400	51	54	57	61	65	69	74	78	82	85
450	56	59	61	65	69	74	79	83	87	91
500	62	66	69	73	77	82	85	88	94	99
550	67	70	74	77	83	89	93	97	99	102
600	73	77	80	84	92	97	100	105	109	112
650	80	85	89	94	99	103	108	113	117	121
700	89	93	97	101	106	111	117	121	125	128

AÇIKLAMALAR \ DESCRIPTIONS

- TR** KAFETERYA TİPİ FİLTRELİ DAVLUMBAZ
- Paslanmaz çelik gövde:
 - Kolay temizlenebilir.
- ENG** Küresel vana ile biriken yağın atılımı
- Alevsavar filtreli sistem

- CAFE TYPE HOOD WITH FILTER**
- Stainless steel body,
 - Easy to clean.
 - Oil discharge with ball valve
 - Filter system



Filtreler fiyata dahil değildir.

-Her 50 cm için 1 adet filtre kullanılmaktadır. Filtre ücreti 10 €'dur.
-1 Filter is using for every 50 cm. Filter price is 10 €.

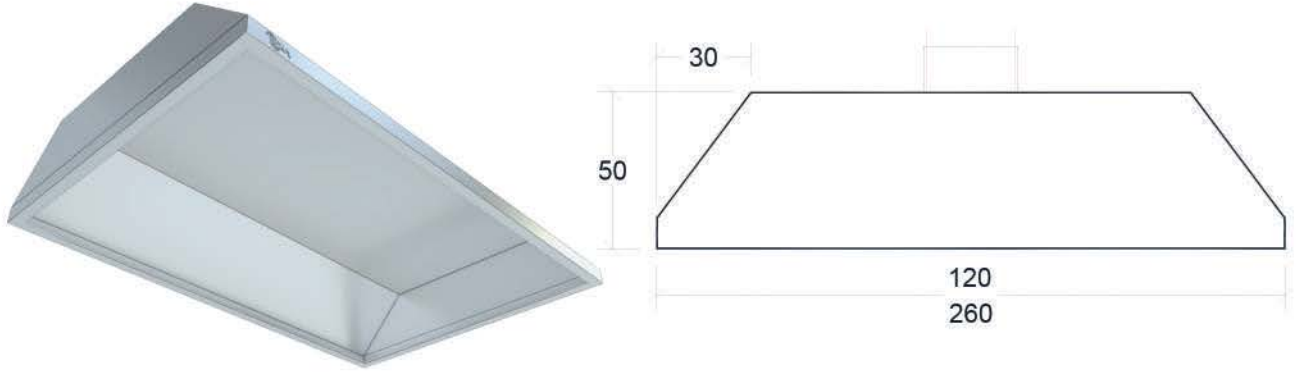

ORTA TİP FİLTRESİZ DAVLUMBAZLAR

		GENİŞLİK (cm) / WIDTH (cm)						
		120	140	160	180	200	220	240
UZUNLUK (cm) / LENGTH (cm)	100	26	30	31	36	39	42	45
	150	35	39	42	46	50	54	60
	200	43	47	52	57	61	65	70
	250	51	56	62	67	72	77	83
	300	59	65	71	77	83	89	95
	350	68	74	81	87	94	101	107
	400	76	83	90	97	105	112	119
	450	84	92	100	108	116	124	132
	500	92	101	109	118	127	135	144
	550	100	109	119	129	138	147	157
600	108	118	129	139	149	160	169	
650	117	127	138	149	160	171	182	
700	125	136	149	160	171	183	194	

AÇIKLAMALAR \ DESCRIPTIONS

TR

ORTA TİP FİLTRELİ DAVLUMBAZ

- Paslanmaz çelik gövde.

- Kolay temizlenebilir.

ENG

- Küresel vana ile biriken yağın atılımı

MEDIUM TYPE HOOD WITH NO FILTER

- Stainless steel body.

- Easy to clean.

- Oil discharge with ball valve

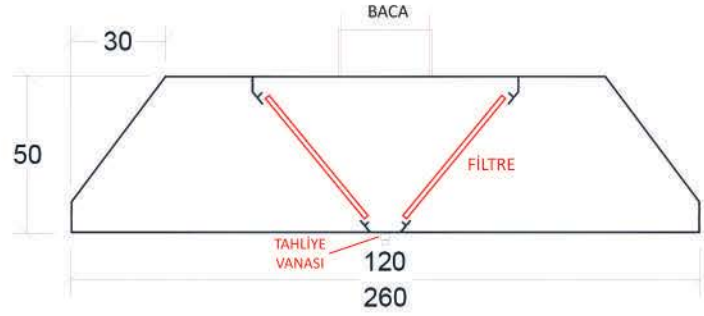

ORTA TİP FİLTRELİ DAVLUMBAZLAR

		GENİŞLİK (cm) / WIDTH (cm)						
		120	140	160	180	200	220	240
UZUNLUK (cm) / LENGTH (cm)	100	30	33	36	40	43	46	50
	150	38	40	45	51	54	58	62
	200	47	51	55	60	65	69	74
	250	54	60	65	70	76	81	86
	300	62	68	75	81	87	93	99
	350	70	78	84	91	98	105	111
	400	79	86	94	101	108	116	124
	450	87	96	103	111	120	128	136
	500	95	104	113	122	131	140	149
	550	103	113	122	132	142	151	161
600	112	121	132	142	153	163	173	
650	120	131	142	153	164	175	186	
700	128	140	151	163	175	186	198	

AÇIKLAMALAR \ DESCRIPTIONS

TR

ORTA TİP FİLTRELİ DAVLUMBAZ

- Paslanmaz çelik gövde.

- Kolay temizlenebilir.

- Küresel vana ile biriken yağın atılımı

- Alevsavar filtreli sistem

MEDIUM TYPE HOOD WITH FILTER

- Stainless steel body.

- Easy to clean.

- Oil discharge with ball valve

- Filter system

ENG

Filtreler fiyata dahil değildir.

-Her 50 cm için 1 adet filtre kullanılmaktadır. Filtre ücreti 10 €'dur.

-1 Filter is using for every 50 cm. Filter price is 10 €.



KUTU ORTA TİP FİLTRESİZ DAVLUMBAZLAR

		GENİŞLİK (cm) / WIDTH (cm)							
		120	140	160	180	200	220	240	
UZUNLUK (cm) / LENGTH (cm)	100	26	31	33	36	40	43	46	
	150	35	39	42	47	50	54	58	
	200	43	48	52	57	61	65	70	
	250	51	56	62	68	72	76	83	
	300	58	66	70	78	83	87	95	
	350	70	78	85	92	99	105	115	
	400	79	87	94	102	110	116	127	
	450	88	96	102	112	121	127	139	
	500	97	105	111	122	132	138	151	
	550	106	113	121	132	143	149	163	
	600	114	123	131	142	154	160	175	
	650	129	133	145	156	172	176	188	
	700	138	144	155	166	183	187	200	

AÇIKLAMALAR \ DESCRIPTIONS

TR

KUTU ORTA TİP FİLTRELİ DAVLUMBAZ

- Paslanmaz çelik gövde.
- Kolay temizlenebilir.
- Küresel vana ile biriken yağın atılımı

ENG

BOX MEDIUM TYPE HOOD WITH NO FILTER

- Stainless steel body.
- Easy to clean.
- Oil discharge with ball valve

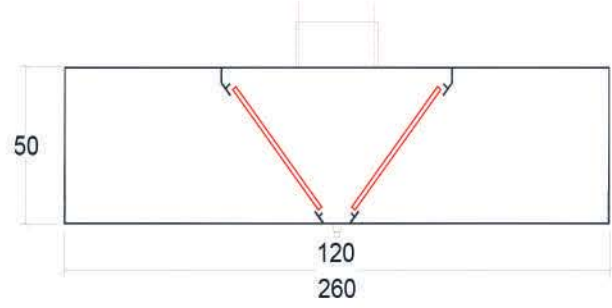

KUTU ORTA TİP FİLTRELİ DAVLUMBAZLAR

		GENİŞLİK (cm) / WIDTH (cm)						
		120	140	160	180	200	220	240
UZUNLUK (cm) / LENGTH (cm)	100	34	37	41	44	46	51	54
	150	42	45	50	55	58	62	66
	200	51	55	60	64	68	74	78
	250	58	64	70	75	80	85	91
	300	67	73	79	85	91	97	103
	350	75	82	89	95	103	109	116
	400	83	91	98	106	112	120	128
	450	91	100	108	116	125	133	140
	500	100	108	117	126	135	144	153
	550	108	117	127	136	146	156	166
600	116	126	136	147	157	167	178	
650	124	135	146	157	168	179	190	
700	132	144	156	167	179	191	202	

AÇIKLAMALAR \ DESCRIPTIONS

- TR** KUTU ORTA TİP FİLTRELİ DAVLUMBAZ
- Paslanmaz çelik gövde.
 - Kolay temizlenebilir.
 - Küresel vana ile biriken yağın atılımı
 - Alevsavar filtrelili sistem

- BOX MEDIUM TYPE HOOD WITH FILTER**
- Stainless steel body.
 - Easy to clean.
 - Oil discharge with ball valve
 - Filter system

ENG



Filtreler fiyata dahil değildir.

- Her 50 cm için 1 adet filtre kullanılmaktadır. Filtre ücreti 10 €/dur.
- 1 Filter is using for every 50 cm. Filter price is 10 €.

NÖTRSET / KÖMÜRLÜ IZGARALAR

NOTRSET / COAL GRILLS

NÖTRSET
NOTRSET

KENDİNDEN DAVLUMBAZLI KÖMÜRLÜ IZGARALAR

COAL GRILLS WITH HOOD

İZOLELİ / COVERED		İZOLESİZ / NOT COVERED	
EBAT (cm) DIM	FİYAT	EBAT (cm) DIM	FİYAT
80x50x90	550 €	80x50x90	500 €
100x50x100	700 €	100x50x100	600 €
120x50x100	850 €	120x50x100	750 €
150x50x100	1.050 €	150x50x100	900 €
180x50x100	1.250 €	180x50x100	1.100 €
200x50x100	1.400 €	200x50x100	1.200 €
230x50x100	1.600 €	230x50x100	1.400 €
250x50x100	1.750 €	250x50x100	1.500 €
280x50x100	2.000 €	280x50x100	1.700 €
300x50x100	2.100 €	300x50x100	1.800 €

AÇIKLAMALAR \ DESCRIPTIONS

-Yağ akıntısını hapsedici yağdanlık
-Paslanmaz çelik gövde.
-Kolay temizlenebilir.
-Ayarlanabilir rotol ayaklar.
-ısı tuğlaları sayesinde uzun ömürlü kullanım ısıyı uzun süre tutma imkanı

-Grease holder on front
-Stainless steel body.
-Easy to clean.
-Adjustable ball joint feet.
-Long time usable by fire stone



KÖMÜRLÜ IZGARA FİYATLARINA, İSTEDİĞİNİZ ÖLÇÜNÜN YARISI KADAR OLUKLU IZGARA FİYATI DAHİLDİR. 200 cm'LİK BİR IZGARA SİPARİŞ ETTİĞİNİZDE 100 cm'LİK OLUKLU IZGARA ÜRÜNLE BİRLİKTE GELİR.

TR

ENG

COAL GRILL PRICES, THE SIZE YOU WANT INCLUDED PRICE OF GRILLED UP TO HALF. WHEN YOU ORDER A 200 cm GRILL 100 cm CORRUGATED GRILL COMES WITH PRODUCT.

KÖMÜRLÜ IZGARALAR

COAL GRILLS

İZOLELİ / COVERED		İZOLESİZ / NOT COVERED	
EBAT (cm) DIM	FİYAT	EBAT (cm) DIM	FİYAT
80x50x90	300 €	80x50x90	250 €
100x50x100	400 €	100x50x100	300 €
120x50x100	500 €	120x50x100	350 €
150x50x100	600 €	150x50x100	450 €
180x50x100	700 €	180x50x100	540 €
200x50x100	800 €	200x50x100	600 €
230x50x100	900 €	230x50x100	700 €
250x50x100	1.000 €	250x50x100	750 €
280x50x100	1.100 €	280x50x100	850 €
300x50x100	1.200 €	300x50x100	900 €

AÇIKLAMALAR \ DESCRIPTIONS

-Yağ akıntısını hapsedici yağdanlık
-Paslanmaz çelik gövde.
-Kolay temizlenebilir.
-Ayarlanabilir rotol ayaklar.
-ısı tuğlaları sayesinde uzun ömürlü kullanım ısıyı uzun süre tutma imkanı

-Grease holder on front
-Stainless steel body.
-Easy to clean.
-Adjustable ball joint feet.
-Long time usable by fire stone

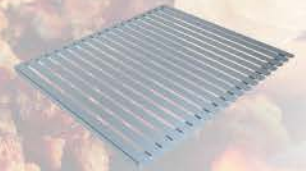

KÖMÜRLÜ IZGARA FİYATLARINA, İSTEDİĞİNİZ ÖLÇÜNÜN YARISI KADAR OLUKLU IZGARA FİYATI DAHİLDİR. 200 cm'LİK BİR IZGARA SİPARİŞ ETTİĞİNİZDE 100 cm'LİK OLUKLU IZGARA ÜRÜNLE BİRLİKTE GELİR.

TR

ENG

COAL GRILL PRICES, THE SIZE YOU WANT INCLUDED PRICE OF GRILLED UP TO HALF. WHEN YOU ORDER A 200 cm GRILL 100 cm CORRUGATED GRILL COMES WITH PRODUCT.

BEKA
ENDÜSTRİYEL MUTFAK



/beka.mutfak



/bekamutfak



www.bekamutfak.com.tr