

JONIX mate Line

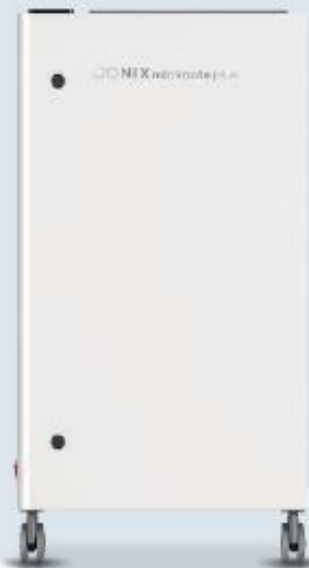

JONIX steel Line



JONIX STEEL

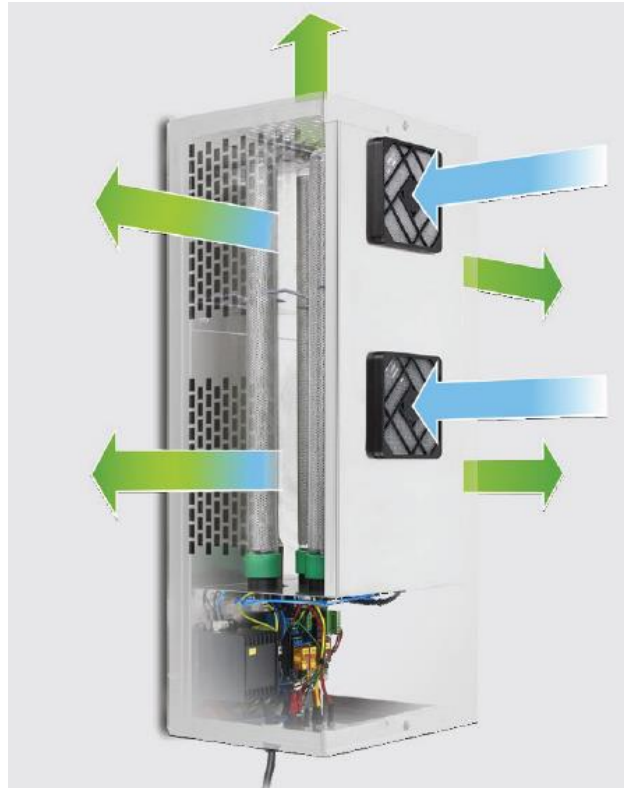

Aisi 304 (stainless steel)

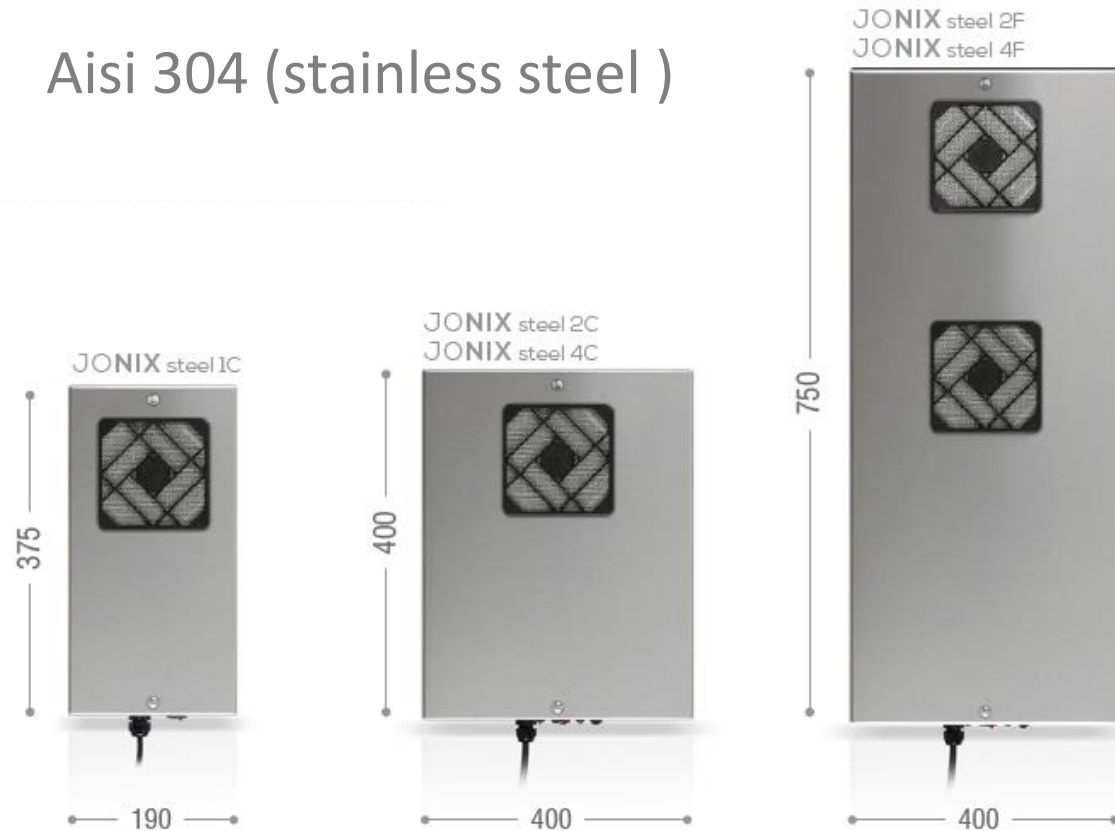

Steel serisi (35 M2 – 600M2)

JONIX up IN

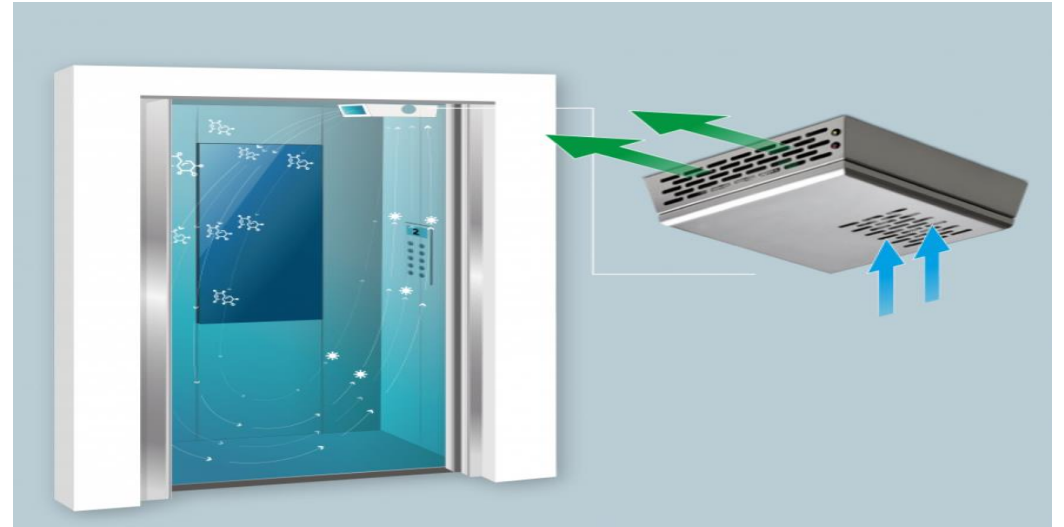

⇒ : air present in the environment. - ⇒ : ionized air flow.

Fig. 16



CEILING FIXING
(only this configuration is possible for lifts and lifting equipment)

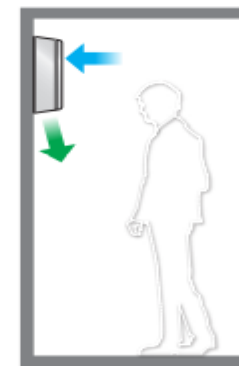

WALL FIXING
Vertical ionized air supply (no for lifts and lifting equipment)

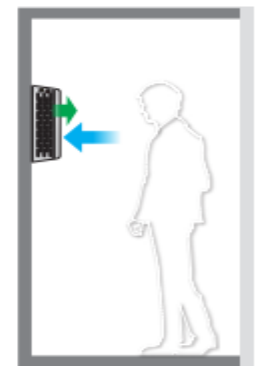

WALL FIXING
Horizontal ionized air supply (no for lifts and lifting equipment)

JONIX inside Line

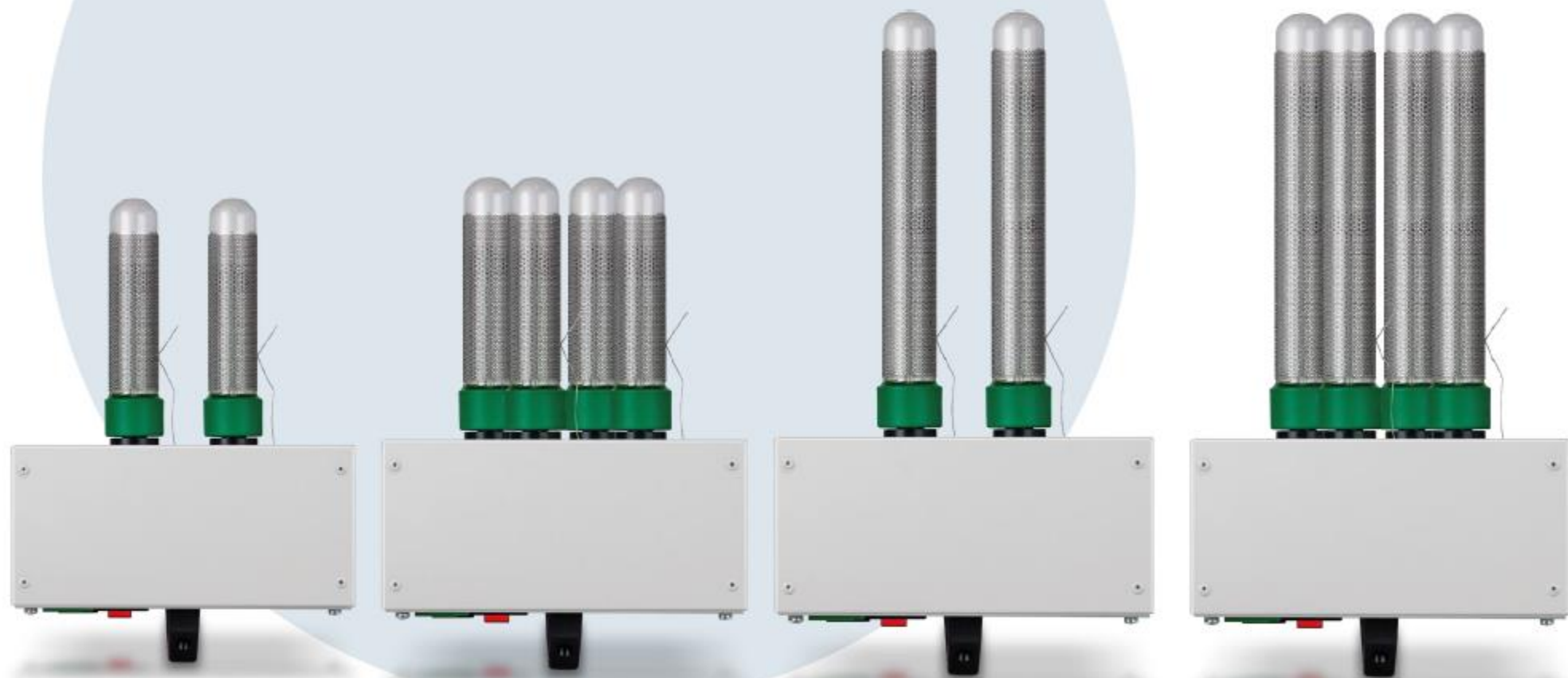

Fancoil uygulaması

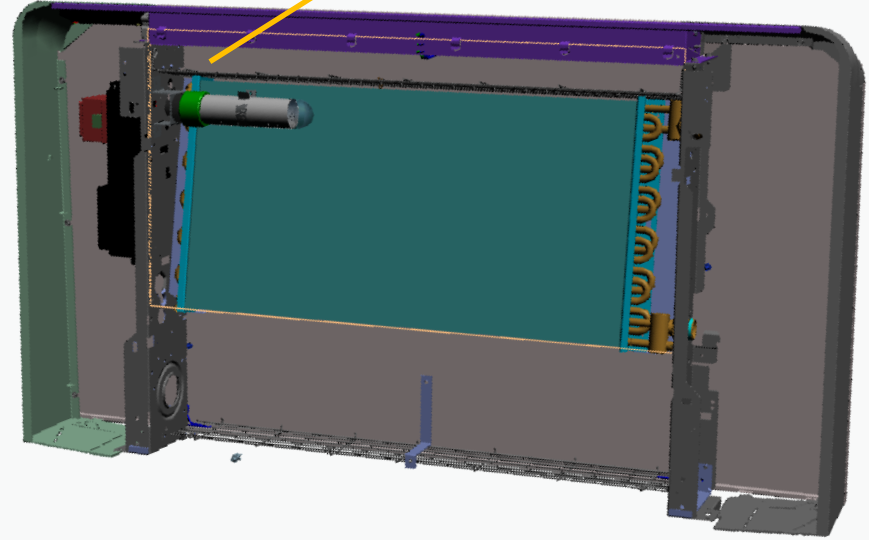

Inside serisi



DUCT 70MIC2C
Dimensions mm: 290 L x 350 P x 200 H
Weight kg: 4
Air flow m³/h: 500
Consumption: 10 W
Power supply: 230 V /- / 50 Hz



DUCT 70MIC4C
Dimensions mm: 290 L x 350 P x 200 H
Weight kg: 5
Air flow m³/h: 1000
Consumption: 8 W
Power supply: 230 V /- / 50 Hz

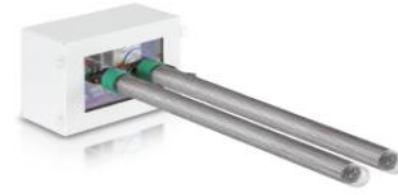

DUCT 70MIC2F
Dimensions mm: 290 L x 350 P x 700 H
Weight kg: 5
Air flow m³/h: 2000
Consumption: 9 W
Power supply: 230 V /- / 50 Hz

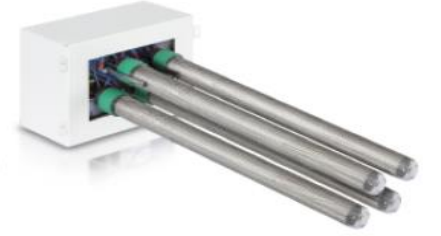

DUCT 70MIC4F
Dimensions mm: 290 L x 350 P x 700 H
Weight kg: 6
Air flow m³/h: 4000
Consumption: 11 W
Power supply: 230 V /- / 50 Hz



Alışveriş Merkezleri



6

Ofisler



Otel – Pansiyon



Doktor / Dişçi / Veteriner



İlaç Sanayi

Gıda Sanayi



7

Inside Serisi – VRF + Isı Geri dönüşüm cihazları

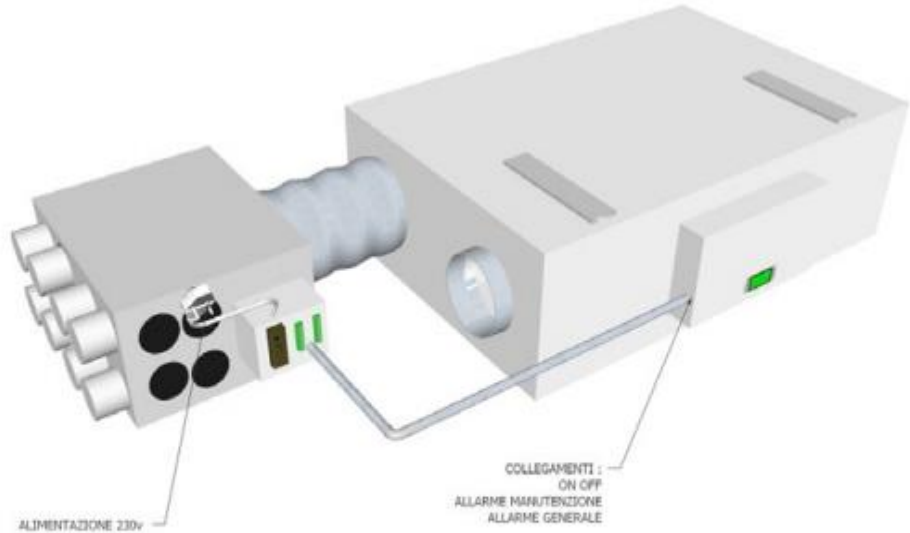
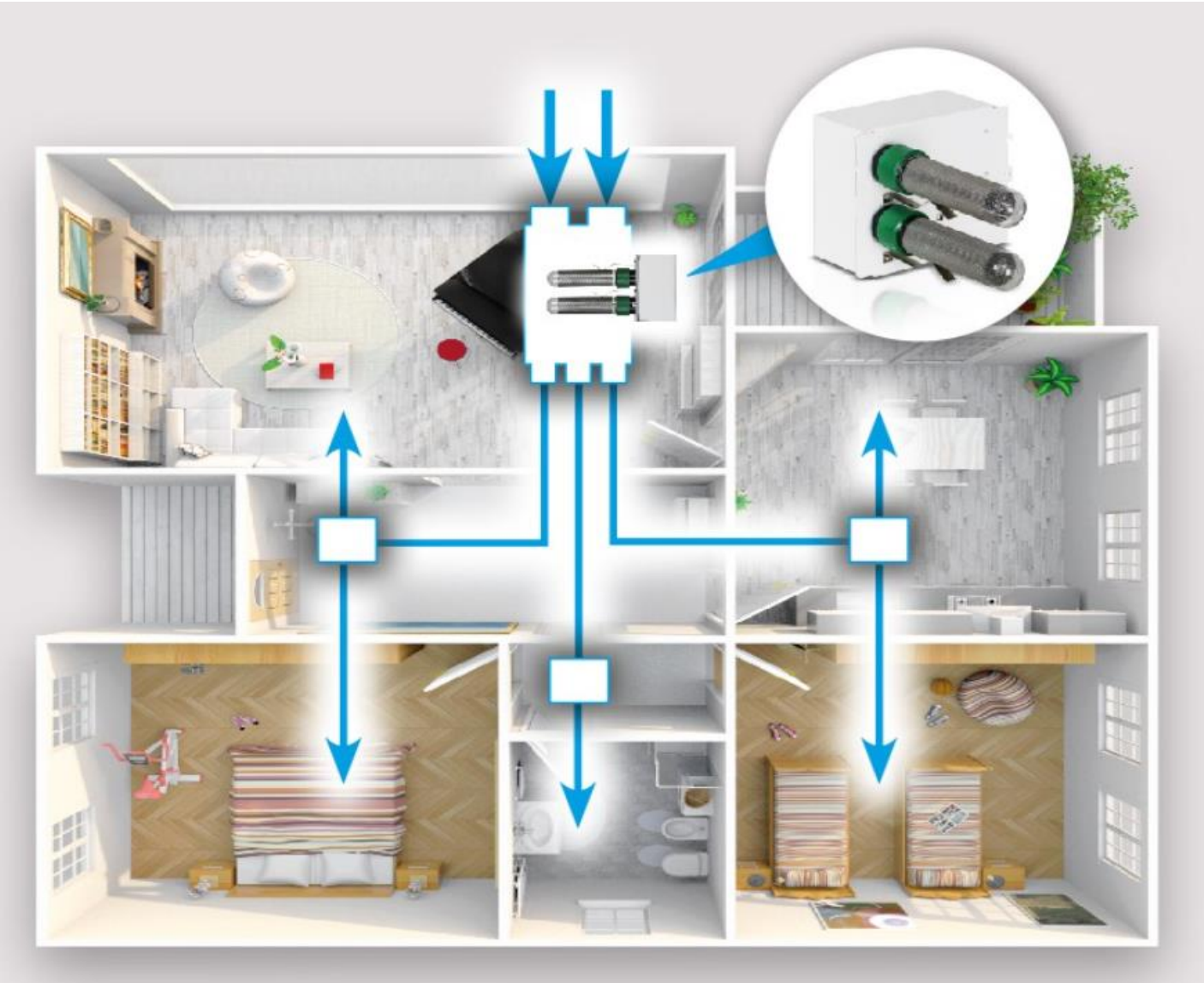

Esempio installazione.

Inside - Uygulama

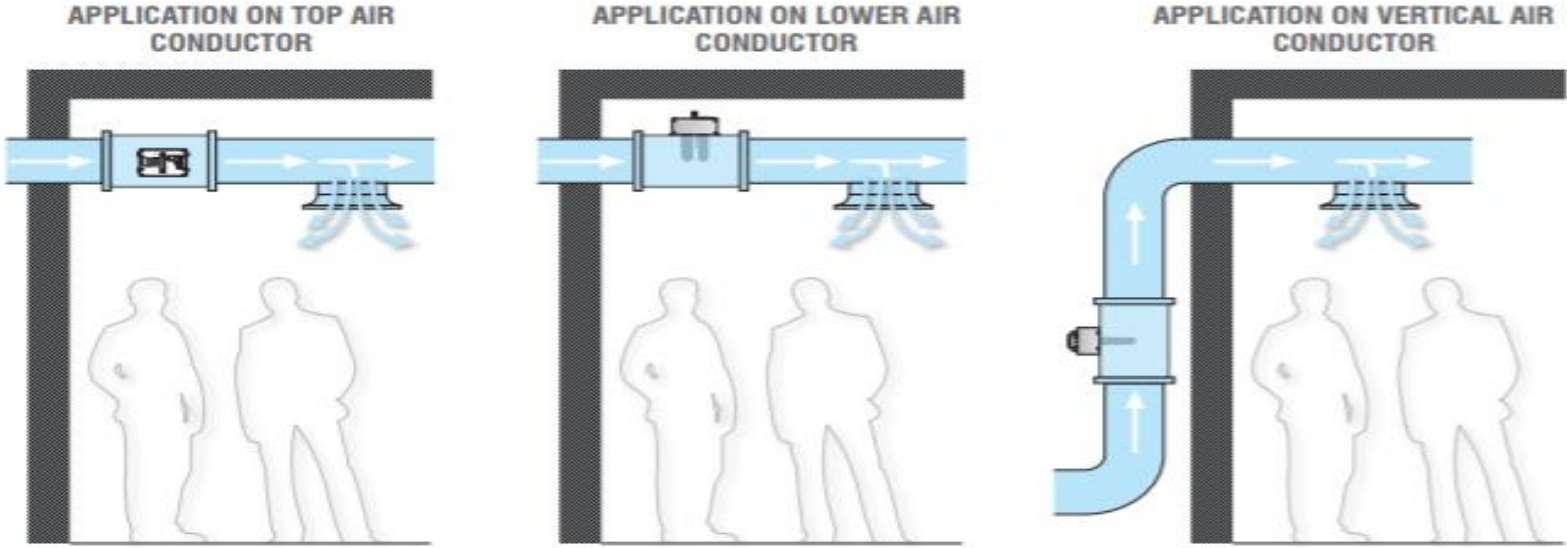

Fastening example of the JONIX duct module on ventilation pipes.

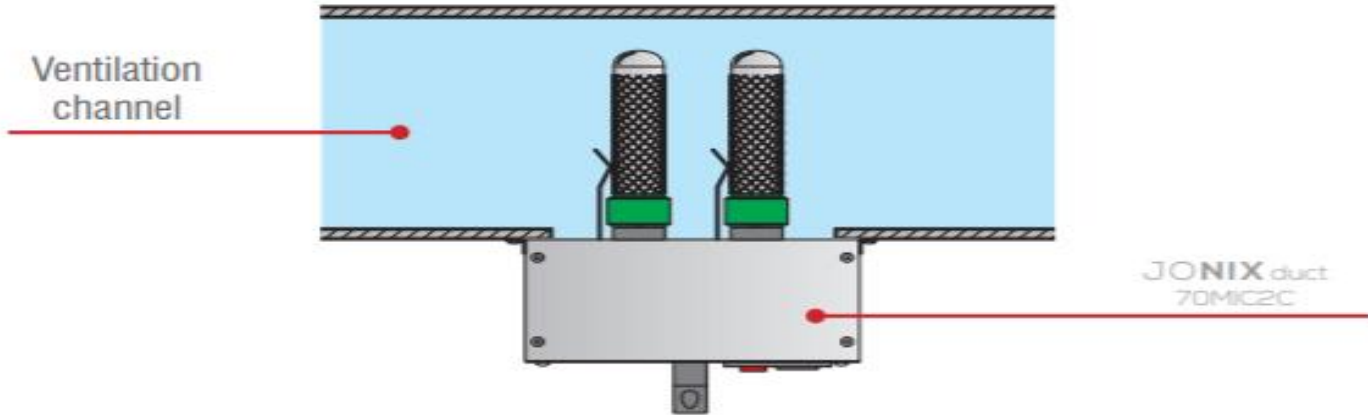

Inside – AHU / Santral Uygulama

JONIX INSIDE AHU

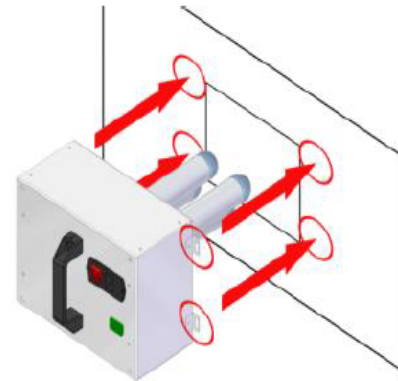

DUCTS

JONIX INSIDE

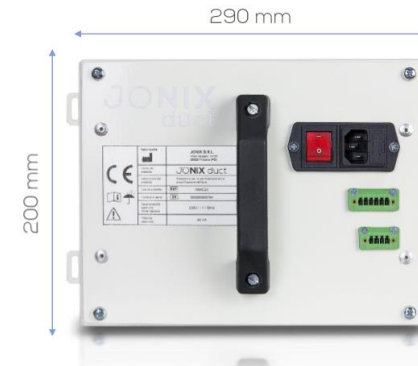

CONNECTION PANEL

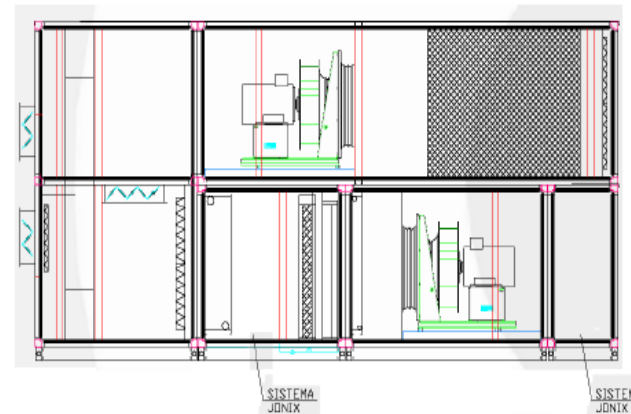

AIR HANDLING UNIT

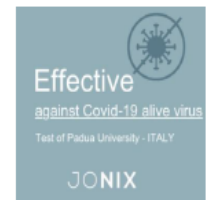

Test ve Sertifikalar

