

As technology continues to improve, we are unable to inform you of the change of our products in time. We apologize for any inconvenience caused!

March 2020



XCMG FOR YOUR SUCCESS



XCMG FOUNDATION CONSTRUCTION MACHINERY BUSINESS DIVISION

Address: No.36 Tuolanshan Road, Jinshanqiao Developing Zone, Xuzhou, Jiangsu, China

Sales and Service Hotline: +86 400-110-9999

Postcode: 221004

[www.xcmg.com/xgjc/](http://www.xcmg.com/xgjc/)



# XR280E

## Rotary Drilling Rig



XCMG FOUNDATION CONSTRUCTION MACHINERY BUSINESS DIVISION

## Highlights Introduction

### ▼01

As a multifunctional machine, XR280E can realize quick function switching such as crowd cylinder, crowd winch, CFA and dual rotary drive to meet different construction needs.

### ▼02

The multi-gear rotary drive and dual motor main winch with single-rope improve the working performance by 20% and ensure higher working efficiency.

### ▼03

Optimally designed double jib luffing mechanism and optimized hinge point position ensure construction stability and transportation convenience.

### ▼04

It adopts H-form hydraulic retractable crawler chassis dedicated for rotary drilling rigs and large diameter slewing bearing, which ensures super stability and convenient transportation.



XR280E rotary drilling rig is a large tonnage product of new generation E series which increases the power and system flow on the basis of mature XR280D to improve working efficiency. It is widely used in the hole-forming operations of cast-in-place concrete piles in the construction of roads, railways, bridges, large venues and other projects, and it is especially suitable for industrial and civil buildings. It adopts mechanical interlocking or friction Kelly bars to work with rotary buckets such as sand drilling bucket, tubular drill and short spiral drill. It can also carry CFA or dual rotary drive for construction.

### ▼05

The intelligent control system can realize functions such as automatic adjustment and display of mast perpendicularity, automatic rotation, spin-off, lifting & concrete pouring and pile type display, etc. The bus panel design is adopted to prevent misoperation.

### ▼06

The main and auxiliary winches both adopt single-rope technology. The service life of the wire rope is 2~4 times longer than that of the multi-row rope and the cost is lower.

### ▼07

The hydraulic system adopts load sensing technology and unites total power control and limit power control technologies, making the hydraulic system more efficient and energy-saving. It adopts independent radiator system with compact structure and high heat dissipation efficiency.

### ▼08

It adopts Volvo electronically controlled turbocharged engine with more power and lower fuel consumption.

## Dimension & Configuration

### Standard

- Self-righting
- Rotation angle display
- Rotation sound-light alarm
- Security monitoring of the tail
- Luffing limit protection
- Mast limit (front and back, left and right)
- Manual/automatic adjustment of mast perpendicularity
- Mast perpendicularity detection
- Cathead cylinder
- Display of rotary drive torque
- Display of rotary drive speed
- Rock-entering mode of rotary drive
- Automatic forward & reverse spin-off
- Casing driving
- Crowd cylinder
- Fuel self-priming pump
- Main winch floating
- Main winch height limit
- Main winch infrared monitoring
- Real-time detection of drilling depth
- Main winch extraction force detection
- Gradienter
- Radio
- Air conditioner
- Oil pressure detection
- Intelligent fault detection
- Filter clogging alarm
- Scram protection
- PLC intelligent control module
- Central lubrication

### Optional

- High-speed spin-off
- Crowd winch
- Torque multiplier
- CFA for rotary drilling rig
- Main winch bottom protection

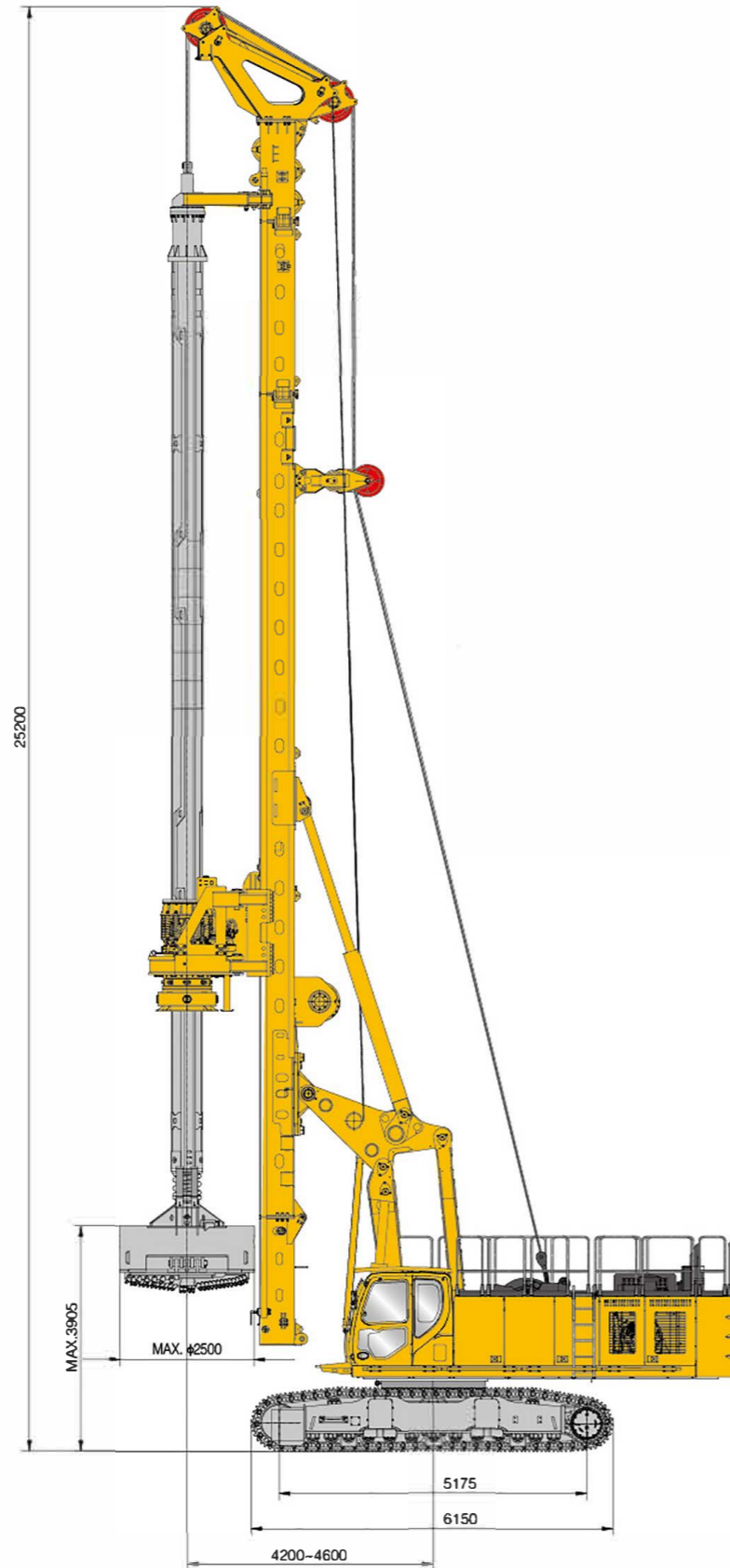

## Main Technical Parameters

Working height	25.5 m	84 ft
Overall operating weight (standard)	106 t (without drilling tools)	116.8 ton(US)
Max. drilling diameter	Φ2500 mm/φ2300 mm*	98.4 in/90.6 in*
Max. drilling depth	94 m	308 ft
<b>Dimensions</b>		
Working condition	10825×4800×25510 mm	426×189×1004 in
Transport condition	17810×3500×3775 mm	701×138×149 in
<b>Engine</b>		
Rated power	315 kW/1900 r/min	422 hp/1900 rpm
Emission standard	EU III	EU III
Fuel tank capacity	800 L	211.3 US gal
<b>Rotary drive</b>		
Rated output torque	280 kNm	206382 lbf*ft
Rotary speed	6-27 r/min	6-27 rpm
<b>Crowd cylinder</b>		
Max. crowd force push/pull	330 kN/330 kN	74187 lbf/74187 lbf
Max. stroke	6 m	20 ft
<b>Crowd winch (optional)</b>		
Max. crowd force push/pull	330 kN/330 kN	74187 lbf/74187 lbf
Max. stroke	13 m	43 ft
<b>Main winch</b>		
Max. pulling force	330 kN	71939 lbf
Max. line speed	75 m/min	246 ft/min
<b>Auxiliary winch</b>		
Max. pulling force	100 kN	22481 lbf
Max. line speed	41 m/min	134 ft/min
<b>Mast inclination</b>		
Lateral/forward/backward	±4°/5°/15°	±4°/5°/15°
<b>Undercarriage</b>		
Max. travel speed of overall unit	1.5 km/h	0.9 mph
Min. ground clearance	445 mm	17.5 in
Width of triple grouser track shoes	800 mm	31.5 in
Width of crawlers retracted/extended	3500-4800 mm	138 -189 in
Max. climbable gradient of overall unit	35%	35%
Ground pressure	125 kPa	18 psi
<b>Hydraulic system</b>		
Hydraulic oil tank capacity	1000 L	264.2 US gal
Working pressure	33 MPa	4786 psi

Note: Parameters with "\*" refer to the ones of crowd winch configuration.

## Rotary Drive

It adopts vertical pin connected power box and bracket, which is more reliable and convenient to assembly and disassembly. The lower cover of the box body has double-layer sealing with good sealing performance and long service life. Casing driving and torque multiplier can be chosen to improve the casing capacity of the rig.

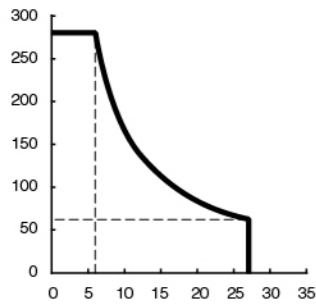
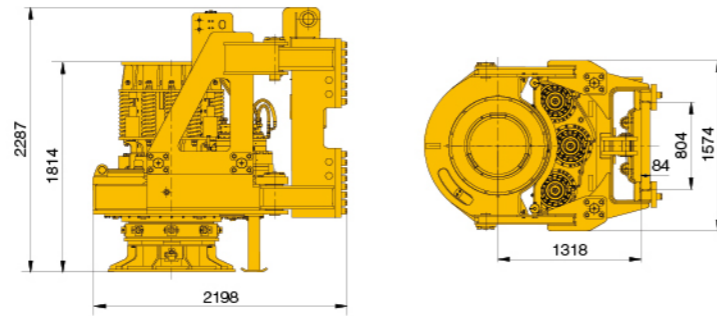

Working mode

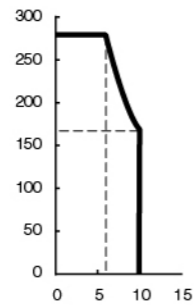

Rock drilling mode

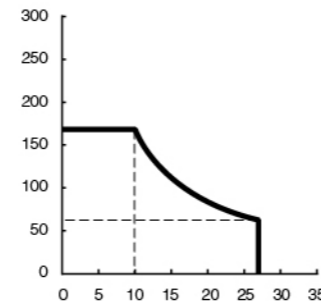

Efficiency mode

## Kelly Bar

Interlocking Kelly bar	Weight		Drilling depth		Height above ground of drilling bit		Casing length (FYI)	
Φ508-4×16.0 m	13645 kg	30082 lb	57 m	186 ft	4 m	13.1 ft	3 m	9.8 ft
Φ508-4×17.0 m	15070 kg	33223 lb	61 m	199 ft	3 m	9.8 ft	2 m	6.6 ft
Friction Kelly bar	Weight		Drilling depth		Height above ground of drilling bit		Casing length (FYI)	
Φ508-5×16.1 m	14500 kg	31966 lb	73 m	239 ft	3.9 m	12.8 ft	3 m	9.8 ft
Φ508-5×17.0 m	15200 kg	33509 lb	78 m	255 ft	3 m	9.8 ft	2 m	6.6 ft
Φ508-6×16.1 m	14030 kg	30930 lb	86 m	281 ft	3.9 m	12.8 ft	3 m	9.8 ft
Φ508-6×17.0 m	15100 kg	33289 lb	92 m	301 ft	3 m	9.8 ft	2 m	6.6 ft
Φ508-6×17.5 m	15500 kg	34171 lb	94 m	307 ft	2.5 m	8.2 ft	1.5 m	4.9 ft

## Transportation Plan

### Whole Machine Transportation

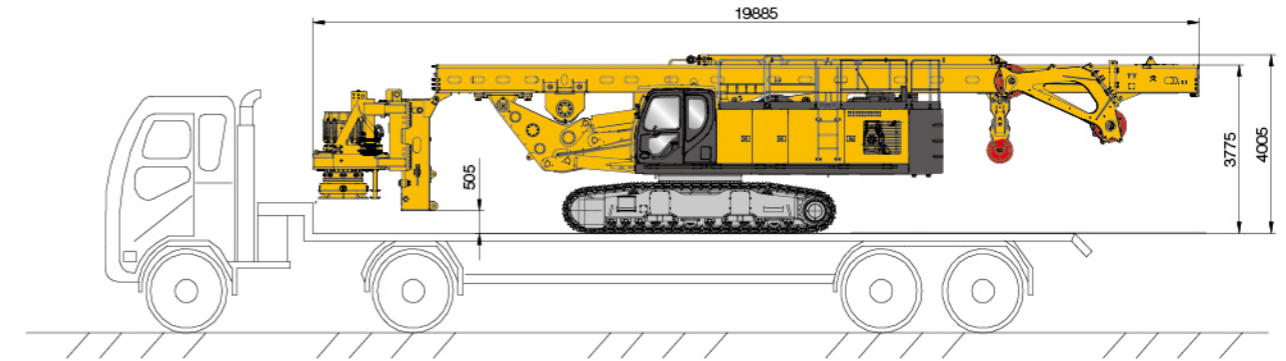

Transport weight: 84.5t (without Kelly bar or drilling tools)  
Transport width: 3500 mm

### Disassembly Transportation

1. Disassemble the Kelly bar and drilling bit
2. Disassemble the counterweight
3. Disassemble the rotary drive
4. Disassemble left and right carling and track assembly
5. Hoist the detached parts and the upper part of the machine onto the trailer and fix them securely

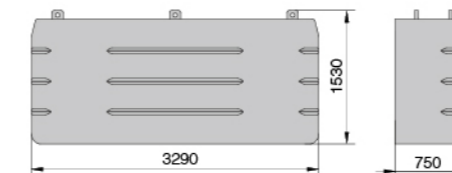

Weight of counterweight: 9 t

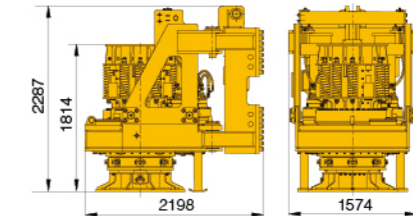

Weight of rotary drive assembly: 7.9 t

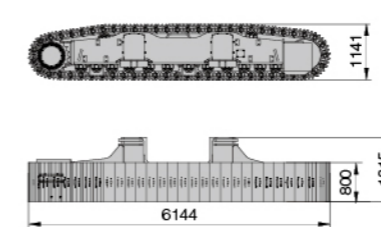

Weight of carling and track: 9.4 t

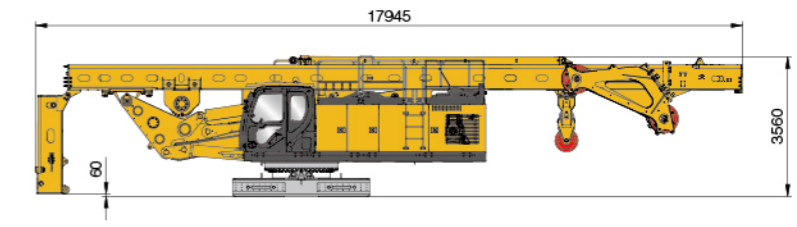

Weight: 49 t; Transport width: 3500 mm

## Construction Cases



## E Series Rotary Drilling Rig

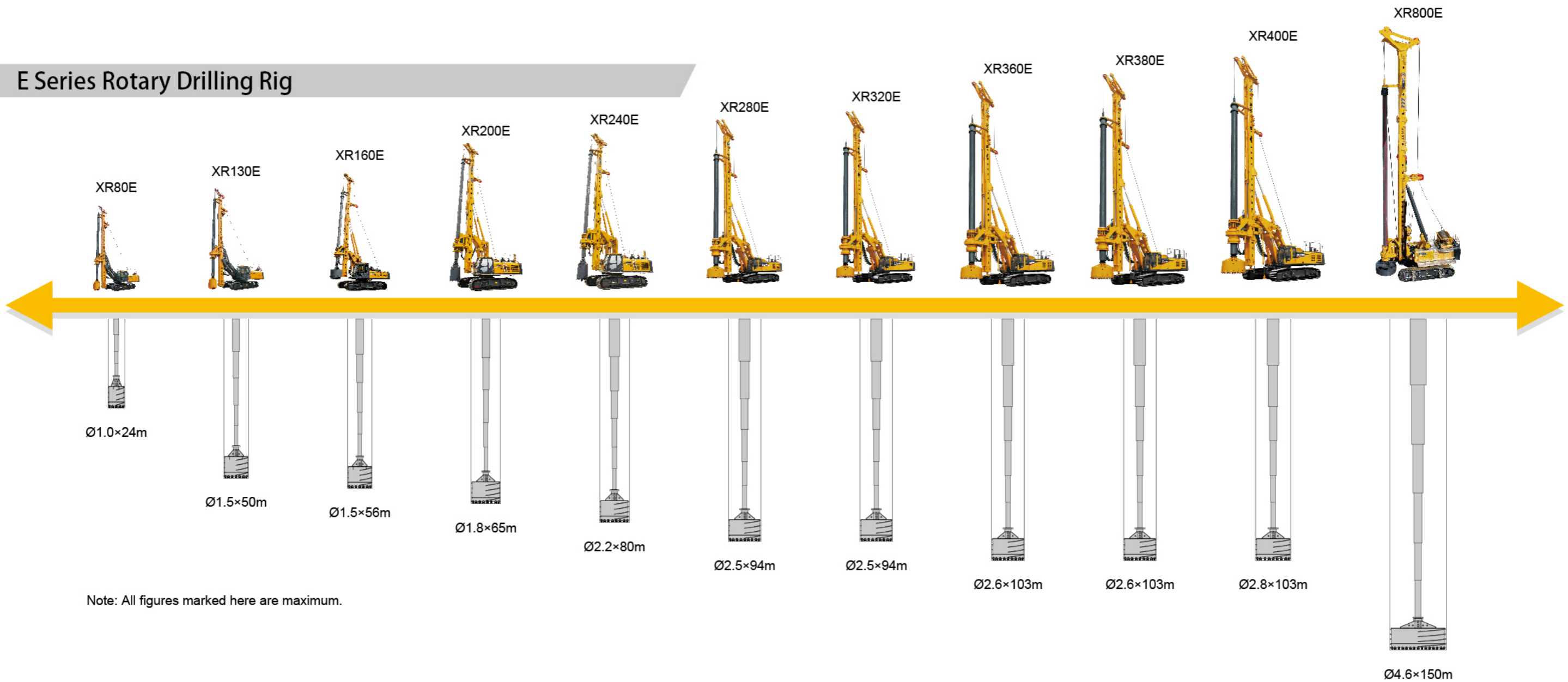

# Drilling Tools

**Main application: gravel cobble and weathered rock**



Double-bottom double-door bucket with cutting teeth



Double-bottom single-door bucket with cutting teeth



Double cut bucket with cutting teeth



Double cut single spiral auger with cutting teeth

**Main application: soil, sand and ooze**

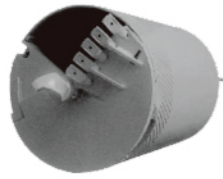

Double-bottom single-door soil bucket



Double-bottom single-door soil bucket



Core barrel with cutting teeth



Core barrel with cone bit

**Main application: hard bed rock and boulder formations**

**Main application: clay, soil, dry construction method**



Split type drill bit



Double cut single spiral soil auger

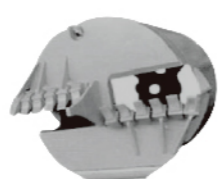

Single-bottom double-door soil bucket

**Main application: cleaning up the sediment at the bottom of the hole**



Cleaning bucket

**Main application: cobble, strong weathered rock, Tundra, broken rock**



Single cut single spiral auger with cutting teeth



Double cut single spiral auger with cutting teeth

**Main application: soil, sand, soft rock**



Belling bucket for soil



Belling bucket for rock

**Others**

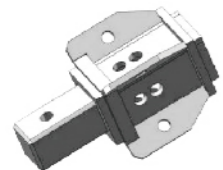

Kelly box adapter



Extension rod



Casing



Betek tooth