

2023 ÜRÜN KATALOĐU



AIR COMPRESSORS & TOOLS

SEKTÖRDE MÜŞTERİ MEMNUNİYETİ İLE DOLU 40. YILA DOĞRU

Demir Hırdavat olarak, kendi markamız GAP ile yurt içi ve yurt dışında üretimini yaptırdığımız hava kompresörleri ile birlikte bugün, sessiz, yağsız ve vidalı hava kompresörleri, hava kurutucuları, araç kaldırma lifleri, lastik ve balans makineleri, oto servis ekipmanları ve endüstriyel depolama sistemleri ile ürün gamımızı sizlerin desteği ile daha geniş bir hale getirdik. Güveninizin eseri GAP markamız ile sizlerin beğenisine sunduğumuz endüstriyel ürünler bugün, ülkemizin dört bir yanında ve yurt dışında sanayicilerimiz tarafından beğeni ile kullanılmaktadır.

NEDEN GAP ?

Uzun yıllar kullanabileceğiniz, kaliteli, yüksek teknoloji ürünlerimiz ile müşterilerimize güven veriyor ve kullanım süresi boyunca servis hattımızdan 7/24 kesintisiz destek sağlıyoruz.

1- Alacağınız ürün sektörde 40 yıla yakın tecrübesi ve birikimi ile Demir Hırdavat ailesinin GAP markasını taşıyacak. GAP markalı ürünlerimizin garanti süresinde ve sonrasında, ihtiyaç duyduğunuz her konuda en etkin hizmeti alacaksınız.

2- GAP markalı ürününüz piyasa koşullarında her zaman fayda maliyet dengesini en üst düzeyde sunar. Ürününüzü değişen ihtiyaçlarınız doğrultusunda yenilemeniz gerektiğinde ise, firmamız eski ürününüzü en iyi fiyattan geri alır ve size yeni ürününüzü anında kapsamlı stoklarından teslim eder.

3- GAP markasının katalogunda olan her ürün, merkez satış noktalarımızda güçlü stoğa sahiptir. İhtiyacınız olan ürünlere anında stoktan sahip olur ve bir kaç iş günü içinde üretim merkezimize kurulumu yapılır.

4- Yaygın servis ağıımız, hızlı ve güleryüzlü servis hizmetimiz sizlerin üretimde kesintiye uğramamanız için yoğun bir şekilde çalışmaktadır. Ülkemizin dört bir yanında anlaşmalı servis noktalarımız ile GAP markalı ürünleriniz her koşulda firmamızın güvencesi altındadır.



www.gapkompresor.com

www.gaptools.net



1986 ' DAN BUGÜNE

40 yıla yakın tecrübemiz ve profesyonel kadromuz ile müşteri memnuyeti için çalışıyor, İkitelli , Topkapı ve Online mağazalarımızdan hizmet sağlıyor, geniş servis ağı ile dünyanın dört bir yanına çözüm üretmeye devam ediyoruz...



GAP[®]
AIR COMPRESSORS & TOOLS

2+1

VİDALI HAVA KOMPRESÖRLERİNDE
2+1 YIL EK GARANTİ
FIRSATI !

Vidalı hava Kompresörlerini
satın aldıktan hemen sonra
ister webden, ister cepten
www.gapkompresor.com
internet sitemize girip
ürününüzü kaydedin.

Garanti süreniz 1 yıl uzayıp,
toplamda 3 yıl olsun.



Bizi Sosyal Medyadan Takip Etmeyi Unutmayın!



Gap Kompresör & Tools



gapkompresor_tools



Gap Kompresör & Tools



PİSTONLU HAVA KOMPRESÖRLERİ



PROFESYONELLER İÇİN EN İYİ ÇÖZÜMLER
BEST SOLUTIONS FOR PROFESSIONALS

50 lt 8 Bar 2 HP Pistonlu Hava Kompresörü - GP 50



Çift Hava Çıkışı



Yağlı Sistem



50 lt Tank

Depo Hacmi	:	50 lt
Güç	:	2 HP / 1.2 KW
Basınç	:	8 Bar
Hava Emişi	:	198 lt/dk
Voltaj	:	220 V
Ağırlık	:	30 kg
Ölçüler	:	68x32x68 cm
Piston Çapı	:	50 mm
Silindir Sayısı	:	1

100 lt 2 Kafa 8 Bar 3 HP Pistonlu Hava Kompresörü - GP 100

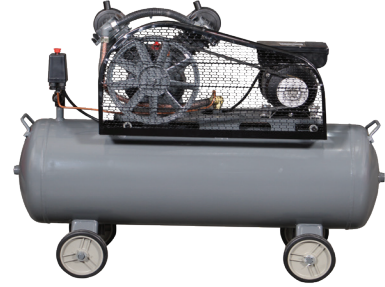

Yağlı Sistem



Döküm Gövde



Çift Piston



100 lt Tank

Depo Hacmi	:	100 lt
Güç	:	3 HP / 2.2 KW
Basınç	:	8 Bar
Hava Emişi	:	250 lt/dk
Voltaj	:	220 V
Ağırlık	:	79 kg
Ölçüler	:	112x45x75 cm
Piston Çapı	:	65 mm
Silindir Sayısı	:	2

200 lt 2 Kafa 8 Bar 3 HP Pistonlu Hava Kompresörü - GP 200

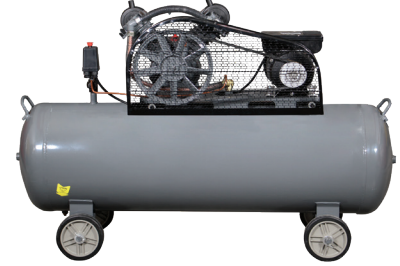
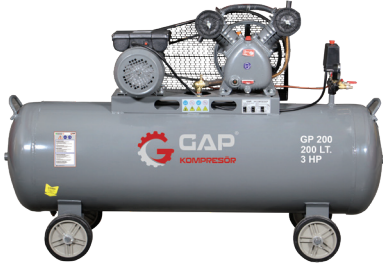

Yağlı Sistem



Döküm Gövde



Çift Piston



200 lt Tank

Depo Hacmi	:	200 lt
Güç	:	3 HP / 2.2 KW
Basınç	:	8 Bar
Hava Emişi	:	350 lt/dk
Voltaj	:	220 V / 380V
Ağırlık	:	123 kg
Ölçüler	:	142x53x98 cm
Piston Çapı	:	65 mm
Silindir Sayısı	:	2

300 lt 2 Kafa 8 Bar 5.5 HP Pistonlu Hava Kompresörü - GP 290

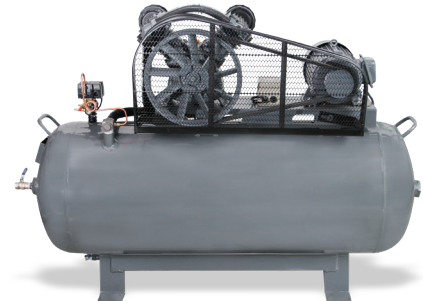

Yağlı Sistem



Döküm Gövde



Yüksek Emiş Gücü



300 lt Tank

Depo Hacmi	:	300 lt
Güç	:	5.5 HP / 4 KW
Basınç	:	8 Bar
Hava Emişi	:	750 lt/dk
Voltaj	:	380 V
Ağırlık	:	191 kg
Ölçüler	:	165x125x60 cm
Piston Çapı	:	90 mm
Silindir Sayısı	:	2

300 lt 2 Kafa 12 Bar 5.5 HP Pistonlu Hava Kompresörü - **GPK 290**



Yağlı Sistem



Döküm Gövde



Yüksek Basınç



300 lt Tank

Depo Hacmi	:	300 lt
Güç	:	5.5 HP / 4 KW
Basınç	:	12 Bar
Hava Emişi	:	550 lt/dk
Voltaj	:	380 V
Ağırlık	:	191 kg
Ölçüler	:	165x125x60 cm
Piston Çapı	:	90/65 mm
Silindir Sayısı	:	2

500 lt 2 Kafa 8 Bar 5.5 HP Pistonlu Hava Kompresörü - **GP 290/500**



Yağlı Sistem



Döküm Gövde



500 lt Tank

Depo Hacmi	:	500 lt
Güç	:	5.5 HP / 4 KW
Basınç	:	8 Bar
Hava Emişi	:	750 lt/dk
Voltaj	:	380 V
Ağırlık	:	211 kg
Ölçüler	:	185x135x70 cm
Piston Çapı	:	90 mm
Silindir Sayısı	:	2

500 lt 3 Kafa 8 Bar 10 HP Pistonlu Hava Kompresörü - GP 390

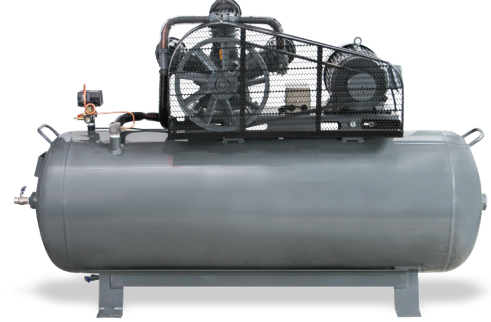

Yağlı Sistem



Döküm Gövde



Yüksek Emiş Gücü



500 lt Tank

Depo Hacmi	:	500 lt
Güç	:	10 HP / 7.5 KW
Basınç	:	8 Bar
Hava Emişi	:	1200 lt/dk
Voltaj	:	380 V
Ağırlık	:	235 kg
Ölçüler	:	185x135x70 cm
Piston Çapı	:	90 mm
Silindir Sayısı	:	3

500 lt 3 Kafa 12 Bar 10 HP Pistonlu Hava Kompresörü - GPK 390

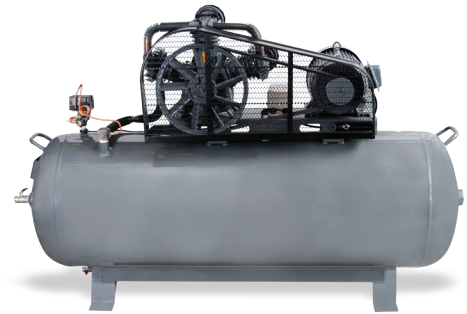

Yağlı Sistem



Döküm Gövde



Yüksek Basınç



500 lt Tank

Depo Hacmi	:	500 lt
Güç	:	10 HP / 7.5 KW
Basınç	:	12 Bar
Hava Emişi	:	900 lt/dk
Voltaj	:	380 V
Ağırlık	:	235 kg
Ölçüler	:	185x135x70 cm
Piston Çapı	:	90 / 65 mm
Silindir Sayısı	:	3



SESSİZ VE YAĞSIZ HAVA KOMPRESÖRLERİ



PROFESYONELLER İÇİN EN İYİ ÇÖZÜMLER
BEST SOLUTIONS FOR PROFESSIONALS

25 Lt Sessiz ve Yağsız Hava Kompresörü - GPS 550



Sessiz ve Yağsız



Selenoid Valf Sistemi



Çift Filtreli



25 Lt Tank

Depo Hacmi	:	25 Lt
Güç (WATT)	:	550 W
Güç (HP)	:	0.75 HP
Basınç	:	8 Bar
Hava Emişi	:	190 lt/dk
Voltaj	:	220 V
Ses Düzeyi	:	55 dB
Ağırlık	:	21.8 kg
Ölçüler	:	58x25x61 cm

50 Lt Sessiz ve Yağsız Hava Kompresörü - GPS 750



Sessiz ve Yağsız



Selenoid Valf Sistemi



Çift Filtreli



50 Lt Tank

Depo Hacmi	:	50 Lt
Güç (WATT)	:	750 W
Güç (HP)	:	1 HP
Basınç	:	8 Bar
Hava Emişi	:	225 lt/dk
Voltaj	:	220 V
Ses Düzeyi	:	58 dB
Ağırlık	:	29 kg
Ölçüler	:	67x32x69 cm

50 lt Sessiz ve Yağsız Hava Kompresörü - GPS 1100



Sessiz ve Yağsız



Solenoid Valf Sistemi



Çift Filtreli



50 lt Tank



Yüksek Emiş Gücü

Depo Hacmi	:	50 lt
Güç (WATT)	:	1100 W
Güç (HP)	:	1.5 HP
Basınç	:	8 Bar
Hava Emişi	:	270 lt/dk
Voltaj	:	220 V
Ses Düzeyi	:	62 dB
Ağırlık	:	39 kg
Ölçüler	:	67X32X69 cm

50 lt Sessiz ve Yağsız Hava Kompresörü - GPS 550x2



Sessiz ve Yağsız



Solenoid Valf Sistemi



4 Filtreli



50 lt Tank



Yüksek Emiş Gücü

Depo Hacmi	:	50 lt
Güç (WATT)	:	550x2 W
Güç (HP)	:	1.5 HP
Basınç	:	8 Bar
Hava Emişi	:	275 lt/dk
Voltaj	:	220 V
Ses Düzeyi	:	60 dB
Ağırlık	:	39 kg
Ölçüler	:	67x32x69 cm

100 Lt Sessiz ve Yağsız Hava Kompresörü - GPS 750x3



Sessiz ve Yağsız



Solenoid Valf Sistemi



6 Filtreli



100 Lt Tank

Depo Hacmi	:	100 Lt
Güç (WATT)	:	750x3 W
Güç (HP)	:	3 HP
Basınç	:	8 Bar
Hava Emişi	:	470 lt/dk
Voltaj	:	220 V
Ses Düzeyi	:	66 dB
Ağırlık	:	80 kg
Ölçüler	:	112x45x75 cm

100 Lt Sessiz ve Yağsız Hava Kompresörü - GPS 1100x3



NEW



Sessiz ve Yağsız



Solenoid Valf Sistemi



6 Filtreli



100 Lt Tank



Yüksek Emiş Gücü

Depo Hacmi	:	100 Lt
Güç (WATT)	:	1100x3 W
Güç (HP)	:	4.5 HP
Basınç	:	8 Bar
Hava Emişi	:	600 lt/dk
Voltaj	:	220 V
Ses Düzeyi	:	69 dB
Ağırlık	:	90 kg
Ölçüler	:	112x45x75 cm

200 lt Sessiz ve Yağsız Hava Kompresörü - GPS 750x3/200



Sessiz ve Yağsız



Solenoid Valf Sistemi



6 Filtreli



200 lt Tank

Depo Hacmi	:	200 lt
Güç (WATT)	:	750x3 W
Güç (HP)	:	3 HP
Basınç	:	8 Bar
Hava Emişi	:	470 lt/dk
Voltaj	:	220 V
Ses Düzeyi	:	66 dB
Ağırlık	:	138 kg
Ölçüler	:	129x46x79 cm

200 lt Sessiz ve Yağsız Hava Kompresörü - GPS 750x4



Sessiz ve Yağsız



Solenoid Valf Sistemi



8 Filtreli



200 lt Tank



Dijital Gösterge

Depo Hacmi	:	200 lt
Güç (WATT)	:	750x4 W
Güç (HP)	:	4 HP
Basınç	:	8 Bar
Hava Emişi	:	550 lt/dk
Voltaj	:	220 V
Ses Düzeyi	:	69 dB
Ağırlık	:	146 kg
Ölçüler	:	129x46x79 cm

200 lt Sessiz ve Yağsız Hava Kompresörü - GPS 1100x4



Sessiz ve Yağsız



Selenoid Valf Sistemi



8 Filtreli



Dijital Gösterge



200 lt Tank



Yüksek Emiş Gücü

Depo Hacmi	:	200 lt
Güç (WATT)	:	1100x4 W
Güç (HP)	:	6 HP
Hava Emişi	:	850 lt/dk
Voltaaj	:	220 V
Ses Düzeyi	:	72 dB
Ağırlık	:	155 kg
Ölçüler	:	129x46x79 cm

300 lt Sessiz ve Yağsız Hava Kompresörü - GPS 1100x6



NEW



Sessiz ve Yağsız



Selenoid Valf Sistemi



12 Filtreli



Dijital Gösterge



300 lt Tank



Yüksek Emiş Gücü

Depo Hacmi	:	300 lt
Güç (WATT)	:	1100x6 W
Güç (HP)	:	9 HP
Basınç	:	8 Bar
Hava Emişi	:	850 lt/dk
Voltaaj	:	220 V
Ses Düzeyi	:	76 dB
Ağırlık	:	190 kg
Ölçüler	:	165x125x60 cm



YÜKSEK EMİŞLİ YAĞSIZ TEKNOLOJİ HAVA KOMPRESÖRLERİ



PROFESYONELLER İÇİN EN İYİ ÇÖZÜMLER
BEST SOLUTIONS FOR PROFESSIONALS

50 Lt Yüksek Emişli Yağsız Teknoloji Hava Kompresörü - GPY 1500x2

NEW

Yüksek Emişli ve Yağsız



Selenoid Valf Sistemi



4 Filtreli



50 Lt Tank



Ergonomik Dizayn

Depo Hacmi	:	50 Lt
Güç (WATT)	:	1500x2 W
Güç (HP)	:	4 HP
Basınç	:	8 Bar
Hava Emişi	:	550 lt/dk
Voltaj	:	220 V
Ses Düzeyi	:	72 dB
Ağırlık	:	39 kg
Ölçüler	:	67X32X69 cm

100 Lt Yüksek Emişli Yağsız Teknoloji Hava Kompresörü - GPY 1500x3

NEW

Yüksek Emişli ve Yağsız



Selenoid Valf Sistemi



6 Filtreli



Ergonomik Dizayn



100 Lt Tank



Dijital Gösterge

Depo Hacmi	:	100 Lt
Güç (WATT)	:	1500x3 W
Güç (HP)	:	6 HP
Basınç	:	8 Bar
Hava Emişi	:	750 lt/dk
Voltaj	:	220 V
Ses Düzeyi	:	75 dB
Ağırlık	:	85 kg
Ölçüler	:	112x45x75 cm

200 Lt Yüksek Emişli Yağsız Teknoloji Hava Kompresörü - GPY 1500x3 /200

NEW



Yüksek Emişli ve Yağsız



Selenoid Valf Sistemi



6 Filtreli



Ergonomik Dizayn



100 Lt Tank



Dijital Gösterge

Depo Hacmi	:	200 lt
Güç (WATT)	:	1500x3 W
Güç (HP)	:	6 hp
Basınç	:	8 bar
Hava Emişi	:	750 lt / dk
Voltaj	:	220 v
Ses Düzeyi	:	75 db
Ağırlık	:	130 kg
Ölçüler	:	129x46x79

200 Lt Yüksek Emişli Yağsız Teknoloji Hava Kompresörü - GPY 1500x4

NEW



Yüksek Emişli ve Yağsız



Selenoid Valf Sistemi



8 Filtreli



Ergonomik Dizayn



200 Lt Tank



Dijital Gösterge

Depo Hacmi	:	200 lt
Güç (WATT)	:	1500x4 W
Güç (HP)	:	8 HP
Basınç	:	8 Bar
Hava Emişi	:	1000 lt/dk
Voltaj	:	220 V
Ses Düzeyi	:	77 dB
Ağırlık	:	146 kg
Ölçüler	:	129x46x79 cm

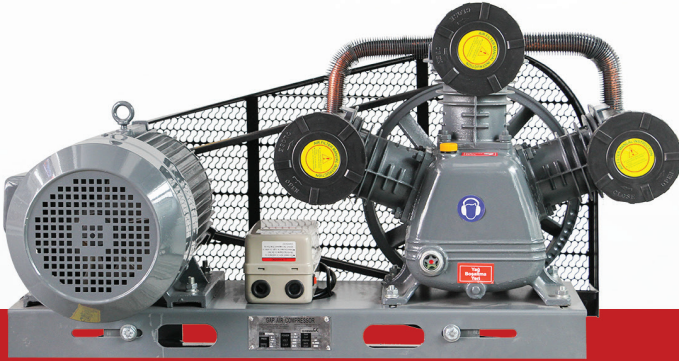

KOMPRESÖR KAFA GRUBU



PROFESYONELLER İÇİN EN İYİ ÇÖZÜMLER
BEST SOLUTIONS FOR PROFESSIONALS

G 750W

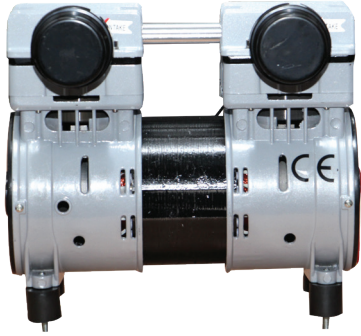

Güç (WATT)	:	750 W
Güç (HP)	:	1 HP
Basınç	:	8 Bar
Hava Emişi	:	175 lt/dk
Voltaj	:	220 V



Çift Filtre

G 1100W / G 1500W

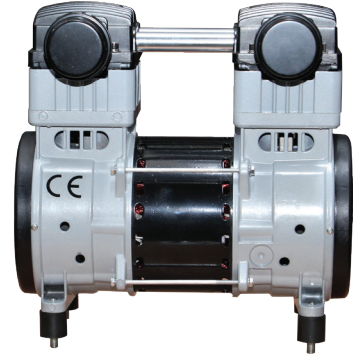

	G 1100W	G 1500W
Güç (WATT)	: 1100 W	1500 W
Güç (HP)	: 1.5 HP	2 HP
Basınç	: 8 Bar	8 Bar
Hava Emişi	: 225 lt/dk	300 lt/dk
Voltaj	: 220 V	220 V



Çift Filtre

2800 Devir - GYD 1500W

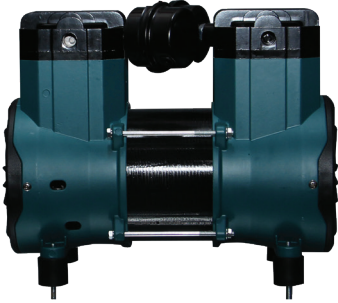

Güç (WATT)	:	1500 W
Güç (HP)	:	2 HP
Basınç	:	8 Bar
Hava Emişi	:	275 lt/dk
Voltaj	:	220 V



Çift Filtre



Ergonomik
Dizayn



Güçlendirilmiş Emiş Gücü

G 2065



Basınç	:	8 Bar
Hava Emişi	:	475 lt/dk
Piston Çapı	:	65 mm
Silindir Sayısı	:	2
2.2 KW elektrik motoru ve 200 Litre depo ile kullanıma uygun		

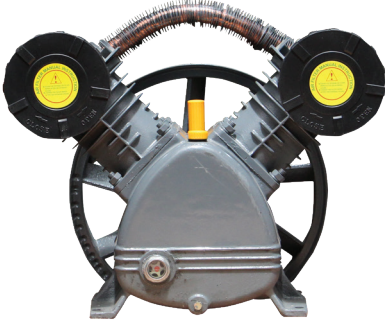

Döküm Gövde

G 2090

Basınç	:	8 Bar
Hava Emişi	:	750 lt/dk
Piston Çapı	:	90 mm
Silindir Sayısı	:	2
4 KW elektrik motoru ve 300 Litre depo ile kullanıma uygun		

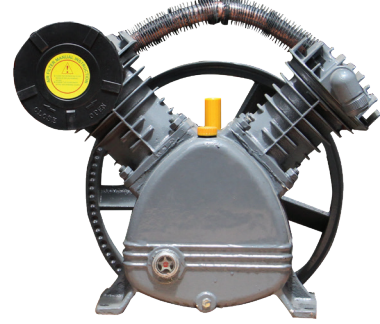
**Döküm Gövde****GK 2090**

Basınç	:	8 Bar
Hava Emişi	:	550 lt/dk
Piston Çapı	:	90/65 mm
Silindir Sayısı	:	2
4 KW elektrik motoru ve 300 Litre depo ile kullanıma uygun		

**Döküm Gövde****G 3090**

Basınç	:	8 Bar
Hava Emişi	:	1200 lt/dk
Piston Çapı	:	90 mm
Silindir Sayısı	:	3
7.5 KW elektrik motoru ve 500 Litre depo ile kullanıma uygun		

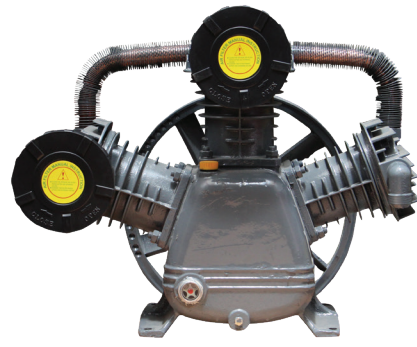
**Döküm Gövde****GK 3090**

Basınç	:	12 Bar
Hava Emişi	:	900 lt/dk
Piston Çapı	:	90/65 mm
Silindir Sayısı	:	3
7.5 KW elektrik motoru ve 500 Litre depo ile kullanıma uygun		

**Döküm Gövde**

G 2090B



Güç	:	4 KW / 5.5 HP
Basınç	:	8 Bar
Hava Emişi	:	750 lt/dk
Voltaj	:	380 V
Piston Çapı	:	90 mm
Silindir Sayısı	:	2
300 Litre depo ile kullanıma uygun		

GK 2090B



Güç	:	4 KW / 5.5 HP
Basınç	:	12 Bar
Hava Emişi	:	550 lt/dk
Voltaj	:	380 V
Piston Çapı	:	90/65 mm
Silindir Sayısı	:	2
300 Litre depo ile kullanıma uygun		

G 3090B

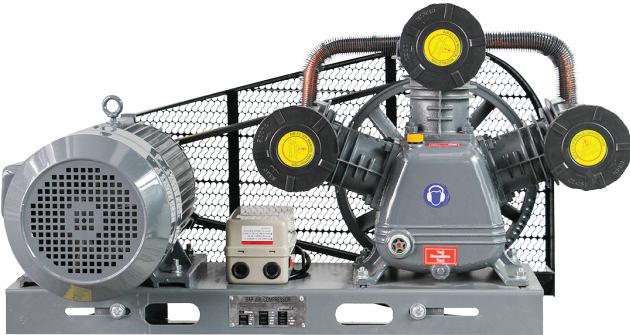

Güç	:	7.5 KW / 10 HP
Basınç	:	8 Bar
Hava Emişi	:	1200 lt/dk
Voltaj	:	380 V
Piston Çapı	:	90 mm
Silindir Sayısı	:	3
500 Litre depo ile kullanıma uygun		

GK 3090B

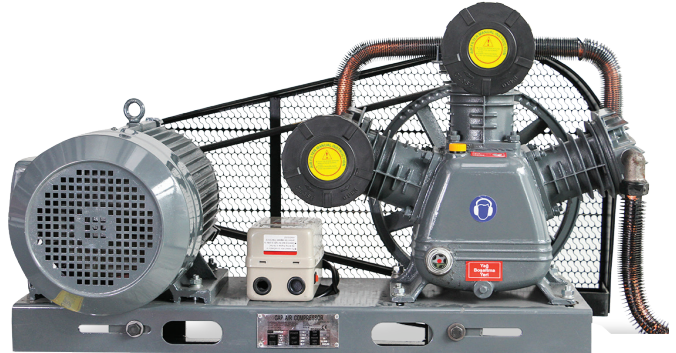

Güç	:	7.5 KW / 10 HP
Basınç	:	12 Bar
Hava Emişi	:	900 lt/dk
Voltaj	:	380 V
Piston Çapı	:	90/65 mm
Silindir Sayısı	:	3
500 Litre depo ile kullanımına uygun		



VİDALI HAVA KOMPRESÖRLERİ



PROFESYONELLER İÇİN EN İYİ ÇÖZÜMLER
BEST SOLUTIONS FOR PROFESSIONALS

10 HP 500 lt Vidalı Hava Kompresörü - GPV 10 A



Direkt Akuple



Dijital Ekran



Kolay Kullanım



500 lt Tank



Minimum Isı



Minimum Ses



Minimum Enerji



Maksimum Performans

Depo Hacmi	:	500 lt
Güç	:	7.5 KW / 10 HP
Voltaj	:	380 V
Basınç	:	8 Bar
Hava Emişi	:	1200 lt/dk
Ses Düzeyi	:	60 dB
Ağırlık	:	210 kg
Ölçüler	:	88x67x88 cm

15 HP 500 lt Vidalı Hava Kompresörü - GPV 15 A



Direkt Akuple



Dijital Ekran



Kolay Kullanım



500 lt Tank



Minimum Isı



Minimum Ses



Minimum Enerji



Maksimum Performans

Depo Hacmi	:	500 lt
Güç	:	11 KW / 15 HP
Voltaj	:	380 V
Basınç	:	8 Bar
Hava Emişi	:	1800 lt/dk
Ses Düzeyi	:	62 dB
Ağırlık	:	320 kg
Ölçüler	:	108x75x100 cm

20 HP 1000 lt Vidalı Hava Kompresörü - GPV 20 A



Direkt Akuple



Dijital Ekran



Kolay Kullanım



1000 lt Tank



Minimum Isı



Minimum Ses



Minimum Enerji



Maksimum Performans

Depo Hacmi	:	1000 lt
Güç	:	15 KW / 20 HP
Voltaj	:	380 V
Basınç	:	8 Bar
Hava Emişi	:	2600 lt/dk
Ses Düzeyi	:	64 dB
Ağırlık	:	340 kg
Ölçüler	:	108x75x100 cm



İsteğe Göre İnvertörlü

30 HP 1000 lt Vidalı Hava Kompresörü - GPV 30 A

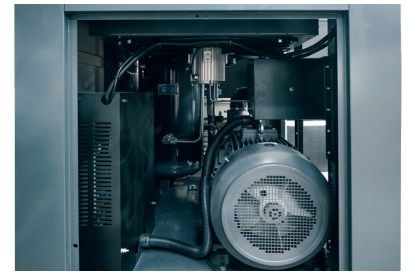

Direkt Akuple



Dijital Ekran



Kolay Kullanım



1000 lt Tank



Minimum Isı



Minimum Ses



Minimum Enerji



Maksimum Performans

Depo Hacmi	:	1000 lt
Güç	:	22 KW / 30 HP
Voltaj	:	380 V
Basınç	:	8 Bar
Hava Emişi	:	3700 lt/dk
Ses Düzeyi	:	68 dB
Ağırlık	:	420 kg
Ölçüler	:	128x85x116 cm



İsteğe Göre İnvertörlü

50 HP 1000 lt Vidalı Hava Kompresörü - GPV 50 A

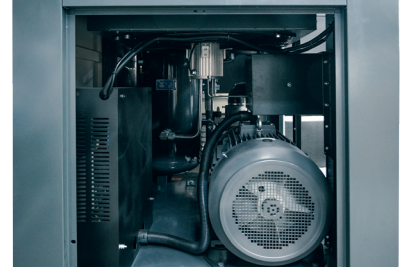

Direkt Akuple



Dijital Ekran



Kolay Kullanım



1000 lt Tank



Minimum Isı



Minimum Ses



Minimum Enerji



Maksimum Performans

Depo Hacmi	:	1000 lt
Güç	:	37 KW / 50 HP
Voltaaj	:	380 V
Basınç	:	8 Bar
Hava Emişi	:	6500 lt/dk
Ses Düzeyi	:	72 dB
Ağırlık	:	580 kg
Ölçüler	:	140x100x129 cm



İsteğe Göre İnvertörlü

75 HP 2000 lt Vidalı Hava Kompresörü - GPV 75 E



Direkt Akuple



Dijital Ekran



Kolay Kullanım



2000 lt Tank



Minimum Isı



Minimum Ses



Minimum Enerji



Maksimum Performans

Depo Hacmi	:	2000 lt
Güç	:	55 KW / 75 HP
Voltaaj	:	380 V
Basınç	:	8 Bar
Hava Emişi	:	9600 lt/dk
Ses Düzeyi	:	75 dB
Ağırlık	:	850 kg
Ölçüler	:	168x115x144 cm



İnvertörlü

100 HP 2000 lt Vidalı Hava Kompresörü - GPV 100 E



Direkt Akuple



Dijital Ekran



Kolay Kullanım



2000 lt Tank



Minimum Isı



Minimum Ses



Minimum Enerji



Maksimum Performans

Depo Hacmi	:	2000 lt
Güç	:	75 KW / 100 HP
Voltaaj	:	380 V
Basınç	:	8 Bar
Hava Emişi	:	12600 lt/dk
Ses Düzeyi	:	77 dB
Ağırlık	:	1050 kg
Ölçüler	:	185x126x156 cm



Invertörlü

Vidalı Hava Kompresörü Bağlantı Örneği

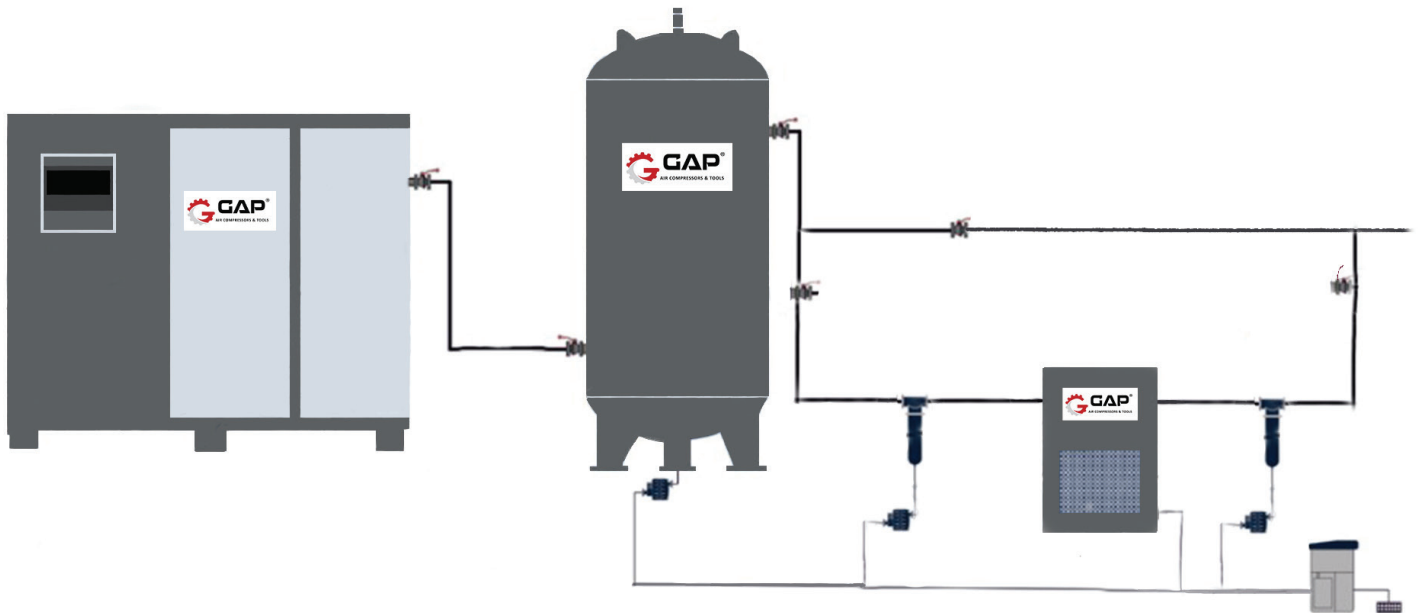



HAVA KURUTUCULARI



PROFESYONELLER İÇİN EN İYİ ÇÖZÜMLER
BEST SOLUTIONS FOR PROFESSIONALS

Hava Kurutucu - GPHK 1200/1800

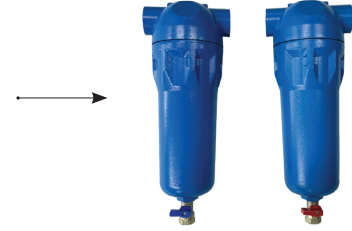

Çift Filtreli



Dijital Ekran



Otomatik Tahliye

Model	:	GPHK 1200	GPHK 1800
Kapasite	:	1.2 m3/dk	1.8 m3/dk
Maks. Hava Basıncı	:	16 Bar	16 Bar
Maks. Çalışma Isısı	:	45 °C	45 °C
Maks. Kurutma	:	3 °C	3 °C
Güç	:	16 HP - 2.2 Bar	16 HP - 2.2 Bar
Voltaj	:	220 V	220 V
Ölçüler	:	65x50x40 cm	65x50x40 cm

Hava Kurutucu - GPHK 2600/3700

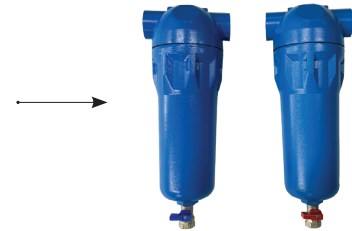

Çift Filtreli



Dijital Ekran



Otomatik Tahliye

Model	:	GPHK 2600	GPHK 3700
Kapasite	:	2.6 m3/dk	3.7 m3/dk
Maks. Hava Basıncı	:	16 Bar	16 Bar
Maks. Çalışma Isısı	:	45 °C	45 °C
Maks. Kurutma	:	3 °C	3 °C
Güç	:	16 HP - 2.2 Bar	16 HP - 2.2 Bar
Voltaj	:	220 V	220 V
Ölçüler	:	95x55x40 cm	95x55x40 cm

Hava Kurutucu - GPHK 6500/8500

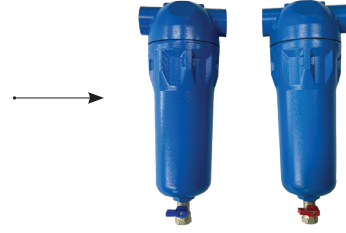

Çift Filtreli



Dijital Ekran



Otomatik Tahliye

Model	:	GPHK 6500	GPHK 8500
Kapasite	:	6.5 m ³ /dk	8.5 m ³ /dk
Maks. Hava Basıncı	:	16 Bar	16 Bar
Maks. Çalışma Isısı	:	45 °C	45 °C
Maks. Kurutma	:	3 °C	3 °C
Güç	:	16 HP - 2.2 Bar	16 HP - 2.2 Bar
Voltaj	:	220 V	220 V
Ölçüler	:	105x75x50 cm	105x75x50 cm

Hava Kurutucu - GPHK 11000/13000

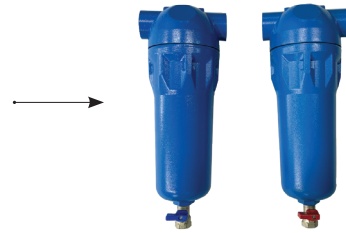

Çift Filtreli



Dijital Ekran



Otomatik Tahliye

Model	:	GPHK 11000	GPHK 13000
Kapasite	:	11 m ³ /dk	13 m ³ /dk
Maks. Hava Basıncı	:	16 Bar	16 Bar
Maks. Çalışma Isısı	:	45 °C	45 °C
Maks. Kurutma	:	3 °C	3 °C
Güç	:	16 HP - 2.2 Bar	16 HP - 2.2 Bar
Voltaj	:	220 V	220 V
Ölçüler	:	107x100x70 cm	107x100x70 cm



ARAÇ KALDIRMA LİFTLERİ



PROFESYONELLER İÇİN EN İYİ ÇÖZÜMLER
BEST SOLUTIONS FOR PROFESSIONALS

4 Ton İki Sutunlu Yarı Otomatik Hidrolik Lift - GPL 101

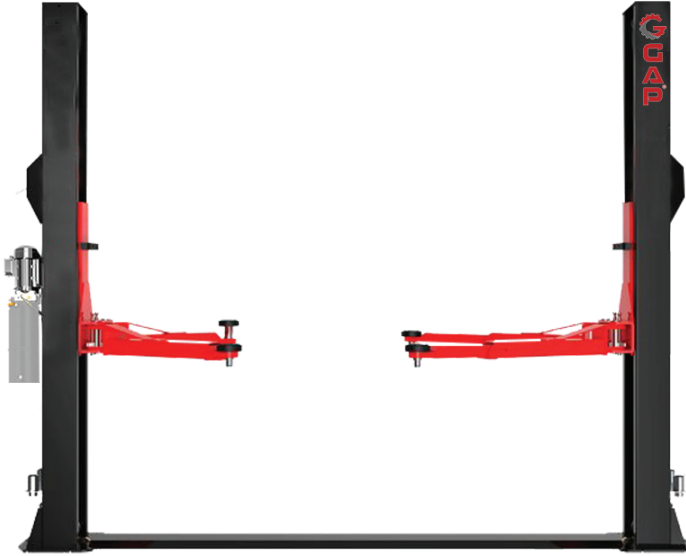

Kaldırma Kapasitesi	:	4 Ton
Kontrol	:	Yarı Otomatik
Max. Kaldırma Yüksekliği	:	1800 mm
Ara Mesafe	:	2850 mm
Dıştan Dışa Lift Ölçüsü	:	3340 mm
Sutun Yüksekliği	:	2830 mm
Sutun Genişliği	:	430 mm
Kısa Kol Ölçüsü	:	710 - 1050 mm
Uzun Kol Ölçüsü	:	760 - 1200 mm
Kaldırma Süresi	:	55 sn
İndirme Süresi	:	26 sn
Motor Gücü	:	2.2 Kw
Voltaj	:	380V/220V
Ağırlık	:	525 kg
Ambalajlı Ölçüsü	:	285x45x70 cm

4 Ton İki Sutunlu Tam Otomatik Hidrolik Lift - GPL 102



Kaldırma Kapasitesi	:	4 Ton
Kontrol	:	Tam Otomatik
Max. Kaldırma Yüksekliği	:	1800 mm
Ara Mesafe	:	2850 mm
Dıştan Dışa Lift Ölçüsü	:	3340 mm
Sutun Yüksekliği	:	2830 mm
Sutun Genişliği	:	430 mm
Kısa Kol Ölçüsü	:	710 - 1050 mm
Uzun Kol Ölçüsü	:	760 - 1200 mm
Kaldırma Süresi	:	55 sn
İndirme Süresi	:	26 sn
Motor Gücü	:	2.2 Kw
Voltaj	:	380V/220V
Ağırlık	:	550 kg
Ambalajlı Ölçüsü	:	285x45x70 cm

4 Ton İki Sutunlu Şaseli Tam Otomatik Hidrolik Lift - GPL 102H

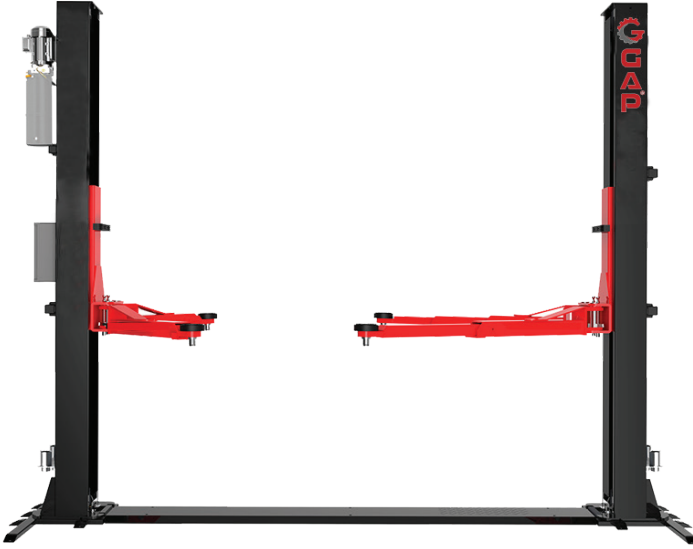

Kaldırma Kapasitesi	:	4 Ton
Kontrol	:	Tam Otomatik
Max. Kaldırma Yüksekliği	:	1800 mm
Ara Mesafe	:	2850 mm
Dıştan Dışa Lift Ölçüsü	:	3340 mm
Sutun Yüksekliği	:	2830 mm
Sutun Genişliği	:	430 mm
Kısa Kol Ölçüsü	:	710 - 1050 - 1200 mm
Uzun Kol Ölçüsü	:	760 - 1200 - 1500 mm
Kaldırma Süresi	:	55 sn
İndirme Süresi	:	26 sn
Motor Gücü	:	2.2 Kw
Voltaaj	:	380V/220V
Ağırlık	:	650 kg
Ambalajlı Ölçüsü	:	285x45x70 cm



Üç Kademeli Uzun Kol



Güçlendirilmiş Şase

4 Ton İki Sutunlu Üstten Bağlantılı Tam Otomatik Hidrolik Lift - GPL 102U



Kaldırma Kapasitesi	:	4 Ton
Kontrol	:	Tam Otomatik
Max. Kaldırma Yüksekliği	:	1800 mm
Ara Mesafe	:	2900 mm
Dıştan Dışa Lift Ölçüsü	:	3450 mm
Sutun Yüksekliği	:	3885 mm
Sutun Genişliği	:	430 mm
Kısa Kol Ölçüsü	:	710 - 1050 - 1200 mm
Uzun Kol Ölçüsü	:	760 - 1200 - 1500 mm
Kaldırma Süresi	:	55 sn
İndirme Süresi	:	26 sn
Motor Gücü	:	2.2 Kw
Voltaaj	:	380V/220V
Ağırlık	:	650 kg
Ambalajlı Ölçüsü	:	280x7x45 cm



Üç Kademeli Uzun Kol



Şasesiz Taban Kullanım Kolaylığı

5 Ton İki Sütunlu Tam Otomatik Hidrolik Lift - GPL 104

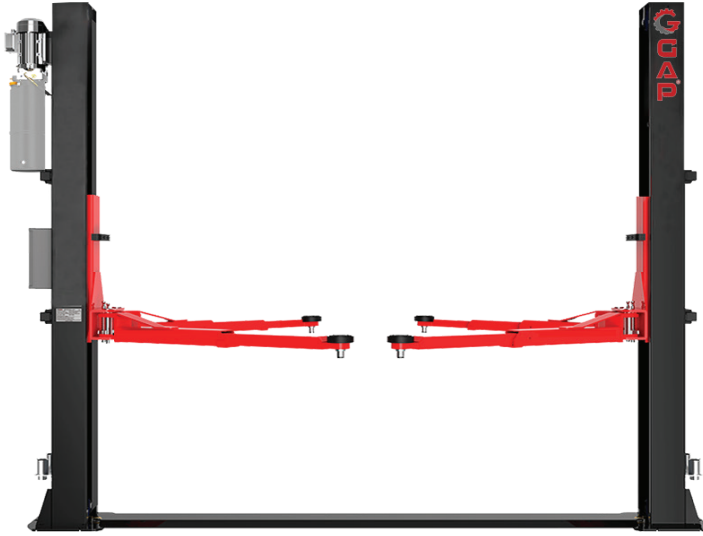

Kaldırma Kapasitesi	:	5 Ton
Kontrol	:	Tam Otomatik
Max. Kaldırma Yüksekliği	:	1800 mm
Ara Mesafe	:	3300 mm
Dıştan Dışa Lift Ölçüsü	:	3888 mm
Sutun Yüksekliği	:	2920 mm
Sutun Genişliği	:	520 mm
Kısa Kol Ölçüsü	:	760 - 1200 - 1500 mm
Uzun Kol Ölçüsü	:	800 - 1400 - 1800 mm
Kaldırma Süresi	:	55 sn
İndirme Süresi	:	26 sn
Motor Gücü	:	2.2 Kw
Voltaj	:	380V/220V
Ağırlık	:	950 kg
Ambalajlı Ölçüsü	:	290x50x75 cm



Üç Kademeli Uzun Kol



Güçlendirilmiş Sütunlar ve Kollar

3,5 Ton Tam Otomatik Hidrolik Makaslı Lift - GPL 103



Kaldırma Kapasitesi	:	3.5 Ton
Kontrol	:	Tam Otomatik
Max. Kaldırma Yüksekliği	:	1850 mm
Ara Mesafe	:	800 mm
Dıştan Dışa Lift Ölçüsü	:	2000 mm
Tabla Uzunluğu	:	1525 mm
Tabla Eni	:	60 mm
Rampa Uzunluğu	:	290 mm
Motor Gücü	:	2.2 Kw
Voltaj	:	380V/220V
Ağırlık	:	900 kg
Ambalajlı Ölçüsü 1	:	170x70x40 cm
Ambalajlı Ölçüsü 2	:	100x40x35 cm



Arttırılmış Güvenlik Havalı Kilit Sistemi



Kablolu Uzaktan Kontrol



Güçlendirilmiş Makaslar



OTO SERVİS EKİPMANLARI



PROFESYONELLER İÇİN EN İYİ ÇÖZÜMLER
BEST SOLUTIONS FOR PROFESSIONALS

İki Ton Katlanır Vinç - GPT 101



- ✓ Katlanabilir
- ✓ Kapasite : 2 Ton
- ✓ Kaldırma Aralığı : 25 - 2000 mm
- ✓ Maksimum Yükseklik : 1750 mm
- ✓ Ambalajlı Ölçüsü 1 : 650x580x90 mm
- ✓ Ambalajlı Ölçüsü 2 : 1440x300x160 mm
- ✓ Ağırlık : 75 Kg

GPT 102

3 Ton Alçak Şase Garaj Krikosu



- ✓ Çift Piston
- ✓ Kapasite : 3 Ton
- ✓ Minimum Yükseklik : 75 mm
- ✓ Maksimum Yükseklik : 505 mm
- ✓ Ambalajlı Ölçüsü : 805x370x205 mm
- ✓ Ağırlık : 34 Kg

GPT 103

0.5 Ton Dikey Şanzıman Kriko



- ✓ Otomatik Frenli
- ✓ Kapasite : 0.5 Ton
- ✓ Minimum Yükseklik : 1130 mm
- ✓ Maksimum Yükseklik : 1940 mm
- ✓ Ambalajlı Ölçüsü : 1080x290x160 mm
- ✓ Ağırlık : 30 Kg

GPT 104

450 Kg Motor Standı



- ✓ Kapasite : 1000 Lbs - 450 Kg
- ✓ Çalışma Yüksekliği : 880 mm
- ✓ Ambalajlı Ölçüsü : 900x210x180 mm
- ✓ Ağırlık : 15 Kg

GPT 105

650 Kg Motor Standı



- ✓ Kapasite : 1250 Lbs - 650 Kg
- ✓ Çalışma Yüksekliği : 880 mm
- ✓ Ambalajlı Ölçüsü : 900x240x210 mm
- ✓ Ağırlık : 25 Kg

GPT 106/106H

Helezon Yay Çektirme



- ✓ Kapasite : 1 Ton
- ✓ Sıkıştırma Aralığı : 210 - 570 mm
- ✓ Ambalajlı Ölçüsü : 1270x300x200 mm
- ✓ Ağırlık : 32 Kg
- ✓ İsteğe Bağlı Havalı Model

GPT 107/108

3 - 6 Ton Kriko Standı



Geniş Ayaklı



- GPT 107 - 3 Ton
- GPT 108 - 6 Ton
- ✓ 3 Ton Kaldırma Aralığı : 288 - 425 mm
- ✓ 6 Ton Kaldırma Aralığı : 395 - 605 mm
- ✓ 3 Ton Ambalajlı Ölçüsü : 195x195x350 mm
- ✓ 6 Ton Ambalajlı Ölçüsü : 280x240x420 mm

GPT 109

4 Ton Hidrolik Doğrultma



- ✓ Plastik Çantalı
- ✓ Hareket Mesafesi : 125 mm
- ✓ Ambalajlı Ölçüsü : 600x320x180 mm
- ✓ Ağırlık : 18 Kg

GPT 110

10 Ton Hidrolik Doğrultma



- ✓ Plastik Çantalı
- ✓ Hareket Mesafesi : 125 mm
- ✓ Ambalajlı Ölçüsü : 730x310x175 mm
- ✓ Ağırlık : 28 Kg

Araç Altı Ledli Bakım Sehпасı - **GPT 111**



- ✓ Led Lambalı ✓ Cepli ✓ Ağırlık : 5 Kg
- ✓ Ölçüler : 1010x475x130 mm

Araç Altı Katlanır Bakım Sehпасı - **GPT 112**



- ✓ Katlanır ✓ Ağırlık : 7 Kg
- ✓ Ölçüler : 1020x440x120 mm

Araç Altı Bakım Sehпасı - **GPT 113**



- ✓ Sırt Ayarlı ✓ Ağırlık : 7 Kg
- ✓ Ölçüler : 1020x425x110 mm

3 Ton Yüksek Şase Garaj Krikosu - GPT 114



- ✓ Hidrolik Piston
- ✓ Kapasite : 3 Ton
- ✓ Minimum Yükseklik : 130 mm
- ✓ Maksimum Yükseklik : 500 mm
- ✓ Ağırlık : 60 Kg

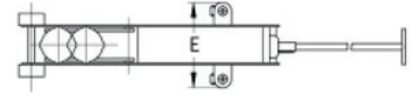
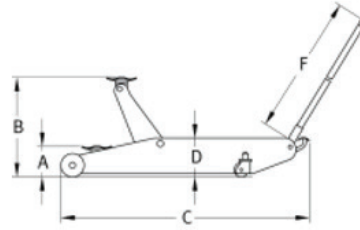

A	B	C	D	E	F
13 Cm	50 Cm	138 Cm	18 cm	38 Cm	103 Cm

5 Ton Yüksek Şase Garaj Krikosu - GPT 115



- ✓ Hidrolik Piston
- ✓ Kapasite : 5 Ton
- ✓ Minimum Yükseklik : 130 mm
- ✓ Maksimum Yükseklik : 550 mm
- ✓ Ağırlık : 70 Kg

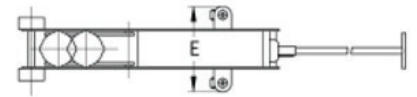
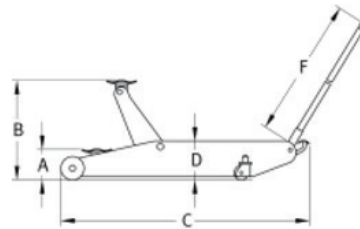

A	B	C	D	E	F
13 Cm	55 Cm	150 Cm	18 cm	38 Cm	104 Cm

Kollu Manuel Hidrolik Pres 10 Ton - GPT 116

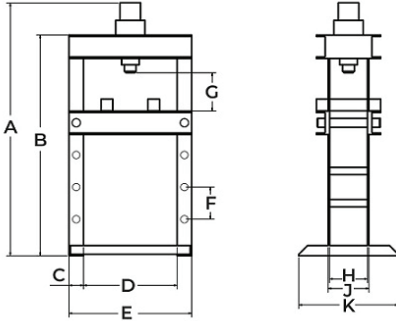

A	B	C	D	E	F	G	H	J	K
87 Cm	76 Cm	5 Cm	32 Cm	43 Cm	11 Cm	15 Cm	15 Cm	17 Cm	45 Cm

Yüksek kaliteli çelikten imal edilmiştir, H tipi çerçeveye sahiptir.

Uzun ömürlü olması ve paslanmayı önlemeye yardımcı olmak için kimyasal yıkamadan sonra boyanmıştır. Kolay temizlik için yağa, grese dayanıklıdır.

Geniş çaplı hidrolik çelik silindir ünitesi, yükü kaldırmak için gereken daha düşük yağ basıncı sağlayarak aşınmayı azaltmaya ve hizmet ömrünü uzatmaya yardımcı olur, kolay pompalama için sap dahildir.



Kollu Manuel Hidrolik Pres 15 Ton - GPT 117

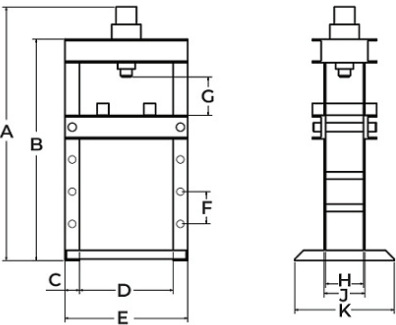

A	B	C	D	E	F	G	H	J	K
157 Cm	147 Cm	5 Cm	46 Cm	59 Cm	16 Cm	15 Cm	15 Cm	18 Cm	50 Cm

Yüksek kaliteli çelikten imal edilmiştir, H tipi çerçeveye sahiptir.

Uzun ömürlü olması ve paslanmayı önlemeye yardımcı olmak için kimyasal yıkamadan sonra boyanmıştır. Kolay temizlik için yağa, grese dayanıklıdır.

Geniş çaplı hidrolik çelik silindir ünitesi, yükü kaldırmak için gereken daha düşük yağ basıncı sağlayarak aşınmayı azaltmaya ve hizmet ömrünü uzatmaya yardımcı olur, kolay pompalama için sap dahildir.



Kollu Manuel Hidrolik Pres 30 Ton - GPT 118

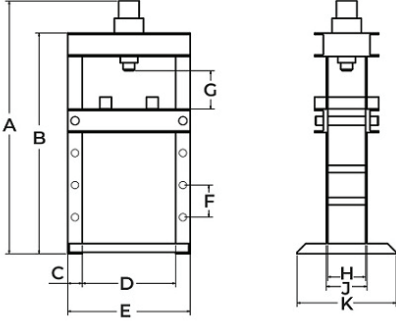

Yüksek kaliteli çelikten imal edilmiştir, H tipi çerçeveye sahiptir.

Uzun ömürlü olması ve paslanmayı önlemeye yardımcı olmak için kimyasal yıkamadan sonra boyanmıştır. Kolay temizlik için yağa, grese dayanıklıdır.

Geniş çaplı hidrolik çelik silindir ünitesi, yükü kaldırmak için gereken daha düşük yağ basıncı sağlayarak aşınmayı azaltmaya ve hizmet ömrünü uzatmaya yardımcı olur, kolay pompalama için sap dahildir.



A	B	C	D	E	F	G	H	J	K
170 Cm	155 Cm	6 Cm	63 Cm	74 Cm	13 Cm	19 Cm	18 Cm	22 Cm	60 Cm



Turlu Şanzıman Pompası - GP D101



Kapasite	18 lt
Verim	250 gr/tur
Çalışma Şekli	2 Tur ileri - 2 Tur Geri

ÜRÜN	EBAT	AĞIRLIK
GP-D101 Tuşlu Şanzıman Pompası	33x33x72 cm	18 kg

Havalı Yağ Boşaltma Pompası - GP YB102



Kapasite	60/80 lt
Azami Yükseklik	160 cm
Çalışma Şekli	Havalı

ÜRÜN	EBAT	AĞIRLIK
GP-YB102 Havalı Yağ Boşaltma Pompası 80lt	50x50x95 cm	18 kg

Karterden Yağ Emme Hunili - GP K103



Hava Sarfiyatı	80-90 lt/dk
Hortum Uzunluğu	2 m
Çalışma Basıncı	6-8 Atü
Verim	3 lt/dk

ÜRÜN	EBAT	AĞIRLIK
GP-K103 80 lt Karterden Yağ Emme Hunili	50x55x120 cm	31 kg



LASTİK SÖKME VE BALANS MAKİNELERİ



PROFESYONELLER İÇİN EN İYİ ÇÖZÜMLER
BEST SOLUTIONS FOR PROFESSIONALS

Binek Araç Lastik Sökme Takma Makinası - GLS 850

TEKNİK ÖZELLİKLER

- 10''-24'' Arası Jant Bağlama İmkanı
- Binek Ve Hafif Ticari Lastiklere Hizmet Eder
- 380 Volt Motor Gücü, Opsiyonel 220 Volt
- Dönüş Hızı 8-16 Rpm (2 Devir)
- Çalışma Basıncı : 8-10 Bar
- Opsiyonel Çift Devir
- Ağırlık 228 Kg
- Ambalaj Ölçüleri 110x1155 Cm
- Opsiyonel Plus Aparatı Ve Şoklama
- Standart Levye



Binek Araç Lastik Sökme Takma Makinası - GLS 880

TEKNİK ÖZELLİKLER

- 10''-26'' Arası Jant Bağlama İmkanı
- Binek Ve Hafif Ticari Lastiklere Hizmet Eder
- 380 Volt Motor Gücü
- Dönüş Hızı 16 Rpm (2 Devir)
- Çalışma Basıncı : 8-10 Bar
- Hava Pedal Kontrolle Geriye Yatan Kafa
- Montaj Kafası Ve Damak Düşürme Koruma Plastikleri
- Hava Saati Ve Raf Sistemi
- Opsiyonel Plus Aparatı Ve Şoklama
- Standart Levye



Binek Araç Lastik Balans Makinası - GBM 989

TEKNİK ÖZELLİKLER

- 19" LCD Ekran
- İç Otomatik Ölçüm Kolu
- Dış Otomatik Ölçüm Kolu
- Frenleme Sistemi
- Maks. Tekerlek Ağırlığı 65 Kg
- Motor Gücü 0.25 kw
- Balans Hızı 180 Rpm
- Devir Süresi 7 sn
- Güç Kaynağı 220v ph 50/65 Hza
- Dengeleme Hassaslığı 1 gr
- Jant Çapı 12"-24"
- Jant Genişliği 1.5"-2.0"
- Paket Ölçüleri 950x750x1160mm



Binek Araç Lastik Balans Makinası - GBM 32

TEKNİK ÖZELLİKLER

- 19" LCD Ekran
- Türkçe Kolay Ve Pratik Menü
- Çok Fonksiyonlu Joystick
- Otomatik İç Ölçüm Kolu
- Otomatik Lazerli Sonarlı Çap Ölçümü
- Davlumbazla Otomatik Start/Stop
- Led Işıklarla Jant İçi Aydınlatma
- Havalı Jant Sıkıştırma
- Jant Aralığı 10" - 32"
- Maks. Ağırlık 70 Kg
- Dönüş Hızı 150 Rpm
- Güç Tüketimi 220V





KAPORTA ÇEKTİRME MAKİNELERİ



PROFESYONELLER İÇİN EN İYİ ÇÖZÜMLER
BEST SOLUTIONS FOR PROFESSIONALS

Kaporta Çektirme Makinesi - GC 5000

Otomobillerin kapı, çamurluk, kaporta vb. kısımlarında oluşan göçükleri düzeltmek için tasarlanmış, portatif, basit kullanımlı, dayanıklı ve kademe kontrollü kaporta çektirme makinasıdır.

TEKNİK ÖZELLİKLER

Şebeke Gerilimi	1 Faz, 220 V 50 Hz.
Açık Devre Gerilimi	8,5 V
Gerekli Şebeke Sigortası	1x40 A (C Tipi)
Maximum Giriş Gücü	5 kVA
Çektirme Kapasitesi	0,60 ila 0,80 mm
İzolasyon Sınıfı	H
Koruma Sınıfı	IP 21 sn
Boyutlar (e/d/y) (cm)	24x35x31
Ağırlık	26 kg

ÜRÜN ÖZELLİKLERİ

Yüksek transformatör gücü
 5 kademeli akım ayar şalteri
 Plastik aparat kabzesi ile elektrik çarpmalarına karşı önlem
 Özel üretim sarı malzemeden yapılmış çektirme aparatı ve şase bağlantı bakırı



Makine İle Birlikte Verilen Aksesuarlar

- ✓ Çektirme Aparatı
- ✓ Şase Bağlantı Bakırı
- ✓ 2 m Aparat Güç Kablosu
- ✓ 2 m Şase Kablosu

Kaporta Çektirme Makinesi - GC 10000

Otomobillerin, otobüslerin ve kamyonların kapı, çamurluk, kaporta vb. kısımlarında, kamyon ve tır dorselerinde oluşan göçükleri düzeltmek için tasarlanmış, basit kullanımlı, dayanıklı ve kademe kontrollü profesyonel tip kaporta çektirme makinasıdır.

TEKNİK ÖZELLİKLER

Şebeke Gerilimi	1 Faz, 220 V 50 Hz.
Açık Devre Gerilimi	7,7 V
Gerekli Şebeke Sigortası	1x40 A (C Tipi)
Maximum Giriş Gücü	10 kVA
Çektirme Kapasitesi	0,80 ila 1,00 mm
Tek Taraflı Punta Kapasitesi	0,60+0,60 mm
İzolasyon Sınıfı	H
Koruma Sınıfı	IP 21 sn
Boyutlar (e/d/y) (cm)	51x53x92
Ağırlık	52 kg

ÜRÜN ÖZELLİKLERİ

Yüksek transformatör gücü
 2 kademe kaba, 5 kademe ince ayar şalteri ile 10 kademeli akım ayarı
 Plastik aparat kabzesi ile elektrik çarpmalarına karşı önlem
 Kullanışlı taşıma arabası ve taşıma arabasından ayrılabilmesi sayesinde esnek kullanım olanağı
 Özel üretim sarı malzemeden yapılmış çektirme aparatı ve şase bağlantı bakırı

Makine İle Birlikte Verilen Aksesuarlar

- ✓ Çektirme Aparatı
- ✓ Zigzag Teli Puntalama Bakırı
- ✓ Şase Bağlantı Bakırı
- ✓ 2 m Aparat Güç Kablosu
- ✓ 2 m Şase Kablosu



Kaporta Çektirme Makinası - GC 12000

Otomobillerin, otobüslerin ve kamyonların kapı, çamurluk, kaporta vb. kısımlarında, kamyon ve tır dorselerinde oluşan göçükleri düzeltmek için tasarlanmış, basit kullanımlı, dayanıklı ve kademe kontrollü profesyonel tip kaporta çektirme makinasıdır.

TEKNİK ÖZELLİKLER

Şebeke Gerilimi	1 Faz, 220 V 50 Hz.
Açık Devre Gerilimi	8,9 V
Gerekli Şebeke Sigortası	1x63 A (C Tipi)
Maximum Giriş Gücü	12 kVA
Çektirme Kapasitesi	0,80 ila 1,20 mm
Tek Taraflı Punta Kapasitesi	0,80+0,80 mm
İzolasyon Sınıfı	H
Koruma Sınıfı	IP 21 sn
Boyutlar (e/d/y) (cm)	51x53x92
Ağırlık	60 kg

ÜRÜN ÖZELLİKLERİ

Yüksek transformatör gücü
 2 kademe kaba, 5 kademe ince ayar şalteri ile 10 kademeli akım ayarı
 Plastik aparat kabzesi ile elektrik çarpmalarına karşı önlem
 Kullanışlı taşıma arabası ve taşıma arabasından ayrılabilmesi sayesinde esnek kullanım olanağı
 Özel üretim sarı malzemeden yapılmış çektirme aparatı ve şase bağlantı bakırı

Makine İle Birlikte Verilen Aksesuarlar

- ✓ Çektirme Aparatı
- ✓ Zigzag Teli Puntalama Bakırı
- ✓ Şase Bağlantı Bakırı
- ✓ 2 m Aparat Güç Kablosu
- ✓ 2 m Şase Kablosu



Kaporta Çektirme Makinası - GC MAX

GP MAX, 10 kVA gücünde elektronik akım ve zaman kontrollü profesyonel kaporta çektirme makinasıdır. Çektirme yapılacak kaporta kalınlığına göre kaportada minimum iz bırakacak şekilde dijital ayar yapılabilir.

TEKNİK ÖZELLİKLER

Şebeke Gerilimi	1 Faz, 220 V 50 Hz.
Açık Devre Gerilimi	7,7 V
Gerekli Şebeke Sigortası	1x25 A (C Tipi)
Maximum Giriş Gücü	10 kVA
Çektirme Kapasitesi	0,30 ila 1,30 mm
İzolasyon Sınıfı	H
Koruma Sınıfı	IP 21 sn
Boyutlar (e/d/y) (cm)	47x50x100
Ağırlık	35 kg

ÜRÜN ÖZELLİKLERİ

Kabze üzerindeki butona basılı tutulsa bile makina ayarlanan süre kadar çıkış verir. Bu sayede çektirme kolu ve kablolar ısınmaz, üçgen pul deforme olmaz ve kaportada büyük izler oluşmaz.

Manuel ve otomatik modu mevcuttur.

Manuel Çalışma: Uç kaportaya temas ettikten ve kabze üzerindeki butona basıldıktan sonra makina çıkış verir.

Otomatik Çalışma: Uç kaportaya temas ettiğinde makina otomatik olarak çıkış verir. Kabze üzerindeki butona basılması gerekmez.

Makine İle Birlikte Verilen Aksesuarlar

- ✓ Çektirme Aparatı
- ✓ Şase Bağlantı Bakırı
- ✓ 4 m 3x2,50 mm² Giriş Kablosu
- ✓ 2 m Aparat Güç Kablosu
- ✓ 2 m Şase Kablosu



Kaporta Çektirme Makinası - GC PRO

GPC PRO, 12 kVA gücünde elektronik akım ve zaman kontrollü profesyonel kaporta çekme makinası setidir. Çekme yapılacak kaporta kalınlığına göre kaportada minimum izi bırakacak şekilde dijital ayar yapılabilir.

TEKNİK ÖZELLİKLER

Şebeke Gerilimi	1 Faz, 220 V 50 Hz.
Açık Devre Gerilimi	7,7 V
Gerekli Şebeke Sigortası	1x32 A (C Tipi)
Maximum Giriş Gücü	12 kVA
Çektirme Kapasitesi	0,30 ila 1,60 mm
İzolasyon Sınıfı	H
Koruma Sınıfı	IP 21 sn
Boyutlar (e/d/y) (cm)	47x50x100
Ağırlık	40 kg

ÜRÜN ÖZELLİKLERİ

Kabze üzerindeki butona basılı tutulsa bile makina ayarlanan süre kadar çıkış verir. Bu sayede çekme kolu ve kablolar ısınmaz, üçgen pul deforme olmaz ve kaportada büyük izler oluşmaz.

Elektronik ünite iki ayrı modda çalıştırılabilir.

Normal Mod: Kullanıcı, malzeme kalınlıklarına göre akım ve zamanı dijital olarak ayarlayabilir.

Sinerjik Mod: spot PRO 7 ayrı sinerjik program ile donatılmıştır. Bu programlar için malzeme kalınlıkları referans alınarak özel yazılımlar geliştirilmiştir.

Manuel ve otomatik modu mevcuttur.

Manuel Çalışma: Uç kaportaya temas ettikten ve kabze üzerindeki butona basıldıktan sonra makina çıkış verir.

Otomatik Çalışma: Uç kaportaya temas ettiğinde makina otomatik olarak çıkış verir. Kabze üzerindeki butona basılması gerekmez.

7 özel programa sahiptir:Üçgen pul ile çekme, zigzag teli puntalama, büyük pul puntalama, küçük yuvarlak pul puntalama, bakır uç ile şiş alma, karbon elektrod ile şiş alma, m5 civata puntalama.

Makine İle Birlikte Verilen Aksesuarlar

- ✓ Çektirme Aparatı
- ✓ Üçgen Pul (5 adet)
- ✓ Zigzag Teli Puntalama Bakırı
- ✓ Zigzag Teli (5 adet)
- ✓ Büyük Pul Puntalama Bakırı
- ✓ Büyük Pul (5 adet)
- ✓ Küçük Yuvarlak Pul Puntalama Bakırı
- ✓ Şase Bağlantı Bakırı
- ✓ Karbon Elektrod (1 adet)
- ✓ 4 m 3x2,50 mm² Giriş Kablosu
- ✓ 2 m Aparat Güç Kablosu
- ✓ 2 m Şase Kablosu
- ✓ 6'lı Aslan Pençesi





TAKIM ARABALARI VE TEZGAHLARI



PROFESYONELLER İÇİN EN İYİ ÇÖZÜMLER
BEST SOLUTIONS FOR PROFESSIONALS

Çekmecesiz Takım Arabası - GPT 201



- ✓ En: 450 mm – Genişlik: 600 mm – Yükseklik: 900 mm ✓ Elektrostatik toz boyalı
- ✓ Toplam taşıma kapasitesi 240 kg ✓ Uygun çalışma alanı sağlayan geniş üst bölüm

Tek Çekmeceli Takım Arabası - GPT 202



- ✓ En: 450 mm – Genişlik: 600 mm – Yükseklik: 900 mm ✓ Elektrostatik toz boyalı ✓ Toplam taşıma kapasitesi 240 kg.
- ✓ Uygun çalışma alanı sağlayan geniş üst bölüm

İki Çekmeceli Takım Arabası - GPT 203



- ✓ En: 450 mm – Genişlik: 600 mm – Yükseklik: 900 mm ✓ Elektrostatik toz boyalı
- ✓ Toplam taşıma kapasitesi 240 kg.
- ✓ Uygun çalışma alanı sağlayan geniş üst bölüm

5 Çekmeceli Takım Arabası - GPT 204



- ✓ En: 450 mm – Genişlik: 600 mm – Yükseklik: 900 mm ✓ Elektrostatik toz boyalı
- ✓ Toplam taşıma kapasitesi 240 kg.
- ✓ Kilit sistemi ✓ Uygun çalışma alanı sağlayan geniş üst bölüm

Endüstriyel Çekmeceli Çalışma Tezgahı - GPT 205/206



1500 mm



2000 mm

- ✓ En: 1500/2000 mm – Genişlik: 650 mm – Yükseklik: 900 mm ✓ Pano Ölçüsü 850 mm ✓ Elektrostatik toz boyalı
- ✓ Toplam taşıma kapasitesi 250 kg. ✓ Led Lamba ✓ 2 adet Prizlik ✓ Avadanlık
- ✓ Uygun çalışma alanı sağlayan geniş üst bölüm

Endüstriyel Dolaplı Çalışma Tezgahı - GPT 207



2000 mm

- ✓ En: 2000 mm – Derinlik: 650 mm – Yükseklik: 900 mm ✓ Pano Ölçüsü 850 mm ✓ Elektrostatik toz boyalı
- ✓ Toplam taşıma kapasitesi 350 kg. ✓ Led Lamba ✓ 2 adet Prizlik ✓ Avadanlık
- ✓ Kilit sistemi ✓ Uygun çalışma alanı sağlayan geniş üst bölüm

FABRİKA SATIŞ HATTIMIZDAN GÖRÜNTÜLER



GAP Topkapı Mağazamız

1997'den günümüze hizmet vermektedir.

GAP İkitelli
Mağazamız

2016'dan
günümüze
hizmet vermektedir.



Zengin Ürün Stoğumuzdan
Anında Teslimat !



A'dan Z'ye Endüstriyel
Ürünler



ÜRETİM HATTIMIZDAN GÖRÜNTÜLER

GAP ailesi olarak 1986 ' dan bu yana hiç durmadan çalışarak, üretim kalitemizi her zaman en üst seviyede tuttuk.



Müşterilerimizin ihtiyaçlarına uygun ve yüksek performanslı ürünler ürettik.

Güvenilir ve uzun ömürlü ürünlerimizle sizlere en iyi çözümleri sunmaya devam ediyoruz.





Katalođumuzu cep telefonunuza
indirmek iin QR kodu okutun !



İkitelli : İkitelli OSB Metal İş San. Sit. Metro 34 İş Merkezi No: 6 Başakşehir - İSTANBUL / TR

Tel : +90 212 556 69 99

Topkapı : Fazıl Paşa Cad. TİM 2 İş Merkezi No: 252 - 263 Topkapı - İSTANBUL / TR

Tel : +90 212 613 86 22

E-posta : info@gapkompresor.com

www.gapkompresor.com

www.gaptools.net